

LIGHTING & WIRING
ACCESSORIES

2021



Established in 1998



Based in
Dunstable, UK



3000+ products
in stock



Available at all
major wholesalers



Award-winning
customer service



Committed to a
brighter future

AT A GLANCE



Knightsbridge

CUSTOMER GUARANTEE

Our aim is to deliver quality products and service in a highly professional manner at all times. We are totally committed to our customers and will endeavour to operate with honesty and integrity, trading fairly throughout our success and continuous improvement...

...and that's a promise!



SERVICE



ALL CALLS ANSWERED
IN 3 RINGS OR LESS



SAME DAY COLLECTION
FROM OUR WAREHOUSE



QUOTES WITHIN
1 HOUR



DELIVER DIRECT TO
YOUR CUSTOMERS
WITH K-DIRECT



5PM CUT OFF NEXT DAY
DELIVERY (MON-THU)
(3PM ON FRIDAYS)



ORDER TRACKING
AVAILABLE



CONTENTS

WIRING ACCESSORIES

Moulded Switches & Sockets	5
Square Edge	6-11
Curved Edge	12-21
Raised Edge Switches & Sockets	23
Rounded Edge	24-36
Square Edge	38-51
Flat Plate Switches & Sockets	52-74
Screwless Switches & Sockets	76-103
Specialist Sockets	106-111
Metal Clad Switches & Sockets	112-119
Datacomms	120-126
Grid Wiring Accessories	128-129
Weatherproof	130-138
Wiring Basics	140-150
Additional Hardware	152-159

SMART HOME	160-169
------------	---------

LIGHTING

Domestic Interior	
Downlights	170-193
Ceiling & Wall Lights	194-205
Bathroom	206-215
Under Cabinet	216-226
LED Flex	228-239
Outdoor Lighting	
Wall Lights	240-260
Spike Lights	262-267
Bollard & Post Lighting	268-269
Groundlights & Deck Lighting	270-278
Outdoor Heating	279
Floodlights	280-288
Commercial Lighting	
Bulkheads & Wall Packs	290-306
Commercial Downlights	308-313
Recessed, Surface & Suspension Lighting	314-321
Battens	322-333
Non-Corrosive	334-342
High Bay / Low Bay	344-345
Emergency Lighting	346-359
Sensors	360-365
Lamps & Lighting Accessories	366-378

INDEX	379-404
-------	---------



MOULDED SWITCHES AND SOCKETS

DOUBLE POLE SWITCHES

On selected products, for additional safety

LASER PRINTED MARKINGS

Leaving a clean finish

ANTIMICROBIAL

Made from a high grade thermoset resin with antimicrobial properties and scratch resistance

SCREW CAP COVERS

Supplied as standard

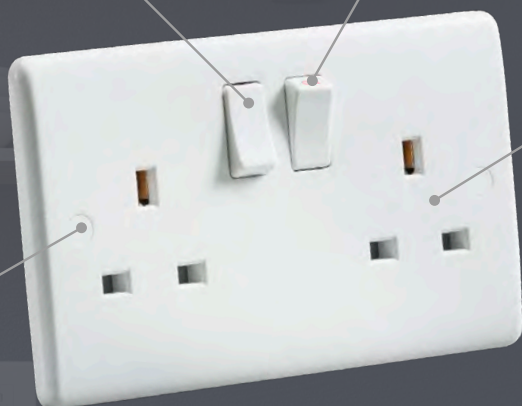

TOP-DOWN TERMINALS

For speedy installations, wiring from just one position



EASY-INSTALL

Quick and easy to install with captive terminals and industry-expected terminal capacities

HIGH INTEGRITY EARTHING

Twin earthing terminals (on double switched sockets), for compliance with BS 7671:2008 regulation 543-7

15

YEAR WARRANTY*

*2 YEARS ON ELECTRONIC PRODUCTS

ALL DETAILS ON THIS PAGE APPLY TO THE SQUARE EDGE AND CURVED EDGE MOULDED SWITCHES AND SOCKETS



Single Plate Size:

86mm x 86mm

Double Plate Size:

86mm x 146mm

Plate Thickness:

9mm (unless otherwise stated)



MOULDED SWITCHES & SOCKETS

SQUARE EDGE

Comprehensive, all-purpose moulded switches and sockets

13A Sockets / Shaver Socket / Sockets with USB / Round Pin Socket / Phone Holder	8
Fan Isolator Switch / 10AX Switches / Dimmers	9
Fused Spur Units / 20A Switches / Cooker Switches and Sockets	10
Media Outlets / Blanking Plates / Modular Frames / Pattress Boxes / Screws	11
Connectors / Cable Gland	137

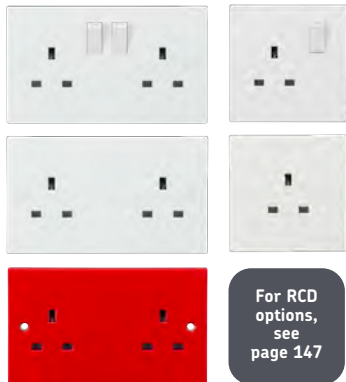

For RCD options, see page 147

13A SOCKETS

- Minimum mounting box depth: 25mm

Code	Size	Model
SN9000	2G	Double Pole + Twin Earth
SN9000S	2G	Single Pole + Twin Earth
SN9000U	2G	Unswitched + Twin Earth
SN9KW	2G	Smart Wi-Fi + Twin Earth for more details see page 164
SN7000	1G	Double Pole
SN7000S	1G	Single Pole
SN7000U	1G	Unswitched
SN9000UR	2G	Unswitched (Red) + Twin Earth NEW



DUAL VOLTAGE SHAVER SOCKET

- Minimum mounting box depth: 47mm

Code	Model
SN8900N	115/230V 20VA Rated + Neon

FLIP-DOWN PHONE HOLDER

- Flip-down phone holder for use with double switched sockets with USB charging facility
- Two-piece install - no need to remove socket from wall
- Sits behind the existing double switched socket
- Fold down shelf for supporting your device whilst charging - folds up when not in use

Code	Size	Model
2GPHW	2G	White



SOCKETS WITH USB

- Minimum mounting box depth: 25-35mm (dependent on wiring conditions)

Code	Size	Model
SN9904	2G	Switched Socket with Dual USB Charger + Twin Earth
SN9903	1G	Switched Socket with USB Charger



ROUND PIN SOCKET

- Minimum mounting box depth: 25mm
- 5A rated

Code	Model
SN5U	Unswitched



10AX FAN ISOLATOR SWITCH

- Minimum mounting box depth: 16mm

Code	Model
SN1100	Triple Pole



10AX SWITCHES

- Minimum mounting box depth: 16mm

Code	Size	Model
SN127		2-Way (Architrave)
SN1200	1G	Intermediate
SN1000	1G	1-Way
SN2000	1G	2-Way
SN3000	2G	2-Way
SN4000	3G	2-Way
SN4100	4G	2-Way
SN4200	6G	2-Way



LEADING-EDGE DIMMERS

- 40-400W incandescent
- 3-100W LED (unless otherwise stated)
- Minimum mounting box depth: 35mm

Code	Size	Model
SN2161	1G	2-Way
SN2165	1G	60-1000W
SN2162	2G	2-Way
SN2163	3G	2-Way
SN2164	4G	2-Way
SN1DIM	1G	Plate and cap only
SN2DIM	2G	Plate and caps only
SN400M		40-400W (3-100W LED) Leading-Edge Module

VFR200M	10-200W (5-150W LED) Trailing-Edge Module
---------	--

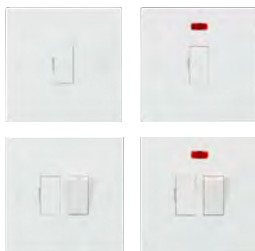

FUSED SPUR UNITS

- Double pole switches (where applicable)
- Minimum mounting box depth: 25mm
- Flex outlet from base

Code	Model
SN6000	Unswitched
SN6000-3A	Unswitched (3A rated)
SN6000N	Unswitched + Neon
SN6300	Switched
SN6300N	Switched + Neon



20A SWITCHES

- Double pole switches (where applicable)
- Minimum mounting box depth: 25mm

Code	Model
SN8341	Switched
SN8341N	Switched + Neon
SN8342	Flex Outlet Plate (from base or centre)



45A COOKER SWITCHES

- Double pole switches
- Minimum mounting box depth: 47mm

Code	Size	Model
SN8331	Single	Switched
SN8331N	Single	Switched + Neon
SN8331W	Single	Switched (White Rocker) NEW
SN8331NW	Single	Switched + Neon (White Rocker) NEW
SN8340	Single	Cooker Connection Unit
SN8332	Double	Switched
SN8332N	Double	Switched + Neon
SN8332W	Double	Switched (White Rocker) NEW
SN8332NW	Double	Switched + Neon (White Rocker) NEW

45A COOKER SWITCH AND SOCKET

- Double pole switch
- 13A switched socket
- Minimum mounting box depth: 47mm

Code	Model
SN8333	Switched
SN8333N	Switched + Neon
SN8333W	Switched (White Rocker) NEW
SN8333NW	Switched + Neon (White Rocker) NEW



MEDIA OUTLETS

- Minimum mounting box depth: 25mm

Code	Model
SN7300	Telephone Socket - Master
SN7400	Telephone Socket - Extension
SN0100	Single TV Outlet - Non-isolated
SN0110	Twin TV Outlet - Non-isolated
SN0120	Single TV Outlet - Isolated
SN0140	TV and SAT TV Outlet - Non-isolated



PATRESS BOXES

Code	Size	Model	Qty
SN1300	Single	16mm + Earth Terminal	10
SN1400	Single	25mm	10
SN1700	Single	35mm + Earth Terminal	10
SN1610	Single	47mm + Earth Terminal and Cable Clamp	10
SN127P		16mm + Earth Terminal (Architrave)	10
SN1500	Double	25mm	5
SN1600	Double	47mm + Earth Terminal and Cable Clamp	5
SN1800	Double	35mm + Earth Terminal	5
SN1510	Double	35mm Dual + Earth Terminals	5



BLANKING PLATES

Code	Model
SN8350	1G
SN8360	2G

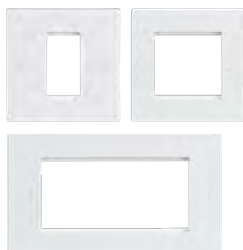

MODULAR FRAMES

- For use with 25mm x 50mm or 50mm x 50mm euro modules

Code	Model
NET1GWH	1 Module
NET2GWH	1 - 2 Modules
NET4GWH	2 - 4 Modules

Modular Inserts available on Page 122-125



ELECTRICAL SCREWS

- M3.5 - Raised head - countersunk

Code	Model	Qty
CSCREW35	35mm	100
CSCREW50	50mm	100
CSCREW75	75mm	100



Single Plate Size:

86mm x 86mm

Double Plate Size:

86mm x 146mm

Plate Thickness:

7mm (unless otherwise stated)



MOULDED SWITCHES & SOCKETS CURVED EDGE

White moulded switches and sockets with gently contoured 7mm plates and soft rounded edges

13A Sockets / Sockets with USB / Phone Holder	14
Media Plate / Shaver Sockets / Round pin Sockets	15
Fan Isolator Switch / 10AX Switches / Dimmers / Fused Spur Units	16
Cooker Switches and Sockets / 20A Switches	17
Media Outlets / Blanking Plates / Modular Frames / Pattress Boxes / Screws	18
Grid Wiring Accessories	19-21



2G FLIP-DOWN PHONE HOLDER

- Handy flip-down phone holder for use with double switched sockets with USB charging facility
- Two-piece install - no need to remove socket from wall
- Sits behind the existing double switched socket
- Fold down shelf for supporting your device whilst charging - folds up when not in use

Code	Size	Finish
2GPHW	2G	White

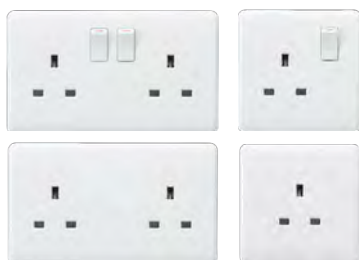

13A SOCKETS

- Minimum mounting box depth: 25mm

Code	Size	Model
CU9000	2G	Double Pole + Twin Earth
CU9000S	2G	Single Pole + Twin Earth
CU9000U	2G	Unswitched + Twin Earth
CU7000	1G	Double Pole
CU7000S	1G	Single Pole
CU7000U	1G	Unswitched



13A SWITCHED SOCKETS WITH USB CHARGER

- Minimum mounting box depth: 25mm - 35mm (dependent on wiring conditions)

Code	Size	Model	USB Config
CU9904	2G	SP Switched Socket	2 x Type-A
CU9931C	2G	SP Switched Socket	Type-A / Type-C NEW
CU9948	2G	DP Switched Socket	2 x Type-A NEW
CU9903	1G	SP Switched Socket	1 x Type-A

CU9931C / CU9948

ARRIVING
Q4 2020



13A MULTIMEDIA COMBINATION PLATE

Essential for any major upgrade, renovation, or new build. The Curved Edge Multimedia Combination Plate allows for a power and bespoke signal distribution solution to be combined in one area. Compatible with our extensive range of modular inserts, this plate can be configured to suit your requirements, be it Satellite, TV, DAB, Telecoms, Networking, or even USB Charging.

- Double pole switches
- 2 x 2G double sockets with twin earth
- Space for up to 8 x euro module inserts (25mm x 50mm)
- Dimensions: (h) 175mm x (w) 295mm x (p) 7mm
- Minimum mounting box depth: 47mm (order **GSK298MM** on page 142)



Modular Inserts available on pages 122-125

Code	Model
CU298MM	Media Plate

NEW

ARRIVING Q4 2020

*Modular inserts not included



DUAL VOLTAGE SHAVER SOCKET

- Minimum mounting box depth: 47mm

Code	Model
CU8900N	20VA 115/230V + Neon



ROUND PIN SOCKET

- 5A rated
- Minimum mounting box depth: 25mm

Code	Model
CU5U	Unswitched



10AX FAN ISOLATOR SWITCH

- Minimum mounting box depth: 16mm

Code	Model
CU1100	Triple Pole



CU1200M - can be attached to any Curved Edge switch plate to make an intermediate switch*



10AX SWITCHES

- Minimum mounting box depth: 16mm (unless otherwise specified)

Code	Size	Model
CU1200	1G	Intermediate
CU1200M		Intermediate Module
CU1000	1G	1-Way
CU2000	1G	2-Way
CU3000	2G	2-Way
CU4000	3G	2-Way
CU4101	4G	2-Way (single plate) Min. mounting depth: 25mm
CU4100	4G	2-Way
CU4200	6G	2-Way



LEADING-EDGE DIMMERS

- 40-400W incandescent | 3-100W LED (unless otherwise specified)
- Minimum mounting box depth: 25mm

Code	Size	Model
CU2161	1G	2-Way
CU2162	2G	2-Way
CU1DIM	1G	Plate and cap only
CU2DIM	2G	Plate and cap only
CU2163	3G	2-Way
CU2164	4G	2-Way
SN400M		40-400W (3-100W LED) Leading-Edge Module
VFR200M		10-200W (5-150W LED) Trailing-Edge Module



FUSED SPUR UNITS

- Minimum mounting box depth: 25mm
- 13A rated
- Double pole switches (where applicable)

Code	Model
CU6000	Unswitched
CU6000-3A	Unswitched (3A fused)
CU6000N	Unswitched + Neon
CU6300	Switched
CU6300N	Switched + Neon
CU6300F	Switched + Flex Outlet from base (10mm plate)

*Not suitable for use with CU4101



20A SWITCHES

- Double pole switches (where applicable)
- Minimum mounting box depth: 25mm

Code	Model
CU8341	Switched
CU8341N	Switched + Neon
CU8342	Flex Outlet Plate (from base or centre)

45A COOKER SWITCHES

- Double pole switches
- Minimum mounting box depth: 47mm

Code	Size	Model
CU8331	Single	Switched
CU8331W	Single	Switched (White Rocker) NEW
CU8331N	Single	Switched + Neon
CU8331NW	Single	Switched + Neon (White Rocker) NEW
CU8332	Double	Switched
CU8332W	Double	Switched (White Rocker) NEW
CU8332N	Double	Switched + Neon
CU8332NW	Double	Switched + Neon (White Rocker) NEW
CU8340	Single	Cooker Connection Unit

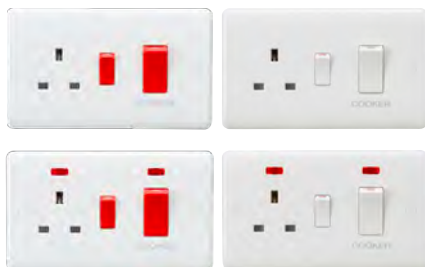

45A COOKER SWITCHES AND SOCKETS

- Double pole switches
- 13A switched socket
- Minimum mounting box depth: 47mm

Code	Model
CU8333	Switched
CU8333W	Switched + Neon (White Rocker) NEW
CU8333N	Switched
CU8333NW	Switched + Neon (White Rocker) NEW



MEDIA OUTLETS

- Minimum mounting box depth: 25mm

Code	Model
CU7300	Telephone Socket - Master
CU7400	Telephone Socket - Extension
CU0100	Single TV Outlet - Non-isolated
CU0110	Twin TV Outlet - Non-isolated
CU0120	Single TV Outlet - Isolated
CU0150	SAT TV Outlet - Non-isolated
CU0140	TV and SAT TV Outlet - Non-isolated



BLANKING PLATES

Code	Model
CU8350	1G
CU8360	2G



MODULAR FRAMES

Code	Model
CU1G	1 Module
CU2G	1 - 2 Modules
CU4G	2 - 4 Modules

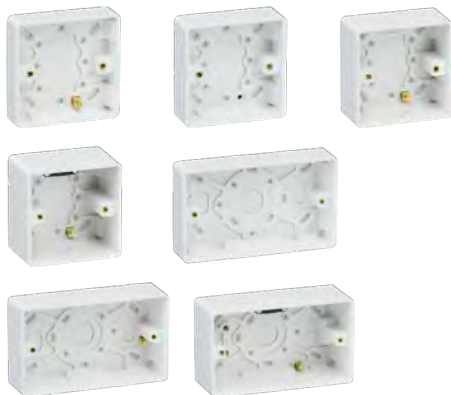

PATTERN BOXES

Code	Size	Model	Qty
CU1300	Single	16mm + Earth Terminal	10
CU1400	Single	25mm	10
CU1700	Single	35mm + Earth Terminal	10
CU1610	Single	47mm + Earth Terminal and Cable Clamp	10
CU1500	Double	25mm	5
CU1800	Double	35mm + Earth Terminal	5
CU1600	Double	47mm + Earth Terminal and Cable Clamp	5



ELECTRICAL SCREWS

- M3.5 - Raised head - countersunk

Code	Model	Qty
CSCREW35	35mm	100
CSCREW50	50mm	100
CSCREW75	75mm	100



Modular Inserts available on pages 122-125

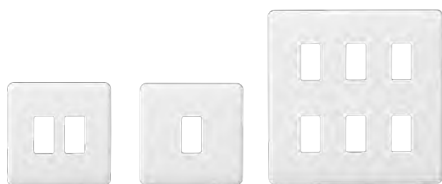

GRID FACEPLATES

- Requires grid mounting frame (sold separately)
- For use with Curved Grid Accessories only

Code	Model
CUG1	1G
CUG2	2G
CUG3	3G
CUG4	4G
CUG6	6G
CUG8	8G
CUG12	12G



GRID MOUNTING FRAMES

Code	Model
CUG1F	1-2G
CUG2F	3-4G



**GRID BACK
BOXES**
can be found
on page 142



20AX GRID KEY SWITCH MODULES

- Supplied with test key

Code	Model
CUGM7	2-Way SP
CUGM8	DP
CUGM9	2-Way SP (marked "EMG LTG TEST")
CUGM10	DP (marked "EMG LTG TEST")
GDKEY	Spare Key



20AX GRID SWITCH MODULES

Code	Model
CUGM1	1-Way SP
CUGM2	2-Way SP
CUGM3	2-Way SP (centre-off)
CUGM4	Intermediate
CUGM5	2-Way SP Retractive (marked "PRESS")
CUGM6	DP



LEADING-EDGE GRID 2-WAY DIMMER

- 40-400W incandescent | 5-100W LED
- Operation: Press on/off - Rotary action dim up/down

Code	Model
CUGM14	40-400W (5-100W LED) Leading-Edge Dimmer



**2G
INTERMEDIATE
SWITCHES**
can be made
using CUGM4



MISCELLANEOUS GRID MODULES

Code	Model
CUGM15	Fuse Holder (13A)
CUGM16	Flex Outlet (max. 10mm)
CUGM17	Blank
CUGM13	Indicator - Red
CUGM12	Indicator - Orange
CUGM11	Indicator - Green



GRID ROCKER COVERS

- Replace an existing rocker with a laser printed version indicating the appliance it refers to

Code	Model
CUDISH	Dishwasher
CUFAN	Fan
CUWASH	Washing Machine
CUDRY	Tumble Dryer
CUHOOD	Cooker Hood
CUHOB	Hob
CUOVEN	Oven
CUMICRO	Microwave
CUFRID	Fridge Freezer
CUBOIL	Boiler





RAISED EDGE SWITCHES AND SOCKETS

DOUBLE POLE SWITCHES

On selected products, for additional safety

LONGLASTING

Robust full metal housing

UNIQUE SOCKET DESIGN

Socket hidden by plug once inserted

COLOUR MATCHING

Matching metal rockers with no surround



QUALITY USB

High quality US IC's and USB controllers on USB products

MOISTURE TRANSFER RESISTANT

Integrated moisture gasket – barely visible when installed



HIGH INTEGRITY EARTHING

Twin earthing terminals (on double switched sockets), for compliance with BS 7671:2008 regulation 543-7

15



YEAR WARRANTY*

*2 YEARS ON ELECTRONIC PRODUCTS

ALL DETAILS ON THIS PAGE REFER TO THE SQUARE AND ROUNDED RAISED EDGE SWITCHES AND SOCKETS



FINISHES

-  BRUSHED CHROME
-  POLISHED CHROME

INSERT OPTIONS

- BLACK
- WHITE
- GREY



RAISED EDGE SWITCHES & SOCKETS ROUNDED EDGE

Metal decorative switches and sockets with a contemporary rounded edge design

13A Sockets / Sockets with USB / Phone Holder	26-27
Shaver Sockets	27
Round Pin Sockets / 10AX Switches / Fan Isolator Switches	28
10AX Toggle Switches	29
Dimmers	30
Fused Spur Units / 20A Switches	31
Cooker Switches and Sockets	32
Media Outlets	32-33
Blanking Plates / Modular Frames Screws	33
Screws	34
Grid Wiring Accessories	34-36



13A SWITCHED SOCKETS

- Double pole switches
- Minimum mounting box depth: 25mm

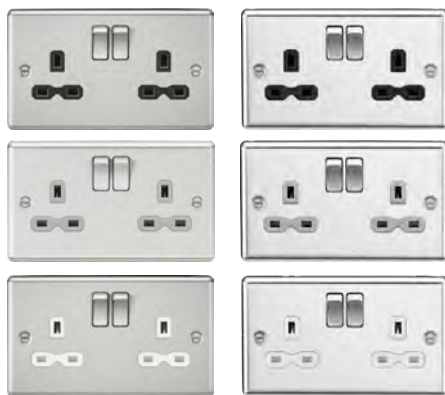

Code	Size	Finish	Insert
CL9BC	2G	Brushed Chrome	Black
CL9BCG	2G	Brushed Chrome	Grey
CL9BCW	2G	Brushed Chrome	White
CL9PC	2G	Polished Chrome	Black NEW
CL9PCG	2G	Polished Chrome	Grey NEW
CL9PCW	2G	Polished Chrome	White NEW

13A SWITCHED SOCKET WITH DUAL USB CHARGER

- Minimum mounting box depth: 25mm-35mm (dependent on wiring conditions)



Code	Size	Finish	Insert
CL9224BC	2G	Brushed Chrome	Black
CL9224BCG	2G	Brushed Chrome	Grey
CL9224BCW	2G	Brushed Chrome	White
CL9224PC	2G	Polished Chrome	Black NEW
CL9224PCG	2G	Polished Chrome	Grey NEW
CL9224PCW	2G	Polished Chrome	White NEW



Code	Size	Finish	Insert
CL7BC	1G	Brushed Chrome	Black
CL7BCG	1G	Brushed Chrome	Grey
CL7BCW	1G	Brushed Chrome	White
CL7PC	1G	Polished Chrome	Black NEW
CL7PCG	1G	Polished Chrome	Grey NEW
CL7PCW	1G	Polished Chrome	White NEW

FLIP-DOWN PHONE HOLDER

- Handy flip-down phone holder for use with double switched sockets with USB charging facility
- Two-piece install - no need to remove socket from wall
- Sits behind the existing double switched socket
- Fold down shelf for supporting your device whilst charging - folds up when not in use



Code	Finish
2GPHBK	Black
2GPHGY	Grey
2GPHW	White

13A SWITCHED SOCKET WITH DUAL USB CHARGER

- Minimum mounting box depth: 25mm-35mm (dependent on wiring conditions)



Code	Size	Finish	Insert	
CL91BC	1G	Brushed Chrome	Black	
CL91BCG	1G	Brushed Chrome	Grey	
CL91BCW	1G	Brushed Chrome	White	
CL91PC	1G	Polished Chrome	Black	NEW
CL91PCG	1G	Polished Chrome	Grey	NEW
CL91PCW	1G	Polished Chrome	White	NEW

DUAL VOLTAGE SHAVER SOCKETS

- IP41 rated
- 115/230V 20VA rated
- Minimum mounting box depth: 47mm



Code	Finish	Insert	
CL89BC	Brushed Chrome	Black	
CL89BCG	Brushed Chrome	Grey	
CL89BCW	Brushed Chrome	White	
CL89PC	Polished Chrome	Black	NEW
CL89PCG	Polished Chrome	Grey	NEW
CL89PCW	Polished Chrome	White	NEW





ROUND PIN SOCKETS

- 5A rated
- Minimum mounting box depth: 25mm



Code	Finish	Insert	
CL5ABC	Brushed Chrome	Black	
CL5ABCG	Brushed Chrome	Grey	
CL5ABCW	Brushed Chrome	White	
CL5APC	Polished Chrome	Black	NEW
CL5APCG	Polished Chrome	Grey	NEW
CL5APCW	Polished Chrome	White	NEW

10AX FAN ISOLATOR SWITCHES

- Minimum mounting box depth: 16mm
- Triple pole



Code	Finish	
CL11BC	Brushed Chrome	
CL11PC	Polished Chrome	NEW

GRID FAN
ISOLATOR
MODULES
PAGE 35



10AX SWITCHES

- Minimum mounting box depth: 16mm



Code	Size	Model	Finish	
CL12BC	1G	Intermediate	Brushed Chrome	
CL12PC	1G	Intermediate	Polished Chrome	NEW
CL2BC	1G	2-Way	Brushed Chrome	
CL2PC	1G	2-Way	Polished Chrome	NEW



Code	Size	Model	Finish	
CL3BC	2G	2-Way	Brushed Chrome	
CL3PC	2G	2-Way	Polished Chrome	NEW



Code	Size	Model	Finish	
CL4BC	3G	2-Way	Brushed Chrome	
CL4PC	3G	2-Way	Polished Chrome	NEW



Code	Size	Model	Finish	
CL41BC	4G	2-Way	Brushed Chrome	
CL41PC	4G	2-Way	Polished Chrome	NEW



Code	Size	Model	Finish	
CL42BC	6G	2-Way	Brushed Chrome	
CL42PC	6G	2-Way	Polished Chrome	NEW

10AX TOGGLE SWITCHES

- Minimum mounting box depth: 16mm



Code	Size	Model	Finish
CLTOG12BC	1G	Intermediate	Brushed Chrome
CLTOG12PC	1G	Intermediate	Polished Chrome NEW
CLTOG1BC	1G	2-Way	Brushed Chrome
CLTOG1PC	1G	2-Way	Polished Chrome NEW

Code	Size	Model	Finish
CLTOG3BC	3G	2-Way	Brushed Chrome
CLTOG3PC	3G	2-Way	Polished Chrome NEW



Code	Size	Model	Finish
CLTOG2BC	2G	2-Way	Brushed Chrome
CLTOG2PC	2G	2-Way	Polished Chrome NEW

Code	Size	Model	Finish
CLTOG4BC	4G	2-Way	Brushed Chrome
CLTOG4PC	4G	2-Way	Polished Chrome NEW





TRAILING EDGE DIMMERS

- 10-200W incandescent | 5-150W LED
- Minimum mounting box depth: 25mm



Code	Size	Model	Finish
CL2181BC	1G	2-Way	Brushed Chrome
CL2181PC	1G	2-Way	Polished Chrome NEW



Code	Size	Model	Finish
CL2183BC	3G	2-Way	Brushed Chrome
CL2183PC	3G	2-Way	Polished Chrome NEW



Code	Size	Model	Finish
CL2182BC	2G	2-Way	Brushed Chrome
CL2182PC	2G	2-Way	Polished Chrome NEW



Code	Size	Model	Finish
CL2184BC	4G	2-Way	Brushed Chrome
CL2184PC	4G	2-Way	Polished Chrome NEW



FUSED SPUR UNITS

- 13A rated
- Double pole switches where applicable
- Minimum Mounting Box Depth: 25mm



Code	Model	Finish
CL6BC	Unswitched	Brushed Chrome
CL6PC	Unswitched	Polished Chrome NEW

20A SWITCHES

- Double pole switches
- Minimum mounting box depth: 25mm



Code	Model	Finish
CL834BC	Switched	Brushed Chrome
CL834PC	Switched	Polished Chrome NEW



Code	Model	Finish
CL63BC	Switched	Brushed Chrome
CL63PC	Switched	Polished Chrome NEW



Code	Model	Finish
CL834NBC	Switched + Neon	Brushed Chrome
CL834NPC	Switched + Neon	Polished Chrome NEW



Code	Model	Finish
CL63NBC	Switched + Neon	Brushed Chrome
CL63NPC	Switched + Neon	Polished Chrome NEW



Code	Model	Finish
CL834FBC	Switched + Neon + Flex Outlet (front)	Brushed Chrome
CL834FPC	Switched + Neon + Flex Outlet (front)	Polished Chrome NEW



Code	Model	Finish
CL63FBC	Switched + Neon + Flex Outlet (front)	Brushed Chrome
CL63FPC	Switched + Neon + Flex Outlet (front)	Polished Chrome NEW



45A COOKER SWITCHES

- Double pole switches
- Neon indicator
- Minimum mounting box depth: 47mm



Code	Size	Finish
CL81NBC	Single	Brushed Chrome
CL81NPC	Single	Polished Chrome NEW



Code	Size	Finish
CL82NBC	Double	Brushed Chrome
CL82NPC	Double	Polished Chrome NEW

45A COOKER SWITCH AND SOCKET WITH NEONS

- Double pole switches • 13A Switched socket
- Minimum mounting box depth: 47mm

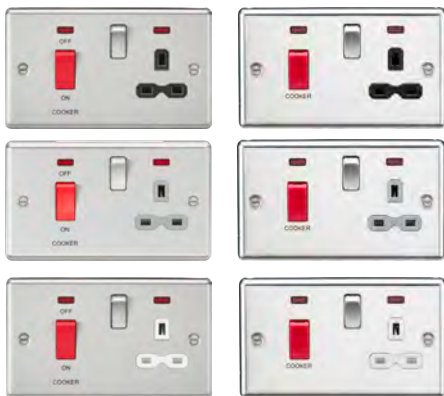

Code	Finish	Insert
CL83BC	Brushed Chrome	Black
CL83BCG	Brushed Chrome	Grey
CL83BCW	Brushed Chrome	White
CL83PC	Polished Chrome	Black
CL83PCG	Polished Chrome	Grey
CL83PCW	Polished Chrome	White

TELEPHONE SOCKETS

- Minimum mounting box depth: 25mm



Code	Model	Finish
CL73BC	Master	Brushed Chrome
CL73PC	Master	Polished Chrome NEW
CL74BC	Extension	Brushed Chrome
CL74PC	Extension	Polished Chrome NEW

NETWORK OUTLETS

- Minimum mounting box depth: 25mm



Code	Model	Finish
CL45BC	RJ45	Brushed Chrome
CL45PC	RJ45	Polished Chrome NEW

TV OUTLET

- Minimum mounting box depth: 25mm



Code	Model	Finish
CL010BC	Non-isolated	Brushed Chrome
CL010PC	Non-isolated	Polished Chrome NEW

SAT TV OUTLET

- Minimum mounting box depth: 25mm



Code	Model	Finish
CL015BC	Non-isolated	Brushed Chrome
CL015PC	Non-isolated	Polished Chrome NEW

MODULAR FRAMES

- For use with 25mm x 50mm and/or 50mm x 50mm euro modules



Code	Model	Finish
CL16BC	1 Module	Brushed Chrome
CL16PC	1 Module	Polished Chrome NEW

TV AND SAT TV OUTLET

- Minimum mounting box depth: 25mm



Code	Model	Finish
CL014BC	Isolated	Brushed Chrome
CL014PC	Isolated	Polished Chrome NEW



Code	Model	Finish
CL26BC	1-2 Modules	Brushed Chrome
CL26PC	1-2 Modules	Polished Chrome NEW

BLANKING PLATES



Code	Size	Finish
CL85BC	1G	Brushed Chrome
CL85PC	1G	Polished Chrome NEW



Code	Size	Finish
CL86BC	2G	Brushed Chrome
CL86PC	2G	Polished Chrome NEW



Code	Model	Finish
CL46BC	2-4 Modules	Brushed Chrome
CL46PC	2-4 Modules	Polished Chrome NEW



MODULAR
INSERTS
AVAILABLE
PAGES
122-125



NEW POLISHED CHROME

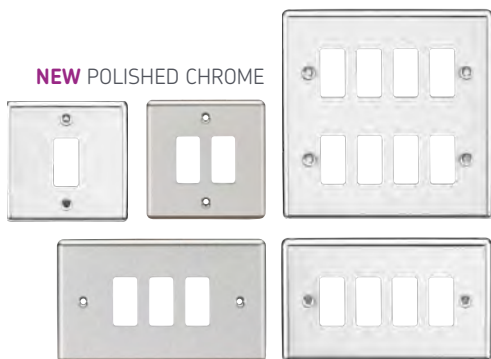

GRID
BACK
BOXES
PAGE 142



GRID FACEPLATES

- Requires grid mounting frame (sold separately)
- For use with Knightsbridge Grid Accessories only

To indicate preferred finish, replace xx on code with BC (Brushed Chrome) or PC (Polished Chrome)

Code	Size
GDCL1xx	1G
GDCL2xx	2G
GDCL3xx	3G
GDCL4xx	4G
GDCL6xx	6G
GDCL8xx	8G
GDCL9xx	9G (Brushed Chrome only)
GDCL12xx	12G (Brushed Chrome only)

ELECTRICAL SCREWS

- M3.5 - Raised head - countersunk

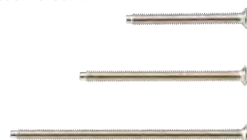

Code	Screw Length	Qty
CSCREW35	35mm	100
CSCREW50	50mm	100
CSCREW75	75mm	100

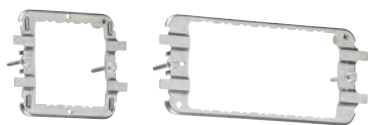

GRID MOUNTING FRAMES

Code	Size
GDF001F	1-2G
GDF002F	3-4G



20AX GRID SWITCH MODULES

Code	Model
GDM001xx	2-Way SP
GDM002xx	DP
GDM003xx	DP + LED Indicator
GDM00xx	2-Way SP (centre off)
GDM005xx	Intermediate
GDM006xx	2-Way SP Retractive (marked "PRESS")



GRID TRAILING-EDGE DIMMER MODULES

- 10-200W incandescent | 10-100W LED

Code	Model
GDM014xx	Trailing-Edge Dimmer (Press)
GDM200xx	Trailing-Edge Dimmer (Rotary) NEW



10A GRID FAN ISOLATOR MODULES

- Triple pole
- Requires single grid position only

Code	Model
GDM020xx	Fan Isolator Switch Module NEW
GDM021xx	Fan Isolator Key Switch Module (supplied with test key) NEW



GRID DUAL USB CHARGER MODULE

- Requires two grid positions

Code	Model
GDM016xx	Grid Dual USB Charger Module





20AX GRID KEY SWITCH MODULES

- Supplied with test key

Code	Model
GDM007xx	2-Way SP (marked "EMG LTG TEST")
GDM008xx	DP (marked "EMG LTG TEST")
GDM009xx	2-Way SP
GDM010xx	DP
GDKEY	Spare Key



MISCELLANEOUS GRID MODULES

Code	Model
GDM011xx	Fuse Holder (13A)
GDM012xx	Flex Outlet (max. 10mm)
GDM013xx	Blank
GDM017	Indicator - Green
GDM018	Indicator - Red
GDM019	Indicator - Orange



ENGRAVED ROCKER COVERS



GRID DUMMY DIMMER MODULE

- Push on/off function only
- Ideal for situations where you require one position to look like a dimmer but act like a switch

Code	Model
GDM022xx	6A 2-Way



GRID ROCKER COVERS

- Easy to install
- Replace an existing rocker with an engraved version indicating the appliance it refers to

Code	Model
GDBOILxx	Boiler
GDDISHxx	Dishwasher
GDFANxx	Fan
GDWASHxx	Washing Machine
GDDRYxx	Tumble Dryer
GDCOOKxx	Cooker Hood
GDHOBxx	Hob
GDOVENxx	Oven
GDMICROxx	Microwave
GDFRIDxx	Fridge Freezer



We're only a click away.

K-Direct is a quick and reliable home delivery service that provides next day delivery (across mainland UK) with a no-minimum order value or quantity. Simply place your customer's order online and have it delivered direct on your behalf. Cut out the time spent double handling and order exactly what you want without having to order minimum product quantities. Don't let logistics stand in the way of you and our fantastic products - order with K-Direct and ensure a professional, fast and efficient delivery service.

Our responsive website ensures, however you access our products, your experience is quick and hassle free.

 **direct**
**Quality products,
 first class delivery**

-
- A quick and reliable home delivery service
 - Shipping direct to your customers on **YOUR** behalf
 - In excess of 3000 product lines in stock now
 - Quality which is not compromised, MLA is renowned for a 1st class customer service experience
 - No minimum box quantities*
 - No minimum order value
 - Reduces commitment to stock
 - No double handling
 - Next day delivery across mainland UK
 - Fast, efficient and professional
 - Created for our wholesalers to satisfy their customers

* Exceptions apply to fragile items

Place your customers order online and have it delivered direct on your behalf



FINISHES

 BRUSHED CHROME

 ANTIQUE BRASS

INSERT OPTIONS

BLACK

WHITE

GREY

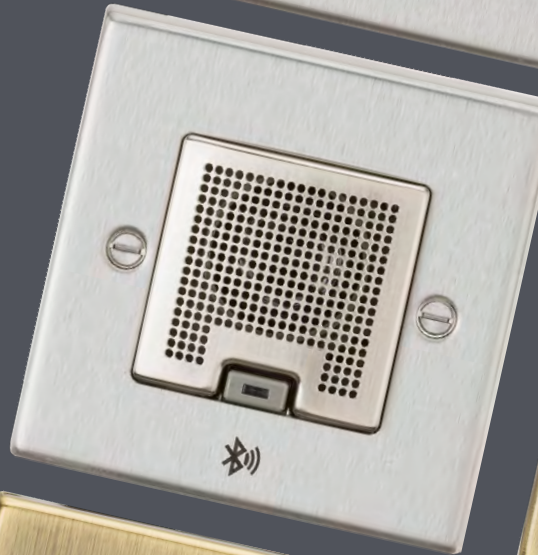
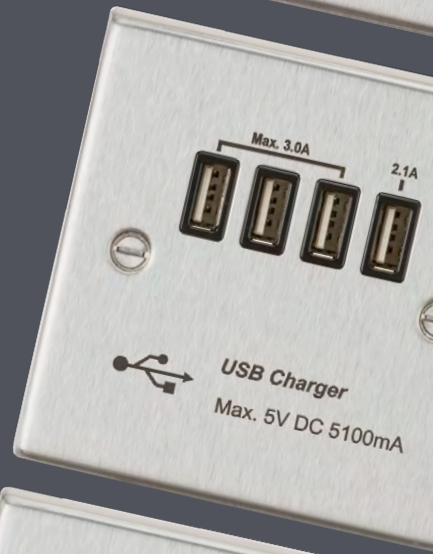

RAISED EDGE SWITCHES & SOCKETS

SQUARE EDGE

A comprehensive range of metal decorative switches and sockets with a square edge design

13A Sockets / Switched Sockets with USB	40
Phone Holder / FASTCHARGE USB Sockets	41
Quad USB Sockets / Bluetooth Speaker Sockets	42
Shaver Sockets / Round Pin Sockets / Fan Isolator Switches	43
10AX Switches	44
10AX Toggle Switches / Dimmers	45
Fused Spur Units / 20A Switches	46
Cooker Switches and Sockets	47
Media Outlets	47-48
Blanking Plates / Modular Frames	48
Grid Wiring Accessories	49-51



13A SOCKETS

- Double pole switches
- Minimum mounting box depth: 25mm



Code	Size	Finish	Insert
CS9BC	2G	Brushed Chrome	Black
CS9BCG	2G	Brushed Chrome	Grey
CS9BCW	2G	Brushed Chrome	White
CS9AB	2G	Antique Brass	Black



Code	Size	Finish	Insert
CS7BC	1G	Brushed Chrome	Black
CS7BCG	1G	Brushed Chrome	Grey
CS7BCW	1G	Brushed Chrome	White
CS7AB	1G	Antique Brass	Black

13A SWITCHED SOCKET WITH DUAL USB CHARGER

- Minimum mounting box depth: 25mm-35mm (dependent on wiring conditions)



Code	Size	Finish	Insert
CS9224BC	2G	Brushed Chrome	Black
CS9224BCG	2G	Brushed Chrome	Grey
CS9224BCW	2G	Brushed Chrome	White
CS9224AB	2G	Antique Brass	Black



Code	Size	Finish	Insert
CS91BC	1G	Brushed Chrome	Black
CS91BCG	1G	Brushed Chrome	Grey
CS91BCW	1G	Brushed Chrome	White
CS91AB	1G	Antique Brass	Black

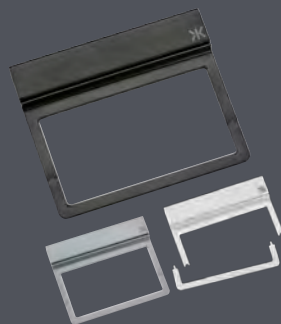

2G FLIP-DOWN PHONE HOLDER

- Two-piece install
- no need to remove socket from wall

Code	Finish
2GPHBK	Black
2GPHGY	Grey
2GPHWH	White

Socket not included



FASTCHARGE

13A 2G SWITCHED SOCKET WITH DUAL USB CHARGER (TYPE-A FASTCHARGE PORT)

- Double pole switches
- FASTCHARGE port: Type-A max. 5V-12V DC 3A
- Standard port: Type-A max. 5V DC 2A
- Total USB charging rate: 5V-12V DC 4A
- Minimum mounting box depth: 25mm-35mm
(dependent on wiring conditions)



Code	Finish	Insert
CS9906BC	Brushed Chrome	Black
CS9906BCG	Brushed Chrome	Grey
CS9906BCW	Brushed Chrome	White

13A 2G SWITCHED SOCKET WITH DUAL USB CHARGER (TYPE-C FASTCHARGE PORT)

- Double pole switches
- FASTCHARGE port: Type-C max. 5V-12V DC 3A
- Standard port: Type-A max. 5V DC 2A
- Total USB charging rate: 5V-12V DC 4A
- Minimum mounting box depth: 25mm-35mm
(dependent on wiring conditions)



Code	Finish	Insert
CS9907BC	Brushed Chrome	Black
CS9907BCG	Brushed Chrome	Grey
CS9907BCW	Brushed Chrome	White



13A SWITCHED SOCKET WITH QUAD USB CHARGER

- USB charging rate: 5V DC 5.1A (shared)
- 3 ports share 3A
- 1 port dedicated 2.1A
- Minimum mounting box depth: 25mm-35mm (dependent on wiring conditions)

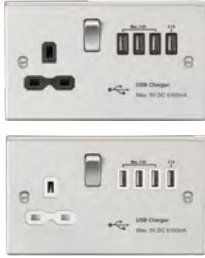

Code	Finish	Insert
CS7USB4BC	Brushed Chrome	Black
CS7USB4BCG	Brushed Chrome	Grey
CS7USB4BCW	Brushed Chrome	White

Code	Finish	Insert
CSQUADBC	Brushed Chrome	Black
CSQUADBCG	Brushed Chrome	Grey
CSQUADBCW	Brushed Chrome	White

13A SWITCHED SOCKET WITH DUAL USB CHARGER AND BLUETOOTH SPEAKER

- 3W RMS bluetooth speaker
- Minimum mounting box depth: 25-35mm (dependent on wiring conditions)



Code	Finish	Insert
CS9905BC	Brushed Chrome	Black
CS9905BCG	Brushed Chrome	Grey
CS9905BCW	Brushed Chrome	White

FLUSH MOUNT BLUETOOTH SPEAKER

- 3W RMS bluetooth speaker
- Minimum mounting box depth: 25mm-35mm (dependent on wiring conditions)



Code	Finish
CSBLUEBC	Brushed Chrome



DUAL VOLTAGE SHAVER SOCKETS

- IP41 rated
- 115/230V 20VA rated
- Minimum mounting box depth: 47mm



Code	Finish	Insert
CS89BC	Brushed Chrome	Black
CS89BCG	Brushed Chrome	Grey
CS89BCW	Brushed Chrome	White
CS89AB	Antique Brass	Black

ROUND PIN SOCKETS

- 5A rated
- Minimum mounting box depth: 25mm



Code	Finish	Insert
CS55ABC	Brushed Chrome	Black
CS55BCG	Brushed Chrome	Grey
CS55BCW	Brushed Chrome	White
CS55AAB	Antique Brass	Black

10AX FAN ISOLATOR SWITCH

- Minimum mounting box depth: 16mm
- Triple pole



Code	Finish
CS11BC	Brushed Chrome
CS11AB	Antique Brass



GRID FAN ISOLATOR MODULES

PAGE 50



10AX SWITCHES

- Minimum mounting box depth: 16mm



Code	Size	Model	Finish
CS12BC	1G	Intermediate	Brushed Chrome
CS12AB	1G	Intermediate	Antique Brass

Code	Size	Model	Finish
CS2BC	1G	2-Way	Brushed Chrome
CS2AB	1G	2-Way	Antique Brass



Code	Size	Model	Finish
CS3BC	2G	2-Way	Brushed Chrome
CS3AB	2G	2-Way	Antique Brass

Code	Size	Model	Finish
CS41BC	4G	2-Way	Brushed Chrome
CS41AB	4G	2-Way	Antique Brass



Code	Size	Model	Finish
CS4BC	3G	2-Way	Brushed Chrome
CS4AB	3G	2-Way	Antique Brass

Code	Size	Model	Finish
CS42BC	6G	2-Way	Brushed Chrome
CS42AB	6G	2-Way	Antique Brass

10AX TOGGLE SWITCHES

- Minimum mounting box depth: 16mm



Code	Size	Model	Finish
CSTOG12BC	1G	Intermediate	Brushed Chrome
CSTOG12AB	1G	Intermediate	Antique Brass
CSTOG1BC	1G	2-Way	Brushed Chrome
CSTOG1AB	1G	2-Way	Antique Brass



Code	Size	Model	Finish
CSTOG2BC	2G	2-Way	Brushed Chrome
CSTOG2AB	2G	2-Way	Antique Brass



Code	Size	Model	Finish
CSTOG3BC	3G	2-Way	Brushed Chrome
CSTOG3AB	3G	2-Way	Antique Brass



Code	Size	Model	Finish
CSTOG4BC	4G	2-Way	Brushed Chrome
CSTOG4AB	4G	2-Way	Antique Brass

TRAILING-EDGE DIMMERS

- 10-200W incandescent | 5-150W LED
- Minimum mounting box depth: 25mm



Code	Size	Model	Finish
CS2181BC	1G	2-Way	Brushed Chrome
CS2181AB	1G	2-Way	Antique Brass



Code	Size	Model	Finish
CS2182BC	2G	2-Way	Brushed Chrome
CS2182AB	2G	2-Way	Antique Brass



Code	Size	Model	Finish
CS2183BC	3G	2-Way	Brushed Chrome
CS2183AB	3G	2-Way	Antique Brass



Code	Size	Model	Finish
CS2184BC	4G	2-Way	Brushed Chrome
CS2184AB	4G	2-Way	Antique Brass





FUSED SPUR UNITS

- 13A rated
- Double pole switches where applicable
- Minimum mounting box depth: 25mm



Code	Model	Finish
CS6BC	Unswitched	Brushed Chrome
CS6AB	Unswitched	Antique Brass



Code	Model	Finish
CS63BC	Switched	Brushed Chrome
CS63AB	Switched	Antique Brass



Code	Model	Finish
CS63NBC	Switched + Neon	Brushed Chrome
CS63NAB	Switched + Neon	Antique Brass



Code	Model	Finish
CS63FBC	Switched + Neon + Flex Outlet (front)	Brushed Chrome
CS63FAB	Switched + Neon + Flex Outlet (front)	Antique Brass

20A SWITCHES

- Double pole switches
- Minimum mounting box depth: 25mm

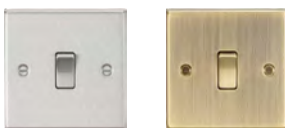

Code	Model	Finish
CS834BC	Switched	Brushed Chrome
CS834AB	Switched	Antique Brass



Code	Model	Finish
CS834NBC	Switched + Neon	Brushed Chrome
CS834NAB	Switched + Neon	Antique Brass



Code	Model	Finish
CS834FBC	Switched + Neon + Flex Outlet (front)	Brushed Chrome
CS834FAB	Switched + Neon + Flex Outlet (front)	Antique Brass

45A COOKER SWITCHES WITH NEONS

- Double pole switches
- Minimum mounting box depth: 47mm



Code	Size	Finish
CS81NBC	Single	Brushed Chrome
CS81NAB	Single	Antique Brass



Code	Size	Finish
CS82NBC	Double	Brushed Chrome
CS82NAB	Double	Antique Brass

45A COOKER SWITCH AND SOCKET WITH NEONS

- Double pole switches
- 13A switched socket
- Minimum mounting box depth: 47mm



Code	Finish	Insert
CS83BC	Brushed Chrome	Black
CS83BCG	Brushed Chrome	Grey
CS83BCW	Brushed Chrome	White
CS83AB	Antique Brass	Black



TELEPHONE SOCKETS

- Minimum mounting box depth: 25mm



Code	Model	Finish
CS73BC	Master	Brushed Chrome
CS73AB	Master	Antique Brass
CS74BC	Extension	Brushed Chrome
CS74AB	Extension	Antique Brass

NETWORK OUTLETS

- Minimum mounting box depth: 25mm



Code	Model	Finish
CS45BC	RJ45	Brushed Chrome
CS45AB	RJ45	Antique Brass

TV OUTLET

- Minimum mounting box depth: 25mm



Code	Model	Finish
CS010BC	Non-isolated	Brushed Chrome
CS010AB	Non-isolated	Antique Brass

45A SWITCH AND SOCKET WITH DUAL USB CHARGER

- Double pole switches
- 13A switched socket
- Minimum mounting box depth: 47mm



Code	Model	Insert
CS8333UBC	Switched + Dual USB	Black
CS8333UBCG	Switched + Dual USB	Grey
CS8333UBCW	Switched + Dual USB	White



SAT TV OUTLET

- Minimum mountingbox depth: 25mm



Code	Model	Finish
CS015BC	Non-isolated	Brushed Chrome
CS015AB	Non-isolated	Antique Brass

MODULAR FRAMES

- For use with 25mm x 50mm and/or 50mm x 50mm euro modules



Code	Model	Finish
CS1GBC	1 Module	Brushed Chrome
CS1GAB	1 Module	Antique Brass

TV AND SAT TV OUTLET

- Minimum mounting box depth: 25mm



Code	Model	Finish
CS014BC	Isolated	Brushed Chrome
CS014AB	Isolated	Antique Brass



Code	Model	Finish
CS2GBC	1-2 Modules	Brushed Chrome
CS2GAB	1-2 Modules	Antique Brass

BLANKING PLATES



Code	Size	Finish
CS85BC	1G	Brushed Chrome
CS85AB	1G	Antique Brass



Code	Model	Finish
CS4GBC	2-4 Modules	Brushed Chrome
CS4GAB	2-4 Modules	Antique Brass



Code	Size	Finish
CS86BC	2G	Brushed Chrome
CS86AB	2G	Antique Brass



MODULAR
INSERTS
AVAILABLE

**ON PAGES
122-125**



GRID FACEPLATES

- Requires grid mounting frame (sold separately)
- For use with Knightsbridge Grid accessories only

Code	Size
GDCS1BC	1G
GDCS2BC	2G
GDCS3BC	3G
GDCS4BC	4G
GDCS6BC	6G
GDCS8BC	8G
GDCS9BC	9G
GDCS12BC	12G

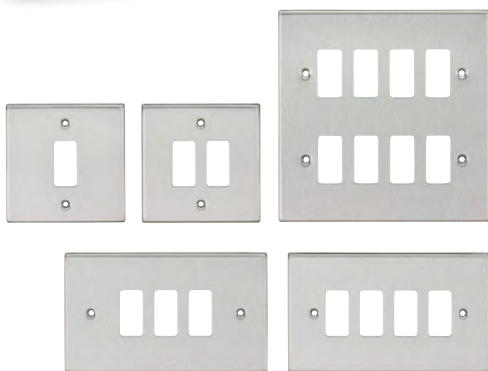

GRID MOUNTING FRAMES



Code	Size
GDF001F	1-2G
GDF002F	3-4G

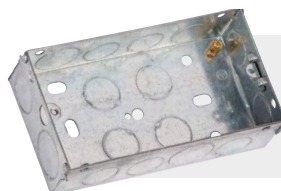

GRID
BACK BOXES

PAGE 142



20AX GRID SWITCH MODULES

Code	Model
GDM001BC	2-Way SP
GDM002BC	DP
GDM003BC	DP + LED Indicator
GDM004BC	2-Way SP (centre-off)
GDM005BC	Intermediate
GDM006BC	2-Way SP Retractive (marked "PRESS")

2G INTERMEDIATE SWITCHES

can be made using GDM005BC



10A GRID FAN ISOLATOR MODULES

- Triple pole
- Requires single grid position only

Code	Model
GDM020BC	Fan Isolator Switch Module
GDM021BC	Fan Isolator Key Switch Module (supplied with test key)



20AX GRID KEY SWITCH MODULES

- Supplied with test key

Code	Model
GDM007BC	2-Way SP (marked "EMG LTG TEST")
GDM008BC	DP (marked "EMG LTG TEST")
GDM009BC	2-Way SP
GDM010BC	DP
GDKEY	Spare Key



GRID TRAILING-EDGE DIMMER MODULES

- 10-200W incandescent | 10-100W LED

Code	Model
GDM014BC	Trailing-Edge Dimmer (Press)
GDM200BC	Trailing-Edge Dimmer (Rotary)



GRID DUMMY DIMMER MODULE

- Push on/off function only
- Ideal for situations where you require one position to look like a dimmer but act like a switch

Code	Model	
GDM022BC	6A 2-Way	NEW



MISCELLANEOUS GRID MODULES

Code	Model
GDM011BC	Fuse Holder (13A)
GDM012BC	Flex Outlet (max. 10mm)
GDM013BC	Blank
GDM017	Indicator - Green
GDM018	Indicator - Red
GDM019	Indicator - Orange



GRID DUAL USB CHARGER MODULE

- Requires two grid positions



Code	Model
GDM016BC	Dual USB Charger Module



GRID ROCKER COVERS

- Easy to install
- Replace an existing rocker with an engraved version indicating the appliance it refers to

Code	Model
GDBOILBC	Boiler
GDDISHBC	Dishwasher
GDFANBC	Fan
GDWASHBC	Washing Machine
GDDRYBC	Tumble Dryer
GDCOOKBC	Cooker Hood
GDHOBBC	Hob
GDOVENBC	Oven
GDMICROBC	Microwave
GDFRIDBC	Fridge Freezer



ENGRAVED ROCKER COVERS



FINISHES

 BRUSHED CHROME

 POLISHED CHROME

 POLISHED BRASS

 BRUSHED BRASS

 GUNMETAL

 PEARL

INSERT OPTIONS

BLACK

WHITE

GREY



FLAT PLATE

Metal decorative switches and sockets featuring an ultra slim profile design

13A Switched Sockets	56
Floor Sockets	57
Sockets with USB	57-58
Quad USB Sockets	59-60
Bluetooth Speaker Sockets	60
Phone Holder / Shaver Sockets	61
Round Pin Sockets / Fan isolator Switches	62
10AX Switches	62-63
10AX Toggle Switches	64
Dimmers	65
Fused Spur Units	66
20A Switches	67
Cooker Switches and Sockets	68
Media Outlets / Blanking Plates	69-70
Modular Frames	71
Grid Wiring Accessories	72-74



LONGLASTING

Robust full metal housing

COLOUR MATCHING

Matching metal rockers with no surround

DOUBLE POLE SWITCHES

On selected products, for additional safety

Single Plate Size:
87.5mm x
87.5mm

Double Plate Size:
87.5mm x
147.5mm

Plate Projection:
2.5mm

UNIQUE SOCKET DESIGN

Socket concealed by plug once inserted

LOW PROFILE DESIGN

Plate Projection
2.5mm
(including gasket)



MOISTURE TRANSFER RESISTANT

Integrated moisture gasket - barely visible when installed

HIGH INTEGRITY EARTHING

Twin earthing terminals (on double switched sockets), for compliance with BS 7671:2008 regulation 543-7

High quality US IC's, and USB controllers



15

YEAR WARRANTY*

*2 YEARS ON ELECTRONIC PRODUCTS





13A DP SWITCHED SOCKETS

- Twin earth
- Double pole switches
- Minimum mounting box depth: 25mm



Code	Size	Finish	Insert
FPR9000BC	2G	Brushed Chrome	Black
FPR9000BCG	2G	Brushed Chrome	Grey
FPR9000BCW	2G	Brushed Chrome	White
FPR9000GM	2G	Gunmetal	Black
FPR9000PB	2G	Polished Brass	Black

Code	Size	Finish	Insert
FPR9000PLW	2G	Pearl	White
FPR9000BB	2G	Brushed Brass	Black
FPR9000PC	2G	Polished Chrome	Black
FPR9000PCG	2G	Polished Chrome	Grey
FPR9000PCW	2G	Polished Chrome	White



Code	Size	Finish	Insert
FPR7000BC	1G	Brushed Chrome	Black
FPR7000BCG	1G	Brushed Chrome	Grey
FPR7000BCW	1G	Brushed Chrome	White
FPR7000GM	1G	Gunmetal	Black
FPR7000PB	1G	Polished Brass	Black

Code	Size	Finish	Insert
FPR7000PLW	1G	Pearl	White
FPR7000BB	1G	Brushed Brass	Black
FPR7000PC	1G	Polished Chrome	Black
FPR7000PCG	1G	Polished Chrome	Grey
FPR7000PCW	1G	Polished Chrome	White

FLOOR SOCKETS

- 13A rated
- Unswitched
- Spring-loaded cover
- Minimum recessed depth: 35mm
- 1G: 94.5mm x 86mm
- 2G: 94.5mm x 144mm



Code	Size	Finish	Insert
FPR7UPBW	1G	Polished Brass	White
FPR7UPCW	1G	Polished Chrome	White
FPR7UBBW	1G	Brushed Brass	White
FPR7UBCW	1G	Brushed Chrome	White

Code	Size	Finish	Insert
FPR9UPBW	2G	Polished Brass	White
FPR9UPCW	2G	Polished Chrome	White
FPR9UBBW	2G	Brushed Brass	White
FPR9UBCW	2G	Brushed Chrome	White

13A 2G SWITCHED SOCKET WITH DUAL USB CHARGER

- Twin earth
- Minimum mounting box depth: 25mm-35mm (dependent on wiring conditions)



Code	Size	Finish	Insert
FPR9224BC	2G	Brushed Chrome	Black
FPR9224BCG	2G	Brushed Chrome	Grey
FPR9224BCW	2G	Brushed Chrome	White
FPR9224GM	2G	Gunmetal	Black
FPR9224PB	2G	Polished Brass	Black

Code	Size	Finish	Insert
FPR9224PLW	2G	Pearl	White
FPR9224BB	2G	Brushed Brass	Black
FPR9224PC	2G	Polished Chrome	Black
FPR9224PCG	2G	Polished Chrome	Grey
FPR9224PCW	2G	Polished Chrome	White



13A 1G SWITCHED SOCKET WITH DUAL USB CHARGER

- Minimum Mounting box depth: 25mm-35mm (dependent on wiring conditions)



Code	Size	Finish	Insert
FPR9901BC	1G	Brushed Chrome	Black
FPR9901BCG	1G	Brushed Chrome	Grey
FPR9901BCW	1G	Brushed Chrome	White
FPR9901GM	1G	Gunmetal	Black
FPR9901PB	1G	Polished Brass	Black

Code	Size	Finish	Insert
FPR9901PLW	1G	Pearl	White
FPR9901BB	1G	Brushed Brass	Black
FPR9901PC	1G	Polished Chrome	Black
FPR9901PCG	1G	Polished Chrome	Grey
FPR9901PCW	1G	Polished Chrome	White

INNOVATIONS

13A 2G SWITCHED SOCKET WITH DUAL USB CHARGER AND CHARGING INDICATORS

- Twin earth
- LED charging indicators
- Minimum mounting box depth: 25mm-35mm (dependent on wiring conditions)



Code	Size	Finish	Insert
FPR9904NBC	2G	Brushed Chrome	Black
FPR9904NBCG	2G	Brushed Chrome	Grey
FPR9904NBCW	2G	Brushed Chrome	White

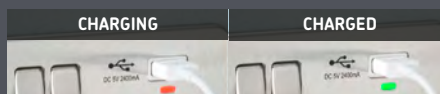

13A SWITCHED SOCKET WITH QUAD USB CHARGER

- 3 ports share 3A
- 1 port dedicated 2.1A
- Minimum mounting box depth: 25mm-35mm (dependent on wiring conditions)

Code	Size	Finish	Insert							
FPR7USB4BC	2G	Brushed Chrome	Black							
FPR7USB4BCG	2G	Brushed Chrome	Grey							
FPR7USB4BCW	2G	Brushed Chrome	White							
FPR7USB4GM	2G	Gunmetal	Black							
FPR7USB4PB	2G	Polished Brass	Black							
FPR7USB4PLW	2G	Pearl	White							
FPR7USB4BB	2G	Brushed Brass	Black							
FPR7USB4PC	2G <td Polished Chrome	Black	FPR7USB4PCG	2G	Polished Chrome	Grey	FPR7USB4PCW	2G	Polished Chrome	White
FPR7USB4PCG	2G	Polished Chrome	Grey							
FPR7USB4PCW	2G	Polished Chrome	White							

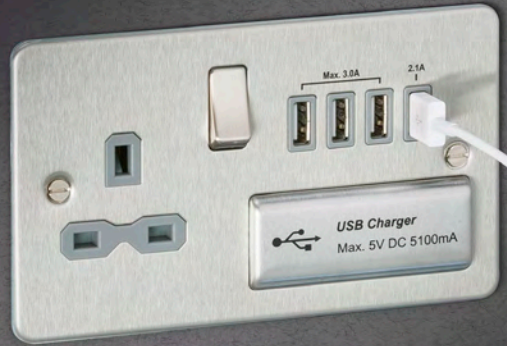



QUAD USB CHARGER OUTLET

- 3 ports share 3A
- 1 port dedicated 2.1A
- Minimum mounting box depth: 25mm-35mm (dependent on wiring conditions)

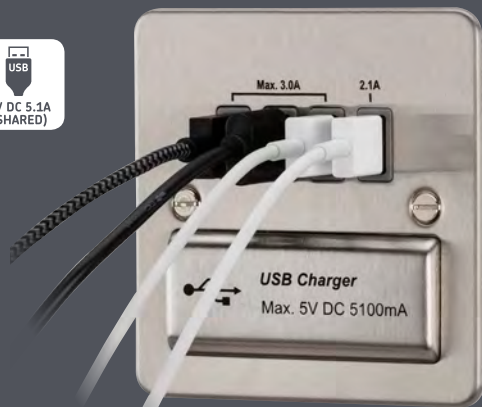

Code	Finish	Insert	Code	Finish	Insert
FPQUADBC	Brushed Chrome	Black	FPQUADPLW	Pearl	White
FPQUADBCG	Brushed Chrome	Grey	FPQUADBB	Brushed Brass	Black
FPQUADBCW	Brushed Chrome	White	FPQUADPC	Polished Chrome	Black
FPQUADGM	Gunmetal	Black	FPQUADPCG	Polished Chrome	Grey
FPQUADPB	Polished Brass	Black	FPQUADPCW	Polished Chrome	White

13A SWITCHED SOCKET WITH DUAL USB CHARGER AND BLUETOOTH SPEAKER

- 3W RMS bluetooth speaker
- Minimum mounting box depth: 25mm-35mm (dependent on wiring conditions)



Code	Size	Finish	Insert
FPR9905BC	2G	Brushed Chrome	Black
FPR9905BCG	2G	Brushed Chrome	Grey
FPR9905BCW	2G	Brushed Chrome	White



INNOVATIONS



2G FLIP-DOWN PHONE HOLDER

- Handy flip-down phone holder for use with double switched sockets with USB charging facility
- Two-piece install - no need to remove socket from wall
- Sits behind the existing double switched socket
- Fold down shelf for supporting your device whilst charging - folds up when not in use

Code	Size	Finish
2GPHBK	2G	Black
2GPHGY	2G	Grey
2GPHW	2G	White

INNOVATIONS

DUAL VOLTAGE SHAVER SOCKETS

- Minimum mounting box depth: 47mm
- 115/230V 20VA rated
- IP41 rated



Code	Finish	Insert
FP8900BC	Brushed Chrome	Black
FP8900BCG	Brushed Chrome	Grey
FP8900BCW	Brushed Chrome	White
FP8900GM	Gunmetal	Black
FP8900PB	Polished Brass	Black

Code	Finish	Insert
FP8900PLW	Pearl	White
FP8900BB	Brushed Brass	Black
FP8900PC	Polished Chrome	Black
FP8900PCG	Polished Chrome	Grey
FP8900PCW	Polished Chrome	White



ROUND PIN SOCKETS

- 5A rated
- Minimum mounting box depth: 25mm • Unswitched



Code	Finish	Insert
FP5ABC	Brushed Chrome	Black
FP5ABCG	Brushed Chrome	Grey
FP5ABCW	Brushed Chrome	White
FP5AGM	Gunmetal	Black
FP5APB	Polished Brass	Black

Code	Finish	Insert
FP5APLW	Pearl	White
FP5ABB	Brushed Brass	Black
FP5APC	Polished Chrome	Black
FP5APCG	Polished Chrome	Grey
FP5APCW	Polished Chrome	White

10AX FAN ISOLATOR SWITCHES

- Triple pole
- Minimum mounting box depth: 16mm



Code	Finish
FP1100BC	Brushed Chrome
FP1100GM	Gunmetal
FP1100PB	Polished Brass

Code	Finish
FP1100PL	Pearl
FP1100BB	Brushed Brass
FP1100PC	Polished Chrome

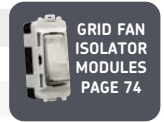

10AX SWITCHES

- Minimum mounting box depth: 16mm



Code	Size	Model	Finish
FP1200BC	1G	Intermediate	Brushed Chrome
FP1200GM	1G	Intermediate	Gunmetal
FP1200PB	1G	Intermediate	Polished Brass
FP1200PL	1G	Intermediate	Pearl
FP1200BB	1G	Intermediate	Brushed Brass
FP1200PC	1G	Intermediate	Polished Chrome

Code	Size	Model	Finish
FP2000BC	1G	2-Way	Brushed Chrome
FP2000GM	1G	2-Way	Gunmetal
FP2000PB	1G	2-Way	Polished Brass
FP2000PL	1G	2-Way	Pearl
FP2000BB	1G	2-Way	Brushed Brass
FP2000PC	1G	2-Way	Polished Chrome

10AX SWITCHES

- Minimum mounting box depth: 16mm

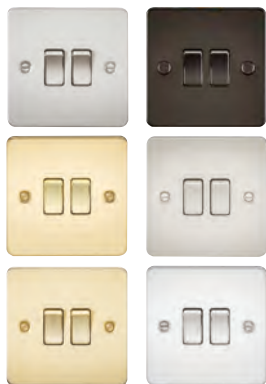

Code	Size	Model	Finish
FP3000BC	2G	2-Way	Brushed Chrome
FP3000GM	2G	2-Way	Gunmetal
FP3000PB	2G	2-Way	Polished Brass
FP3000PL	2G	2-Way	Pearl
FP3000BB	2G	2-Way	Brushed Brass
FP3000PC	2G	2-Way	Polished Chrome



Code	Size	Model	Finish
FP4100BC	4G	2-Way	Brushed Chrome
FP4100GM	4G	2-Way	Gunmetal
FP4100PB	4G	2-Way	Polished Brass
FP4100PL	4G	2-Way	Pearl
FP4100BB	4G	2-Way	Brushed Brass
FP4100PC	4G	2-Way	Polished Chrome



Code	Size	Model	Finish
FP4000BC	3G	2-Way	Brushed Chrome
FP4000GM	3G	2-Way	Gunmetal
FP4000PB	3G	2-Way	Polished Brass
FP4000PL	3G	2-Way	Pearl
FP4000BB	3G	2-Way	Brushed Brass
FP4000PC	3G	2-Way	Polished Chrome

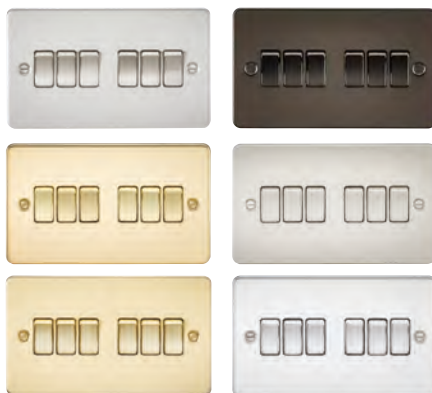

Code	Size	Model	Finish
FP4200BC	6G	2-Way	Brushed Chrome
FP4200GM	6G	2-Way	Gunmetal
FP4200PB	6G	2-Way	Polished Brass
FP4200PL	6G	2-Way	Pearl
FP4200BB	6G	2-Way	Brushed Brass
FP4200PC	6G	2-Way	Polished Chrome



10AX TOGGLE SWITCHES

- Minimum mounting box depth: 16mm



Code	Size	Model	Finish
FP12TOGBC	1G	Intermediate	Brushed Chrome
FP12TOGGM	1G	Intermediate	Gunmetal
FP12TOGPB	1G	Intermediate	Polished Brass
FP12TOGPL	1G	Intermediate	Pearl
FP12TOGBB	1G	Intermediate	Brushed Brass
FP12TOGPC	1G	Intermediate	Polished Chrome



Code	Size	Model	Finish
FP1TOGBC	1G	2-Way	Brushed Chrome
FP1TOGGM	1G	2-Way	Gunmetal
FP1TOGPB	1G	2-Way	Polished Brass
FP1TOGPL	1G	2-Way	Pearl
FP1TOGBB	1G	2-Way	Brushed Brass
FP1TOGPC	1G	2-Way	Polished Chrome



Code	Size	Model	Finish
FP2TOGBC	2G	2-Way	Brushed Chrome
FP2TOGGM	2G	2-Way	Gunmetal
FP2TOGPB	2G	2-Way	Polished Brass



Code	Size	Model	Finish
FP2TOGPL	2G	2-Way	Pearl
FP2TOGBB	2G	2-Way	Brushed Brass
FP2TOGPC	2G	2-Way	Polished Chrome

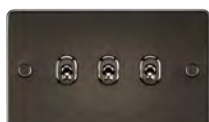

Code	Size	Model	Finish
FP3TOGBC	3G	2-Way	Brushed Chrome
FP3TOGGM	3G	2-Way	Gunmetal
FP3TOGPB	3G	2-Way	Polished Brass
FP3TOGPL	3G	2-Way	Pearl
FP3TOGBB	3G	2-Way	Brushed Brass
FP3TOGPC	3G	2-Way	Polished Chrome



Code	Size	Model	Finish
FP4TOGBC	4G	2-Way	Brushed Chrome
FP4TOGGM	4G	2-Way	Gunmetal
FP4TOGPB	4G	2-Way	Polished Brass
FP4TOGPL	4G	2-Way	Pearl
FP4TOGBB	4G	2-Way	Brushed Brass
FP4TOGPC	4G	2-Way	Polished Chrome

TRAILING-EDGE DIMMERS

- 10-200W incandescent | 5-150W LED
- Minimum mounting box depth: 25mm



Code	Size	Model	Finish
FP2181BC	1G	2-Way	Brushed Chrome
FP2181GM	1G	2-Way	Gunmetal
FP2181PB	1G	2-Way	Polished Brass
FP2181PL	1G	2-Way	Pearl
FP2181BB	1G	2-Way	Brushed Brass
FP2181PC	1G	2-Way	Polished Chrome



Code	Size	Model	Finish
FP2183BC	3G	2-Way	Brushed Chrome
FP2183GM	3G	2-Way	Gunmetal
FP2183PB	3G	2-Way	Polished Brass
FP2183PL	3G	2-Way	Pearl
FP2183BB	3G	2-Way	Brushed Brass
FP2183PC	3G	2-Way	Polished Chrome



Code	Size	Model	Finish
FP2182BC	2G	2-Way	Brushed Chrome
FP2182GM	2G	2-Way	Gunmetal
FP2182PB	2G	2-Way	Polished Brass
FP2182PL	2G	2-Way	Pearl
FP2182BB	2G	2-Way	Brushed Brass
FP2182PC	2G	2-Way	Polished Chrome



Code	Size	Model	Finish
FP2184BC	4G	2-Way	Brushed Chrome
FP2184GM	4G	2-Way	Gunmetal
FP2184PB	4G	2-Way	Polished Brass
FP2184PL	4G	2-Way	Pearl
FP2184BB	4G	2-Way	Brushed Brass
FP2184PC	4G	2-Way	Polished Chrome



FUSED SPUR UNITS

- 13A rated
- Double pole switches where applicable
- Minimum mounting box depth: 25mm



Code	Model	Finish
FP6000BC	Unswitched	Brushed Chrome
FP6000GM	Unswitched	Gunmetal
FP6000PB	Unswitched	Polished Brass
FP6000PL	Unswitched	Pearl
FP6000BB	Unswitched	Brushed Brass
FP6000PC	Unswitched	Polished Chrome

Code	Model	Finish
FP6300NBC	Switched + Neon	Brushed Chrome
FP6300NGM	Switched + Neon	Gunmetal
FP6300NPB	Switched + Neon	Polished Brass
FP6300NPL	Switched + Neon	Pearl
FP6300NBB	Switched + Neon	Brushed Brass
FP6300NPC	Switched + Neon	Polished Chrome



Code	Model	Finish
FP6300BC	Switched	Brushed Chrome
FP6300GM	Switched	Gunmetal
FP6300PB	Switched	Polished Brass
FP6300PL	Switched	Pearl
FP6300BB	Switched	Brushed Brass
FP6300PC	Switched	Polished Chrome

Code	Model	Finish
FP6300FBC	Switched + Neon + Flex Outlet (front)	Brushed Chrome
FP6300FGM	Switched + Neon + Flex Outlet (front)	Gunmetal
FP6300FPB	Switched + Neon + Flex Outlet (front)	Polished Brass
FP6300FPL	Switched + Neon + Flex Outlet (front)	Pearl
FP6300FBB	Switched + Neon + Flex Outlet (front)	Brushed Brass
FP6300FPC	Switched + Neon + Flex Outlet (front)	Polished Chrome

20A SWITCHES

- Double pole switches
- Minimum mounting box depth: 25mm



Code	Model	Finish
FP8341BC	Switched	Brushed Chrome
FP8341GM	Switched	Gunmetal
FP8341PB	Switched	Polished Brass
FP8341PL	Switched	Pearl
FP8341BB	Switched	Brushed Brass
FP8341PC	Switched	Polished Chrome

Code	Model	Finish
FP8341FBC	Switched + Neon + Flex Outlet (front)	Brushed Chrome
FP8341FGM	Switched + Neon + Flex Outlet (front)	Gunmetal
FP8341FPB	Switched + Neon + Flex Outlet (front)	Polished Brass
FP8341FPL	Switched + Neon + Flex Outlet (front)	Pearl
FP8341FBB	Switched + Neon + Flex Outlet (front)	Brushed Brass
FP8341FPC	Switched + Neon + Flex Outlet (front)	Polished Chrome



Code	Model	Finish
FP8341NBC	Switched + Neon	Brushed Chrome
FP8341NGM	Switched + Neon	Gunmetal
FP8341NPB	Switched + Neon	Polished Brass

Code	Model	Finish
FP8341NPL	Switched + Neon	Pearl
FP8341NBB	Switched + Neon	Brushed Brass
FP8341NPC	Switched + Neon	Polished Chrome





45A COOKER SWITCHES

- Double pole switches
- Minimum mounting box depth: 47mm
- Neon indicator



Code	Finish
FP8331NBC	Brushed Chrome
FP8331NGM	Gunmetal
FP8331NPB	Polished Brass
FP8331NPL	Pearl
FP8331NBB	Brushed Brass
FP8331NPC	Polished Chrome



Code	Finish
FP8332NBC	Brushed Chrome
FP8332NGM	Gunmetal
FP8332NPB	Polished Brass
FP8332NPL	Pearl
FP8332NBB	Brushed Brass
FP8332NPC	Polished Chrome

45A COOKER SWITCH AND SOCKET WITH NEONS

- Double pole switches
- 13A switched socket
- Minimum mounting box depth: 47mm

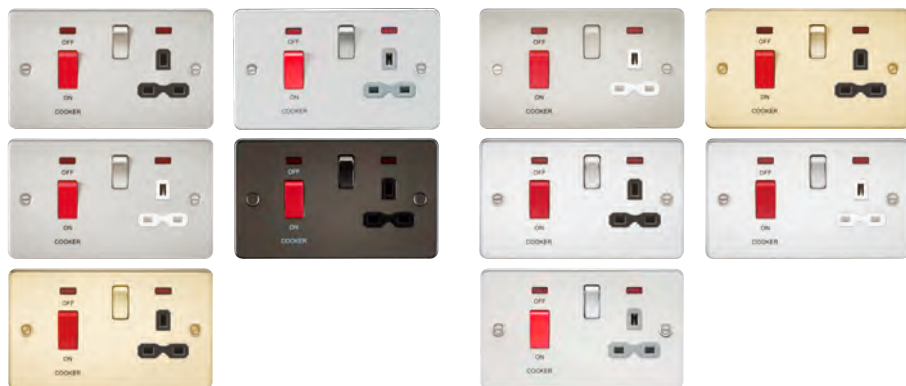

Code	Finish	Insert
FPR8333NBC	Brushed Chrome	Black
FPR8333NBCG	Brushed Chrome	Grey
FPR8333NBCW	Brushed Chrome	White
FPR8333NGM	Gunmetal	Black
FPR8333NPB	Polished Brass	Black

Code	Finish	Insert
FPR8333NPLW	Pearl	White
FPR8333NBB	Brushed Brass	Black
FPR8333NPC	Polished Chrome	Black
FPR8333NPCW	Polished Chrome	White
FPR8333NPCG	Polished Chrome	Grey

TELEPHONE SOCKETS

- Minimum mounting box depth: 25mm



Code	Model	Finish
FP7300BC	Master	Brushed Chrome
FP7300GM	Master	Gunmetal
FP7300PB	Master	Polished Brass
FP7300PL	Master	Pearl
FP7300BB	Master	Brushed Brass
FP7300PC	Master	Polished Chrome

Code	Model	Finish
FP7400BC	Extension	Brushed Chrome
FP7400GM	Extension	Gunmetal
FP7400PB	Extension	Polished Brass
FP7400PL	Extension	Pearl
FP7400BB	Extension	Brushed Brass
FP7400PC	Extension	Polished Chrome



NETWORK OUTLETS

- UTP CAT5e
- Minimum mounting box depth: 35mm



Code	Model	Finish
FPRJ45BC	RJ45	Brushed Chrome
FPRJ45GM	RJ45	Gunmetal
FPRJ45PB	RJ45	Polished Brass
FPRJ45PL	RJ45	Pearl
FPRJ45BB	RJ45	Brushed Brass
FPRJ45PC	RJ45	Polished Chrome



TV OUTLET

- Minimum mounting box depth: 25mm

Code	Model	Finish
FP0100BC	Non-isolated	Brushed Chrome
FP0100GM	Non-isolated	Gunmetal
FP0100PB	Non-isolated	Polished Brass
FP0100PL	Non-isolated	Pearl
FP0100BB	Non-isolated	Brushed Brass
FP0100PC	Non-isolated	Polished Chrome





SAT TV OUTLET

- Minimum mounting box depth: 25mm



Code	Model	Finish
FP0150BC	Non-isolated	Brushed Chrome
FP0150GM	Non-isolated	Gunmetal
FP0150PB	Non-isolated	Polished Brass
FP0150PL	Non-isolated	Pearl
FP0150BB	Non-isolated	Brushed Brass
FP0150PC	Non-isolated	Polished Chrome

BLANKING PLATES

Code	Size	Finish
FP8350BC	1G	Brushed Chrome
FP8350GM	1G	Gunmetal
FP8350PB	1G	Polished Brass
FP8350PL	1G	Pearl
FP8350BB	1G	Brushed Brass
FP8350PC	1G	Polished Chrome

TV AND SAT TV OUTLET

- Minimum mounting box depth: 25mm



Code	Model	Finish
FP0140BC	Isolated	Brushed Chrome
FP0140GM	Isolated	Gunmetal
FP0140PB	Isolated	Polished Brass
FP0140PL	Isolated	Pearl
FP0140BB	Isolated	Brushed Brass
FP0140PC	Isolated	Polished Chrome

Code	Size	Finish
FP8360BC	2G	Brushed Chrome
FP8360GM	2G	Gunmetal
FP8360PB	2G	Polished Brass
FP8360PL	2G	Pearl
FP8360BB	2G	Brushed Brass
FP8360PC	2G	Polished Chrome

MODULAR FRAMES

- For use with 25mm x 50mm and/or 50mm x 50mm euro modules



Code	Size	Finish
FP1GBC	1 Module	Brushed Chrome
FP1GGM	1 Module	Gunmetal
FP1GPB	1 Module	Polished Brass

Code	Size	Finish
FP1GPL	1 Module	Pearl
FP1GBB	1 Module	Brushed Brass
FP1GPC	1 Module	Polished Chrome



Modular Inserts available on pages 122-125



Code	Size	Finish
FP2GBC	1-2 Modules	Brushed Chrome
FP2GGM	1-2 Modules	Gunmetal
FP2GPB	1-2 Modules	Polished Brass
FP2GPL	1-2 Modules	Pearl
FP2GBB	1-2 Modules	Brushed Brass
FP2GPC	1-2 Modules	Polished Chrome

Code	Size	Finish
FP4GBC	2-4 Modules	Brushed Chrome
FP4GGM	2-4 Modules	Gunmetal
FP4GPB	2-4 Modules	Polished Brass
FP4GPL	2-4 Modules	Pearl
FP4GBB	2-4 Modules	Brushed Brass
FP4GPC	2-4 Modules	Polished Chrome



To indicate preferred finish, replace xx with PC (Polished Chrome) or BC (Brushed Chrome)

GRID FACEPLATES

- Requires grid mounting frame (sold separately)
- For use with Knightsbridge Grid Accessories only

Code	Size
GDFP001xx	1G
GDFP002xx	2G
GDFP003xx	3G
GDFP004xx	4G
GDFP006xx	6G
GDFP008xx	8G
GDFP009xx	9G
GDFP012xx	12G

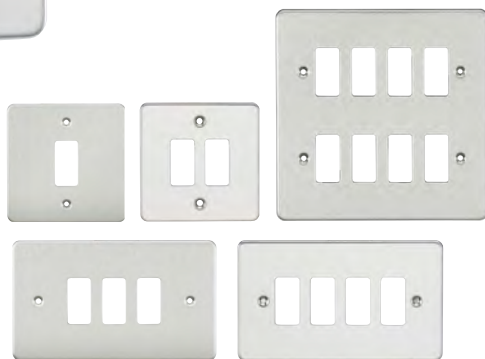

GRID MOUNTING FRAMES

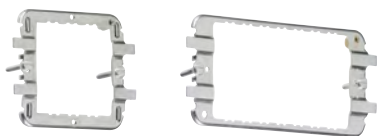

Code	Size
GDF001F	1-2G
GDF002F	3-4G

ELECTRICAL SCREWS

- Flat-head - slotted
- Countersunk



Code	Model	Qty
C-SCREW50B	50mm Brass	100
C-SCREW50N	50mm Nickel	100
C-SCREW50BK	50mm Black Nickel/Gunmetal	100

20AX GRID SWITCH MODULES



Code	Model
GDM001xx	2-Way SP
GDM002xx	DP
GDM003xx	DP + LED Indicator
GDM004xx	2-Way SP (centre-off)
GDM005xx	Intermediate
GDM006xx	2-Way SP Retractive (marked "PRESS")

CREATE 2G
INTERMEDIATE
SWITCHES WITH
GDM005xx



20AX GRID KEY SWITCH MODULES

- Supplied with test key



Code	Model
GDM007xx	2-Way SP (marked "EMG LTG TEST")
GDM008xx	DP (marked "EMG LTG TEST")
GDM009xx	2-Way SP
GDM010xx	DP
GDKEY	Spare Key

GRID TRAILING-EDGE DIMMER MODULES

- 10-200W incandescent | 10-100W LED



Code	Model
GDM014xx	1-Way Trailing - Edge Dimmer (Press)
GDM200xx	2-Way Trailing - Edge Dimmer (Rotary)





To indicate preferred finish, replace xx with PC (Polished Chrome) or BC (Brushed Chrome)

GRID DUMMY DIMMER MODULE

- Push on/off function only
- Ideal for situations where you require one position to look like a dimmer but act like a switch



Code	Model
GDM022xx	6A 2-Way

10A GRID FAN ISOLATOR MODULES

- Triple pole
- Requires single grid position only



Code	Model
GDM020xx	Fan Isolator Switch Module
GDM021xx	Fan Isolator Key Switch Module (supplied with test key)

GRID DUAL USB CHARGER MODULE

- Requires two grid positions



Code	Model
GDM016xx	Dual USB Charger Module

MISCELLANEOUS GRID MODULES



Code	Model
GDM011xx	Fuse Holder (13A)
GDM012xx	Flex Outlet (max. 10mm)
GDM013xx	Blank
GDM017	Indicator - Green
GDM018	Indicator - Red
GDM019	Indicator - Orange

GRID ROCKER COVERS

- Easy to install
- Replace an existing rocker with an engraved version indicating the appliance it refers to



Code	Model
GDBOILxx	Boiler
GDDISHxx	Dishwasher
GDFANxx	Fan
GDWASHxx	Washing Machine
GDDRYxx	Tumble Dryer
GDCOOKxx	Cooker Hood
GDHOBxx	Hob
GDOVENxx	Oven
GDMICROxx	Microwave
GDFRIDxx	Fridge Freezer



KEEP UP TO DATE WITH NEW PRODUCTS, SPECIAL OFFERS, AND MORE



Knightsbridge

 @KnightsbridgeML







 @Knightsbridgemla

 @Knightsbridge

 @Knightsbridgemla



FINISHES

-  BRUSHED CHROME
-  MATT WHITE
-  BLACK NICKEL
-  POLISHED CHROME
-  MATT BLACK
-  POLISHED BRASS

INSERT OPTIONS

- BLACK
- WHITE
- GREY



SCREWLESS

Available in 6 stunning finishes, with a screwless flat plate ultra slim profile design. Very easy to install and the perfect upgrade for any environment

13A Switched Sockets	80
Switched Sockets with USB	81
FASTCHARGE USB Sockets	82-83
Sockets with USB Charging Indicators / Cooker Sockets with USB	84
Quad USB Sockets	85
Bluetooth Speaker Sockets / Phone Holder	86-87
Shaver Sockets	88
Round Pin Sockets / Fan Isolator Switches	89
10AX Switches	90-91
10AX Toggle Switches	92
Dimmers	93-94
Fused Spur Units	94-95
20A Switches	95
Plinth Lights / Key Car Switch	96
Cooker Switches and Sockets	97
Media Outlets / Blanking Plates	98-99
Modular Frames / Screws	100
Grid Wiring Accessories	101-103



LONG-LASTING

Robust full metal housing

COLOUR MATCHING

Matching metal rockers with no surround

DOUBLE POLE SWITCHES

On selected products, for additional safety



Single plate size:
87.5mm x 87.5mm

Double plate size:
87.5mm x 147.5mm

Plate projection:
4.3mm

UNIQUE SOCKET DESIGN

Socket concealed by plug once inserted

LOW PROFILE DESIGN

Plate projection
4.3mm
(including gasket)



MOISTURE TRANSFER RESISTANT

Integrated moisture gasket - barely visible when installed

HIGH INTEGRITY EARTHING

Twin earthing terminals (on double switched sockets), for compliance with BS 7671:2008 regulation 543-7

High quality US IC's and USB controllers



15

YEAR WARRANTY*

*2 YEARS ON ELECTRONIC PRODUCTS





13A DP SWITCHED SOCKETS

- Twin earth
- Double pole switches
- Minimum mounting box depth: 25mm



Code	Size	Finish	Insert
SFR9000BC	2G	Brushed Chrome	Black
SFR9000BCG	2G	Brushed Chrome	Grey
SFR9000BCW	2G	Brushed Chrome	White
SFR9000MW	2G	Matt White	White
SFR9000BN	2G	Black Nickel	Black
SFR9000PC	2G	Polished Chrome	Black

Code	Size	Finish	Insert
SFR9000PCG	2G	Polished Chrome	Grey
SFR9000PCW	2G	Polished Chrome	White
SFR9000MB	2G	Matt Black (Chrome Rockers)	Black
SFR9000MBB	2G	Matt Black	Black
SFR9000PB	2G	Polished Brass	Black
SFR9000PBW	2G	Polished Brass	White



Code	Size	Finish	Insert
SFR7000BC	1G	Brushed Chrome	Black
SFR7000BCG	1G	Brushed Chrome	Grey
SFR7000BCW	1G	Brushed Chrome	White
SFR7000MW	1G	Matt White	White
SFR7000BN	1G	Black Nickel	Black
SFR7000PC	1G	Polished Chrome	Black

Code	Size	Finish	Insert
SFR7000PCG	1G	Polished Chrome	Grey
SFR7000PCW	1G	Polished Chrome	White
SFR7000MB	1G	Matt Black (Chrome Rocker)	Black
SFR7000MBB	1G	Matt Black	Black
SFR7000PB	1G	Polished Brass	Black
SFR7000PBW	1G	Polished Brass	White

13A 2G SWITCHED SOCKET WITH DUAL USB CHARGER

- Twin earth
- Minimum mounting box depth: 25mm-35mm (dependent on wiring conditions)



Code	Size	Finish	Insert
SFR9224BC	2G	Brushed Chrome	Black
SFR9224BCG	2G	Brushed Chrome	Grey
SFR9224BCW	2G	Brushed Chrome	White
SFR9224MW	2G	Matt White	White
SFR9224BN	2G	Black Nickel	Black
SFR9224PC	2G	Polished Chrome	Black
SFR9224PCG	2G	Polished Chrome	Grey
SFR9224PCW	2G	Polished Chrome	White
SFR9224MB	2G	Matt Black (Chrome Rockers)	Black
SFR9224MBB	2G	Matt Black	Black
SFR9224PB	2G	Polished Brass	Black
SFR9224PBW	2G	Polished Brass	White

13A 1G SWITCHED SOCKET WITH DUAL USB CHARGER

- Minimum mounting box depth: 25mm-35mm (dependent on wiring conditions)



Code	Size	Finish	Insert
SFR9901BC	1G	Brushed Chrome	Black
SFR9901BCG	1G	Brushed Chrome	Grey
SFR9901BCW	1G	Brushed Chrome	White
SFR9901MW	1G	Matt White	White
SFR9901BN	1G	Black Nickel	Black
SFR9901PC	1G	Polished Chrome	Black
SFR9901PCG	1G	Polished Chrome	Grey
SFR9901PCW	1G	Polished Chrome	White
SFR9901MB	1G	Matt Black (Chrome Rocker)	Black
SFR9901MBB	1G	Matt Black	Black
SFR9901PB	1G	Polished Brass	Black
SFR9901PBW	1G	Polished Brass	White



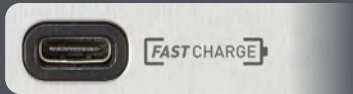

TYPE-C PORT FASTCHARGE USB

- 5V DC 3A - up to 15W (FASTCHARGE mode)
- 9V DC 2A - up to 18W (FASTCHARGE mode)
- 12V DC 1.5A - up to 18W (FASTCHARGE mode)
- The Type A port offers up to 5V DC 2A when FASTCHARGE is not activated. When FASTCHARGE is activated, the port will output at 5V DC 1A



Code	Finish	Insert
SFR9907BC	Brushed Chrome	Black
SFR9907BCG	Brushed Chrome	Grey
SFR9907BCW	Brushed Chrome	White
SFR9907MW	Matt White	White
SFR9907MBB	Matt Black	Black

* Phones compatible with FAST CHARGING standards i.e. QC3.0, PD FASTCHARGE

FAST CHARGE



50% CHARGE IN ONLY 30 MINUTES!*



13A 2G SWITCHED SOCKETS WITH DUAL USB CHARGER (TYPE-A / TYPE-C FASTCHARGE PORT)

- Double pole switches • Twin earth • Over voltage category III - suitable for use in commercial installations
- Certified to the latest socket standard BS 1363-2:2016
- Certified to the latest British safety standards
- ErP ready to ensure power saving when not in use
- USB certified cables are recommended for safety and performance with all USB chargers
- 5V DC 4.0A - output: max. 3A from FASTCHARGE port, max. 2A from standard port (1A when FASTCHARGE is in operation)



TYPE-A PORT FASTCHARGE USB

- 5V DC 2A - up to 10W (standard mode)
- 9V DC 2A - up to 18W (FASTCHARGE mode)
- 12V DC 1.5A - up to 18W (FASTCHARGE mode)
- The standard port offers up to 5V DC 2A when FASTCHARGE is not activated. When FASTCHARGE is activated this port will only output at 5V DC 1A

Code	Finish	Insert
SFR9906BC	Brushed Chrome	Black
SFR9906BCG	Brushed Chrome	Grey
SFR9906BCW	Brushed Chrome	White
SFR9906MW	Matt White	White
SFR9906MBB	Matt Black	Black



13A 2G SWITCHED SOCKET WITH DUAL USB CHARGER AND CHARGING INDICATORS

- Twin earth • Charging indicators (indicator off when not in use)
- Minimum mounting box depth: 25mm–35mm (dependent on wiring conditions)



Code	Finish	Insert
SFR9904NBC	Brushed Chrome	Black
SFR9904NBCG	Brushed Chrome	Grey
SFR9904NBCW	Brushed Chrome	White

Code	Finish	Insert
SFR9904NMW	Matt White	White
SFR9904NMBB	Matt Black	Black

45A SWITCHES AND SOCKETS WITH DUAL USB CHARGER

- Double pole 45A switch • 13A Switched socket • Minimum mounting box depth: 47mm



Code	Finish	Insert
SFR8333UBC	Brushed Chrome	Black
SFR8333UBCG	Brushed Chrome	Grey
SFR8333UBCW	Brushed Chrome	White

Code	Finish	Insert
SFR8333UMW	Matt White	White
SFR8333UMBB	Matt Black	Black

QUAD USB CHARGER OUTLET

- 3 ports share 3A • 1 port dedicated 2.1A
- Minimum mounting box depth: 25mm-35mm (dependent on wiring conditions)

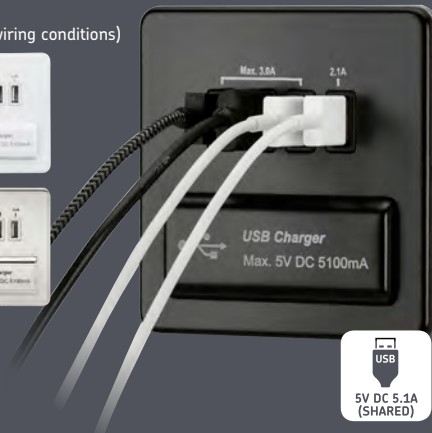

Code	Finish	Insert
SFQUADBC	Brushed Chrome	Black
SFQUADBCG	Brushed Chrome	Grey
SFQUADBCW	Brushed Chrome	White
SFQUADMW	Matt White	White
SFQUADBN	Black Nickel	Black
SFQUADPC	Polished Chrome	Black

Code	Finish	Insert
SFQUADPCG	Polished Chrome	Grey
SFQUADPCW	Polished Chrome	White
SFQUADMB	Matt Black	Black
SFQUADPB	Polished Brass	Black
SFQUADPBW	Polished Brass	White

13A SWITCHED SOCKET WITH QUAD USB CHARGER

- USB charging rate: 5V DC 5.1A (shared) • 3 ports share 3A • 1 port dedicated 2.1A
- Minimum mounting box depth: 25mm-35mm (dependent on wiring conditions)



Code	Finish	Insert
SFR7USB4BC	Brushed Chrome	Black
SFR7USB4BCG	Brushed Chrome	Grey
SFR7USB4BCW	Brushed Chrome	White
SFR7USB4MW	Matt White	White
SFR7USB4BN	Black Nickel	Black
SFR7USB4PC	Polished Chrome	Black

Code	Finish	Insert
SFR7USB4PCG	Polished Chrome	Grey
SFR7USB4PCW	Polished Chrome	White
SFR7USB4MB	Matt Black (Chrome Rocker)	Black
SFR7USB4MBB	Matt Black	Black
SFR7USB4PB	Polished Brass	Black
SFR7USB4PBW	Polished Brass	White

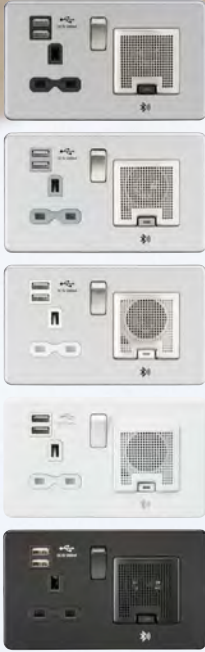

FLUSH / SURFACE MOUNTED BLUETOOTH SPEAKER

- 3W RMS bluetooth speaker
- Minimum mounting box depth: 35mm



1G
SURFACE
BOXES
on Page 143



Code	Finish
SFBLUEBC	Brushed Chrome
SFBLUEMW	Matt White
SFBLUEMBB	Matt Black

INTEGRATED BLUETOOTH + USB

13A SWITCHED SOCKET WITH DUAL USB CHARGER AND BLUETOOTH SPEAKER

- 3W RMS bluetooth speaker
- Minimum mounting box depth: 25mm-35mm (dependent on wiring conditions)



Code	Finish	Insert
SFR9905BC	Brushed Chrome	Black
SFR9905BCG	Brushed Chrome	Grey
SFR9905BCW	Brushed Chrome	White

Code	Finish	Insert
SFR9905MW	Matt White	White
SFR9905MBB	Matt Black	Black

2G FLIP-DOWN PHONE HOLDER

- Flip-down phone holder for use with double switched sockets with USB charging facility
- Two-piece install - no need to remove socket from wall
- Sits behind the existing double switched socket
- Fold down shelf for supporting your device whilst charging - folds up when not in use

Code	Finish
2GPHBK	Black
2GPHGY	Grey
2GPHWH	White

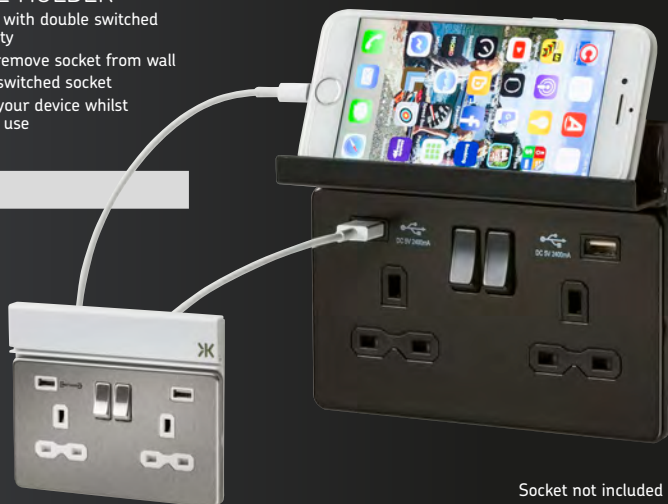

Socket not included



DUAL VOLTAGE SHAVER SOCKETS

- Minimum mounting box depth: 47mm
- 115/230V 20VA rated
- IP41 rated



Code	Finish	Insert
SF8900BC	Brushed Chrome	Black
SF8900BCG	Brushed Chrome	Grey
SF8900BCW	Brushed Chrome	White
SF8900MW	Matt White	White
SF8900BN	Black Nickel	Black
SF8900PC	Polished Chrome	Black

Code	Finish	Insert
SF8900PCG	Polished Chrome	Grey
SF8900PCW	Polished Chrome	White
SF8900MB	Matt Black	Black
SF8900PB	Polished Brass	Black
SF8900PBW	Polished Brass	White

ROUND PIN SOCKETS

- 5A rated
- Unswitched
- Minimum mounting box depth: 25mm



Code	Finish	Insert
SF5ABC	Brushed Chrome	Black
SF5ABCG	Brushed Chrome	Grey
SF5ABCW	Brushed Chrome	White
SF5AMW	Matt White	White
SF5ABN	Black Nickel	Black
SF5APC	Polished Chrome	Black

Code	Finish	Insert
SF5APCG	Polished Chrome	Grey
SF5APCW	Polished Chrome	White
SF5AMB	Matt Black	Black
SF5APB	Polished Brass	Black
SF5APBW	Polished Brass	White

10AX FAN ISOLATOR SWITCHES

- Triple pole
- Minimum mounting box depth: 16mm



GRID FAN
ISOLATOR
MODULES
PAGE 102

Code	Finish
SF1100BC	Brushed Chrome
SF1100MW	Matt White
SF1100BN	Black Nickel
SF1100PC	Polished Chrome

Code	Finish
SF1100MB	Matt Black (Chrome Rocker)
SF1100MBB	Matt Black
SF1100PB	Polished Brass



10AX SWITCHES

• Minimum mounting box depth: 16mm



Code	Size	Model	Finish
SF1200BC	1G	Intermediate	Brushed Chrome
SF1200MW	1G	Intermediate	Matt White
SF1200BN	1G	Intermediate	Black Nickel
SF1200PC	1G	Intermediate	Polished Chrome
SF1200MB	1G	Intermediate	Matt Black (Chrome Rocker)
SF1200MBB	1G	Intermediate	Matt Black
SF1200PB	1G	Intermediate	Polished Brass

Code	Size	Model	Finish
SF3000BC	2G	2-Way	Brushed Chrome
SF3000MW	2G	2-Way	Matt White
SF3000BN	2G	2-Way	Black Nickel
SF3000PC	2G	2-Way	Polished Chrome
SF3000MB	2G	2-Way	Matt Black (Chrome Rockers)
SF3000MBB	2G	2-Way	Matt Black
SF3000PB	2G	2-Way	Polished Brass

Code	Size	Model	Finish
SF2000BC	1G	2-Way	Brushed Chrome
SF2000MW	1G	2-Way	Matt White
SF2000BN	1G	2-Way	Black Nickel
SF2000PC	1G	2-Way	Polished Chrome
SF2000MB	1G	2-Way	Matt Black (Chrome Rocker)
SF2000MBB	1G	2-Way	Matt Black
SF2000PB	1G	2-Way	Polished Brass

10AX SWITCHES

- Minimum mounting box depth: 16mm

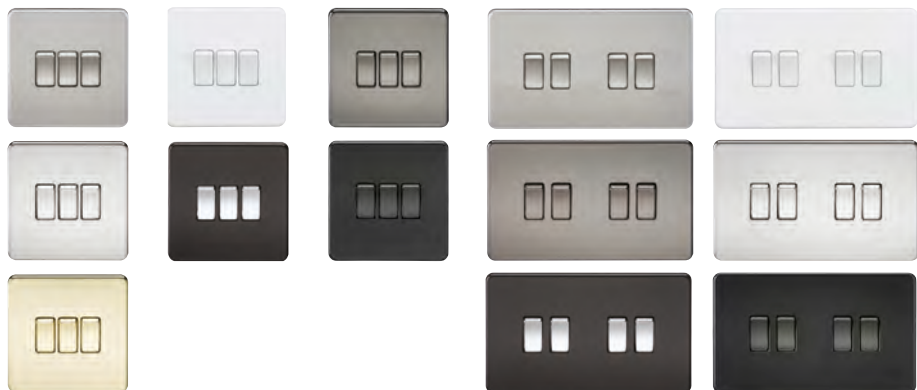

Code	Size	Model	Finish
SF4000BC	3G	2-Way	Brushed Chrome
SF4000MW	3G	2-Way	Matt White
SF4000BN	3G	2-Way	Black Nickel
SF4000PC	3G	2-Way	Polished Chrome
SF4000MB	3G	2-Way	Matt Black (Chrome Rockers)
SF4000MBB	3G	2-Way	Matt Black
SF4000PB	3G	2-Way	Polished Brass



Code	Size	Model	Finish
SF4100BC	4G	2-Way	Brushed Chrome
SF4100MW	4G	2-Way	Matt White
SF4100BN	4G	2-Way	Black Nickel
SF4100PC	4G	2-Way	Polished Chrome
SF4100MB	4G	2-Way	Matt Black (Chrome Rockers)
SF4100MBB	4G	2-Way	Matt Black
SF4100PB	4G	2-Way	Polished Brass



Code	Size	Model	Finish
SF4200BC	6G	2-Way	Brushed Chrome
SF4200MW	6G	2-Way	Matt White
SF4200BN	6G	2-Way	Black Nickel
SF4200PC	6G	2-Way	Polished Chrome

Code	Size	Model	Finish
SF4200MB	6G	2-Way	Matt Black (Chrome Rockers)
SF4200MBB	6G	2-Way	Matt Black
SF4200PB	6G	2-Way	Polished Brass



10AX TOGGLE SWITCHES

• Minimum mounting box depth: 16mm



Code	Size	Model	Finish
SF12TOGBC	1G	Intermediate	Brushed Chrome
SF12TOGBN	1G	Intermediate	Black Nickel
SF12TOGPC	1G	Intermediate	Polished Chrome
SF12TOGPB	1G	Intermediate	Polished Brass

Code	Size	Model	Finish
SF1TOGBC	1G	2-Way	Brushed Chrome
SF1TOGBN	1G	2-Way	Black Nickel
SF1TOGPC	1G	2-Way	Polished Chrome
SF1TOGPB	1G	2-Way	Polished Brass



Code	Size	Model	Finish
SF3TOGBC	3G	2-Way	Brushed Chrome
SF3TOGBN	3G	2-Way	Black Nickel
SF3TOGPC	3G	2-Way	Polished Chrome
SF3TOGPB	3G	2-Way	Polished Brass



Code	Size	Model	Finish
SF2TOGBC	2G	2-Way	Brushed Chrome
SF2TOGBN	2G	2-Way	Black Nickel
SF2TOGPC	2G	2-Way	Polished Chrome
SF2TOGPB	2G	2-Way	Polished Brass



Code	Size	Model	Finish
SF4TOGBC	4G	2-Way	Brushed Chrome
SF4TOGBN	4G	2-Way	Black Nickel
SF4TOGPC	4G	2-Way	Polished Chrome
SF4TOGPB	4G	2-Way	Polished Brass

TRAILING-EDGE DIMMERS

- 10-200W incandescent | 5-150W LED
- Minimum mounting box depth: 25mm



Code	Size	Model	Finish
SF2181MW	1G	2-Way	Matt White
SF2181BN	1G	2-Way	Black Nickel
SF2181PC	1G	2-Way	Polished Chrome
SF2181BC	1G	2-Way	Brushed Chrome
SF2181MB	1G	2-Way	Matt Black (Chrome Cap)
SF2181MBB	1G	2-Way	Matt Black
SF2181PB	1G	2-Way	Polished Brass

Code	Size	Model	Finish
SF2182BC	2G	2-Way	Brushed Chrome
SF2182MW	2G	2-Way	Matt White
SF2182BN	2G	2-Way	Black Nickel
SF2182PC	2G	2-Way	Polished Chrome
SF2182MB	2G	2-Way	Matt Black (Chrome Caps)
SF2182MBB	2G	2-Way	Matt Black
SF2182PB	2G	2-Way	Polished Brass



Code	Size	Model	Finish
SF2183BC	3G	2-Way	Brushed Chrome
SF2183MW	3G	2-Way	Matt White
SF2183BN	3G	2-Way	Black Nickel
SF2183PC	3G	2-Way	Polished Chrome

Code	Size	Model	Finish
SF2183MB	3G	2-Way	Matt Black (Chrome Caps)
SF2183MBB	3G	2-Way	Matt Black
SF2183PB	3G	2-Way	Polished Brass



TRAILING-EDGE DIMMERS

- 10-200W incandescent | 5-150W LED
- Minimum mounting box depth: 25mm



Code	Size	Model	Finish
SF2184BC	4G	2-Way	Brushed Chrome
SF2184MW	4G	2-Way	Matt White
SF2184BN	4G	2-Way	Black Nickel
SF2184PC	4G	2-Way	Polished Chrome

Code	Size	Model	Finish
SF2184MB	4G	2-Way	Matt Black (Chrome Caps)
SF2184MBB	4G	2-Way	Matt Black
SF2184PB	4G	2-Way	Polished Brass

FUSED SPUR UNITS

- 13A rated
- Double pole switches where applicable
- Minimum mounting box depth: 25mm



Code	Model	Finish
SF6000BC	Unswitched	Brushed Chrome
SF6000MW	Unswitched	Matt White
SF6000BN	Unswitched	Black Nickel
SF6000PC	Unswitched	Polished Chrome
SF6000MB	Unswitched	Matt Black (Chrome Cover)
SF6000MBB	Unswitched	Matt Black
SF6000PB	Unswitched	Polished Brass

Code	Model	Finish
SF6300BC	Switched	Brushed Chrome
SF6300MW	Switched	Matt White
SF6300BN	Switched	Black Nickel
SF6300PC	Switched	Polished Chrome
SF6300MB	Switched	Matt Black (Chrome Cover + Rocker)
SF6300MBB	Switched	Matt Black
SF6300PB	Switched	Polished Brass

FUSED SPUR UNITS

- 13A rated
- Double pole switches
- Minimum mounting box depth: 25mm



Code	Model	Finish
SF6300NBC	Switched + Neon	Brushed Chrome
SF6300NMW	Switched + Neon	Matt White
SF6300NBN	Switched + Neon	Black Nickel
SF6300NPC	Switched + Neon	Polished Chrome

Code	Model	Finish
SF6300NMB	Switched + Neon	Matt Black (Chrome Cover + Rocker)
SF6300NMBB	Switched + Neon	Matt Black
SF6300NPB	Switched + Neon	Polished Brass

20A SWITCHES

- Double pole switches
- Minimum mounting box depth: 25mm



Code	Model	Finish
SF8341BC	Switched	Brushed Chrome
SF8341MW	Switched	Matt White
SF8341BN	Switched	Black Nickel
SF8341PC	Switched	Polished Chrome

Code	Model	Finish
SF8341MB	Switched	Matt Black (Chrome Rocker)
SF8341MBB	Switched	Matt Black
SF8341PB	Switched	Polished Brass



Code	Model	Finish
SF8341NBC	Switched + Neon	Brushed Chrome
SF8341NMW	Switched + Neon	Matt White
SF8341NBN	Switched + Neon	Black Nickel
SF8341NPC	Switched + Neon	Polished Chrome

Code	Model	Finish
SF8341NMB	Switched + Neon	Matt Black (Chrome Rocker)
SF8341NMBB	Switched + Neon	Matt Black
SF8341NPB	Switched + Neon	Polished Brass

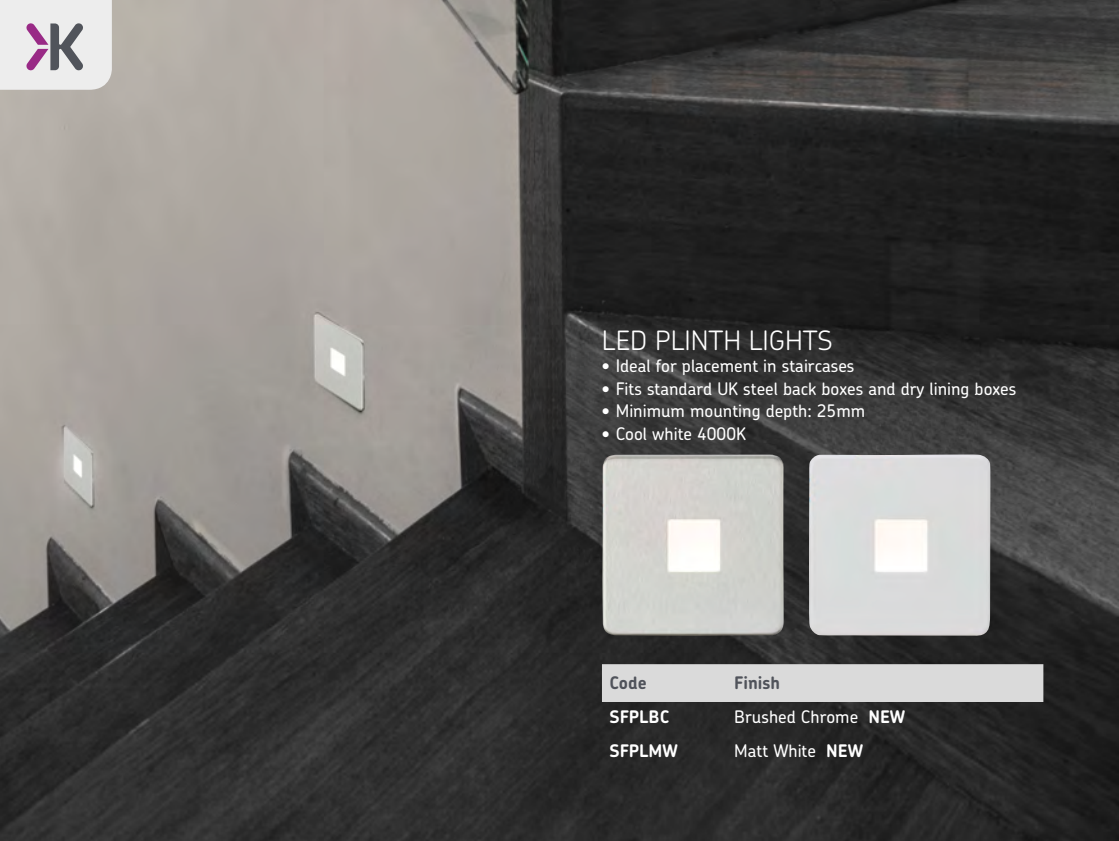

LED PLINTH LIGHTS

- Ideal for placement in staircases
- Fits standard UK steel back boxes and dry lining boxes
- Minimum mounting depth: 25mm
- Cool white 4000K

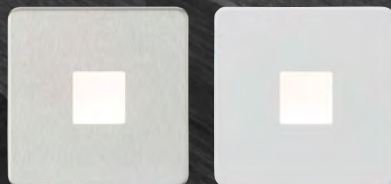

Code	Finish
SFPLBC	Brushed Chrome NEW
SFPLMW	Matt White NEW

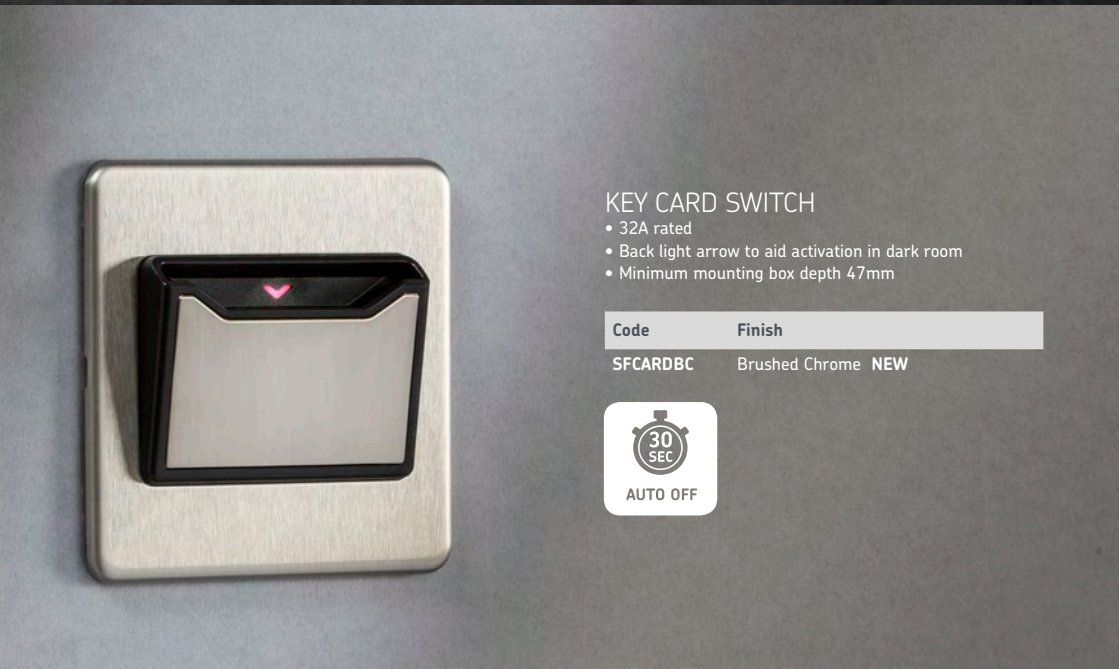

KEY CARD SWITCH

- 32A rated
- Back light arrow to aid activation in dark room
- Minimum mounting box depth 47mm

Code	Finish
SFCARDBC	Brushed Chrome NEW



45A COOKER SWITCHES

- Double pole switches
- Minimum mounting box depth: 47mm
- Neon indicators



Code	Size	Finish
SF8331NBC	Single	Brushed Chrome
SF8331NMW	Single	Matt White
SF8331NBN	Single	Black Nickel
SF8331NPC	Single	Polished Chrome
SF8331NMB	Single	Matt Black
SF8331NPB	Single	Polished Brass

Code	Size	Finish
SF8332NBC	Double	Brushed Chrome
SF8332NMW	Double	Matt White
SF8332NBN	Double	Black Nickel
SF8332NPC	Double	Polished Chrome
SF8332NMB	Double	Matt Black
SF8332NPB	Double	Polished Brass

45A COOKER SWITCH AND SOCKET WITH NEONS

- Double pole switches
- 13A switched socket
- Minimum mounting box depth: 47mm



Code	Finish	Insert
SFR8333NBC	Brushed Chrome	Black
SFR8333NBCG	Brushed Chrome	Grey
SFR8333NBCW	Brushed Chrome	White
SFR8333NMW	Matt White	White
SFR8333NBN	Black Nickel	Black
SFR8333NPC	Polished Chrome	Black

Code	Finish	Insert
SFR8333NPCG	Polished Chrome	Grey
SFR8333NPCW	Polished Chrome	White
SFR8333NMB	Matt Black (Chrome Rocker)	Black
SFR8333NMBB	Matt Black	Black
SFR8333NPB	Polished Brass	Black
SFR8333NPBW	Polished Brass	White



TELEPHONE SOCKETS

- Minimum mounting box depth: 25mm



Code	Model	Finish
SF7300BC	Master	Brushed Chrome
SF7300MW	Master	Matt White
SF7300BN	Master	Black Nickel
SF7300PC	Master	Polished Chrome
SF7300MB	Master	Matt Black (Chrome Shutter)
SF7300PB	Master	Polished Brass

Code	Model	Finish
SF7400BC	Extension	Brushed Chrome
SF7400MW	Extension	Matt White
SF7400BN	Extension	Black Nickel
SF7400PC	Extension	Polished Chrome
SF7400MB	Extension	Matt Black (Chrome Shutter)
SF7400PB	Extension	Polished Brass

NETWORK OUTLETS

- UTP CAT5e
- Minimum mounting box depth: 35mm



Code	Model	Finish
SFRJ45BC	RJ45	Brushed Chrome
SFRJ45MW	RJ45	Matt White
SFRJ45BN	RJ45	Black Nickel
SFRJ45PC	RJ45	Polished Chrome
SFRJ45MB	RJ45	Matt Black (Chrome Shutter)
SFRJ45PB	RJ45	Polished Brass

TV OUTLET

- Minimum mounting box depth: 25mm



Code	Model	Finish
SF0100BC	Non-isolated	Brushed Chrome
SF0100MW	Non-isolated	Matt White
SF0100BN	Non-isolated	Black Nickel
SF0100PC	Non-isolated	Polished Chrome
SF0100MB	Non-isolated	Matt Black
SF0100PB	Non-isolated	Polished Brass

SAT TV OUTLET

- Minimum mounting box depth: 25mm



Code	Model	Finish
SF0150BC	Non-isolated	Brushed Chrome
SF0150MW	Non-isolated	Matt White
SF0150BN	Non-isolated	Black Nickel
SF0150PC	Non-isolated	Polished Chrome
SF0150MB	Non-isolated	Matt Black
SF0150PB	Non-isolated	Polished Brass

BLANKING PLATES



Code	Size	Finish
SF8350BC	1G	Brushed Chrome
SF8350MW	1G	Matt White
SF8350BN	1G	Black Nickel
SF8350PC	1G	Polished Chrome
SF8350MB	1G	Matt Black
SF8350PB	1G	Polished Brass

TV AND SAT TV OUTLET

- Minimum mounting box depth: 25mm



Code	Model	Finish
SF0140BC	Isolated	Brushed Chrome
SF0140MW	Isolated	Matt White
SF0140BN	Isolated	Black Nickel
SF0140PC	Isolated	Polished Chrome
SF0140MB	Isolated	Matt Black
SF0140PB	Isolated	Polished Brass

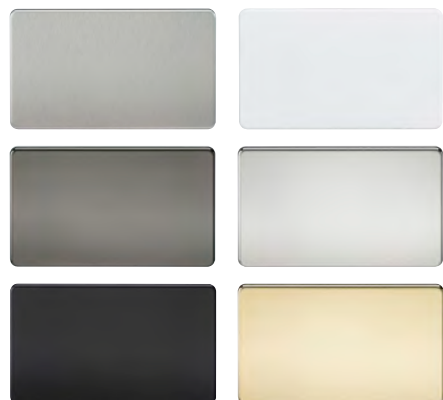

Code	Size	Finish
SF8360BC	2G	Brushed Chrome
SF8360MW	2G	Matt White
SF8360BN	2G	Black Nickel
SF8360PC	2G	Polished Chrome
SF8360MB	2G	Matt Black
SF8360PB	2G	Polished Brass



MODULAR FRAMES

- For use with 25mm x 50mm and/or 50mm x 50mm euro modules



Code	Model	Finish
SF1GBC	1 Module	Brushed Chrome
SF1GMW	1 Module	Matt White
SF1GBN	1 Module	Black Nickel
SF1GPC	1 Module	Polished Chrome
SF1GMB	1 Module	Matt Black
SF1GPB	1 Module	Polished Brass



Code	Model	Finish
SF4GBC	2-4 Modules	Brushed Chrome
SF4GMW	2-4 Modules	Matt White
SF4GBN	2-4 Modules	Black Nickel
SF4GPC	2-4 Modules	Polished Chrome
SF4GMB	2-4 Modules	Matt Black
SF4GPB	2-4 Modules	Polished Brass



Code	Model	Finish
SF2GBC	1-2 Modules	Brushed Chrome
SF2GMW	1-2 Modules	Matt White
SF2GBN	1-2 Modules	Black Nickel
SF2GPC	1-2 Modules	Polished Chrome
SF2GMB	1-2 Modules	Matt Black
SF2GPB	1-2 Modules	Polished Brass

Modular Inserts available on Page 143

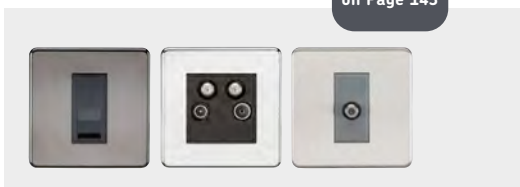

ELECTRICAL SCREWS

- Flat-head / Slotted
- Countersunk



Code	Model	Qty
C-SCREW50N	50mm Nickel	100



GRID MOUNTING FRAMES



Code	Size
GDS001F	1-2G
GDS002F	3-4G
GDS003F	6-8G
GDS004F	9-12G

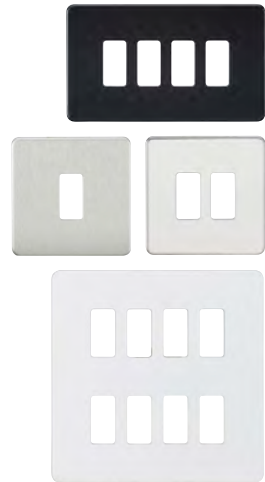

GRID FACEPLATES

To indicate preferred finish, replace xx on code with BC (Brushed Chrome), PC (Polished Chrome), MW (Matt White) or MB (Matt Black)

Code	Size
GDSF001xx	1G
GDSF002xx	2G
GDSF003xx	3G
GDSF004xx	4G
GDSF006xx	6G
GDSF008xx	8G
GDSF009xx	9G (BC, PC, and MW only)
GDSF012xx	12G (BC, PC, and MW only)



STEEL BACK BOXES

- 35mm deep
- Fixed and adjustable mounting lugs
- Galvanized steel construction 1mm thickness (+/- 1%)
- Earth terminals
- Mix of 20mm and 25mm knockout positions

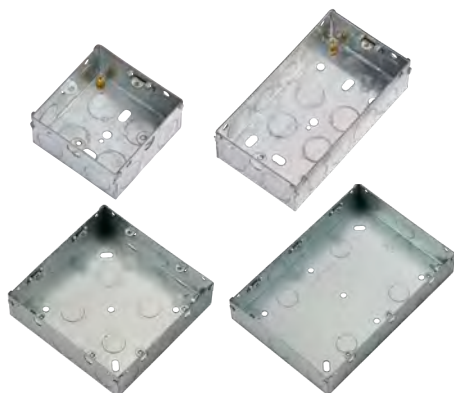

Code	Size
GSK35	1-2G
GSK235	3-4G
GDSG68G	6-8G
GDSG912G	9-12G

To indicate preferred finish, replace xx on code with BC (Brushed Chrome), PC (Polished Chrome), MW (Matt White), or MB (Matt Black)

10A GRID FAN ISOLATOR MODULES

- Triple pole
- Requires single grid position only



Code	Model
GDM020xx	Fan Isolator Switch Module
GDM021xx	Fan Isolator Key Switch Module (supplied with test key)

20AX GRID KEY SWITCH MODULES

- Supplied with test key



Code	Model
GDM007xx	2-Way SP (marked "EMG LTG TEST")
GDM008xx	DP (marked "EMG LTG TEST")
GDM009xx	2-Way SP
GDM010xx	DP
GDKEY	Spare Key

20AX GRID SWITCH MODULES



Code	Model
GDM001xx	2-Way SP
GDM002xx	DP
GDM003xx	DP + LED Indicator
GDM004xx	2-Way SP (centre-off)
GDM005xx	Intermediate*
GDM006xx	2-Way SP Retractive (marked "PRESS")

*2G intermediate switches can be made using GDM005xx

GRID TRAILING-EDGE DIMMER MODULES

- 10-200W Incandescent | 10-100W LED



Code	Model
GDM014xx	1-Way Trailing-Edge Dimmer (Press)
GDM200xx	2-Way Trailing-Edge Dimmer (Rotary)

To indicate preferred finish, replace xx on code with BC (Brushed Chrome), PC (Polished Chrome), MW (Matt White), or MB (Matt Black)

GRID DUMMY DIMMER MODULE

- Push on/off function only
- Ideal for situations where you require one position to look like a dimmer but act like a switch



Code	Model
GDM022xx	6A 2-Way

MISCELLANEOUS GRID MODULES



Code	Model
GDM011xx	Fuse Holder (13A)
GDM012xx	Flex Outlet (max. 10mm)
GDM013xx	Blank
GDM017	Indicator - Green
GDM018	Indicator - Red
GDM019	Indicator - Orange

GRID DUAL USB CHARGER MODULE

- Requires two grid positions



Code	Model
GDM016xx	Dual USB Charger Module

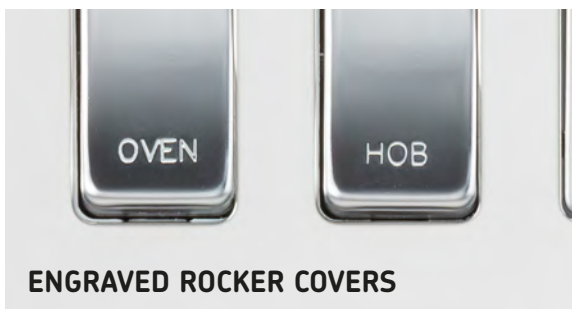

ENGRAVED ROCKER COVERS

GRID ROCKER COVERS

- Easy to install
- Replace an existing rocker with an engraved version indicating the appliance it refers to



Code	Model
GDBOILxx	Boiler
GDDISHxx	Dishwasher
GDFANxx	Fan
GDWASHxx	Washing Machine
GDDRYxx	Tumble Dryer
GDCOOKxx	Cooker Hood
GDHOBxx	Hob
GDOVENxx	Oven
GDMICROxx	Microwave
GDFRIDxx	Fridge Freezer



Knightsbridge -

CHARGING RATE	DESCRIPTION	USE WITH	BEST CABLE CHOICE
WIRELESS	Supplying 5V DC 1A wirelessly via induction	Phones that support Wireless charging e.g. those that are Qi compatible	Not required
2.1A SHARED	Supplying up to 5V DC 2.1A across both ports	All phone types	Certified USB Cable, MFI licenced Apple Cable
2.4A SHARED	Supplying up to 5V DC 2.4A across both ports	All phone types	
3.1A SHARED	Supplying up to 5V DC 3.1A across both ports	All phone types	
5.1A SHARED	Supplying up to 5V DC 5.1A across 4 ports	All phone types	Certified USB Cable, MFI licenced Apple Cable
FASTCHARGE Type-A	Supplying up to 5V DC 2A - up to 10W (standard mode) 9V DC 2A - up to 18W (FASTCHARGE mode) 12V DC 1.5A - up to 18W (FASTCHARGE mode). The ports offers up to 5V DC 2A when FASTCHARGE is not activated. When FASTCHARGE is activated the Type A port will output at 5V DC 1A	All phone types - but if your phone supports QC3.0 or USB-PD then it will enjoy the FASTCHARGE benefits	For optimum charge rates we recommend a certified USB Type-A to Type-C cable to enjoy FASTCHARGE
FASTCHARGE Type-C	Supplying up to 5V DC 3A - up to 15W (FASTCHARGE mode) 9V DC 2A - up to 18W (FASTCHARGE mode) 12V DC 1.5A - up to 18W (FASTCHARGE mode). The ports offers up to 5V DC 2A when FASTCHARGE is not activated. When FASTCHARGE is activated the alternative port will output at 5V DC 1A		For optimum charge rates we recommend a certified USB Type-C to Type-C cable to enjoy FASTCHARGE

These USB chargers are designed for devices that require no more than 20W of power. They are not suitable for laptops or some of the high-power tablets. Whilst Apple portable devices will charge on any of the above models, they do not currently support QC3.0 or USB-PD, they rely on their own proprietary charging technique and will therefore decide the optimum charge for themselves.

LEADING THE CHARGE!

BEST USED FOR

PRODUCT

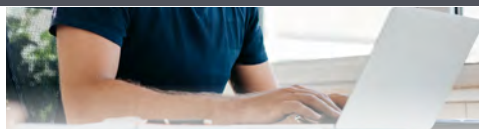

DESKTOPS / BEDSIDE CABINETS

A modern and convenient option. Place your phone on the charging device whilst sleeping or working for a steady sustained charge over a longer period of time



OFFICE / HOME OFFICE / LIVING ROOM / BEDROOM / AND KITCHEN

Ideal for general areas where the convenience of a charging point would be useful



BIG HOUSEHOLDS / AIRPORT HOSPITALITY SUITES

Perfect for multiple users, or if you have multiple devices



CITY-CENTRE COFFEE SHOPS AND CAFES

FASTCHARGE is the perfect charging solution for busy locations with people on-the-go. With a compatible phone, a consumer can achieve 0-50% charge in approx. 30mins - just enough time to enjoy a coffee!



It is the phone or devices that decides the optimum charge rate and once a device reaches around 80% charge, they slow the charge rate down and features like FASTCHARGE will not activate.

Using sub-standard or uncertified USB charging cables can prevent you obtaining the optimum charging rates for your device. We recommend using certified USB cables only



SPECIALIST SOCKETS

Our specialist socket range offers convenient under cabinet, desktop, and worktop power solutions for kitchens and office spaces

13A Dual Fitting Sockets	108
Vertical Corner Mount Sockets / Pop-up Sockets	109
13A Dual Fitting Power Station / 13A Surface Mount Sockets / Pop-up Dual USB Charger	110
Pop-up Wireless Dual USB Charger / Desk Mount USB Charger / 13A Recess Mount Switched Socket	111
Connectors / Cable Gland	137



13A DUAL FITTING SOCKETS

- Ideal for kitchens, bedrooms, utility rooms, and hotel rooms
- Matching metal rocker switches
- Also suitable for mounting on counter tops against walls
- Stainless steel finish



SKR008



SKR009A



SKR0014

Code	Model	Height	Width	Projection	Insert
SKR008	2G DP	77mm	212mm	77mm	Grey
SKR009A	2G + Dual USB Charger	77mm	212mm	77mm	Grey
SKR0014	1G + Dual USB Charger + 3W RMS Bluetooth Speaker	79.5mm	212mm	79.5mm	Grey
SKR002A	2G + Dual USB Charger	93mm	93mm	Black	



SKR002A

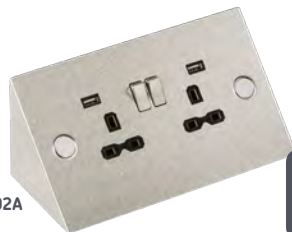

13A VERTICAL CORNER MOUNT SOCKETS

- The perfect solution for unused corners on kitchen counter tops, in bedrooms, and hotel rooms



Code	Model	Height	Width	Projection	Insert
SKR001A	2G with Removable Phone Holder + Dual USB Charger	236mm	110mm	67mm	Black
SKR0013	1G with Built-in 3W RMS Bluetooth Speaker + Dual USB Charger	236mm	112mm	74mm	Grey

IP54 POP-UP SOCKETS

- IP54* rated pop-up sockets for use in kitchen counter tops, offices, boardrooms, and hotel rooms
- Ideal wherever a discreet power solution is required
- These devices have a secure clip that locks the unit upright when in use
- Unit can be closed with items plugged in via the innovative cable management cap and inverted socket positions
- Fitted with approx. 2m cable and BS plug top
- Requires a 90mm-92mm circular cut-out with a min. 25mm clearance around the hole
- Mounting surface thickness 10mm to 50mm
*only when closed



Code	Model
SK006	3G
SK005A	2G + Dual USB Charger + Bluetooth Speaker





13A 2G DUAL FITTING POWER STATION

- Power, USB charging, Bluetooth speaker system and a removable tray
- Also suitable for mounting on counter tops against walls
- Back-lit fused ON/OFF rocker switch
- Built-in 2W RMS Bluetooth Speaker
- Fitted with approx. 2m cable and BS plug top
- Optional hanging tray to support phones, tablets or cookbooks

Code	Model
SK007	2G Power Station



13A SURFACE MOUNT SOCKETS

- Surface mounted power solutions - ideal for kitchens, bedrooms, offices, and hotels
- Fitted with approx. 2m cable (open ended)
- Back-lit fused ON/OFF rocker switch
- Requires an 18mm to 20mm circular cut-out
- Mounting surface thickness 14mm to 30mm

Code	Model
SK0011	2G with Dual USB Charger
SK004	2G + Speaker with Dual USB Charger

POP-UP DUAL USB CHARGER

- Compact pop-up USB charging solution
- Recess mounts into desk and work surfaces, includes plug-in power supply
- Ideal for workstations, office / home office, and installation into suitable furniture to create a bespoke charging point
- Pop-up action - push to pop up and push to close
- Requires a 44mm circular cut-out
- Minimum mounting surface thickness of 10mm

Code	Model
SK0010	Pop-Up Dual USB Charger



POP-UP WIRELESS DUAL USB CHARGER

- Conveniently charge your compatible phone wirelessly by simply placing on the top pad, or pop up the dual USB socket and fast charge your device via the Type-C USB port
- Wireless charging - effective charging distance: 2-5mm (compatible with Qi wireless charging)
Charging rate DC 5V / 1A
- 1 x Type-A (DC 5V max. 2A)
- 1 x Type-C (DC 5V to 12V max. 3.1A compatible with QC3.0 and PD fast charge)
- Total output: max. 4A when being shared
- Includes plug-in power supply



Code	Model	
SK0015	Wireless Desktop Charger with Pop-up Dual USB Charger	NEW



DESK MOUNT USB CHARGER

- 2 x adapters included for existing desk cut-outs
- Dual USB 5V DC 4A (shared)
- Type-A and Type-C USB
- Cable management facility
- Includes plug-in power supply
- 60mm or 80mm cut-out required

Code	Model	
SK0012	Desk Mount USB Charger	NEW



13A RECESS MOUNT SWITCHED SOCKET

- Provides a protected recess mounted switched socket with USB charging
- Stainless steel lid (not spring loaded)
- Fitted with approx. 2m cable and BS plug top
- Requires a 112mm circular cut-out
- Mounting surface thickness 14mm to 50mm

Code	Model	
SKR003A	Recess mount socket with dual usb charger	





METAL CLAD

Our heavy duty range of switches and sockets finished in a durable powder-coated metal clad finish

13A Sockets / Sockets with USB / Fan Isolator Switch / 10AX Switches / Fused Spur Units / 20A Switches	115
Cooker Switches and Sockets / Media Outlets / Blanking Plates / Modular Frames	116
Grid Wiring Accessories	117-119



DOUBLE POLE SWITCHES

On selected products, for additional safety

COLOUR MATCHING BACK BOX



Single plate size:
82mm x 82mm

Double plate size:
82mm x 142mm

Projection:
45mm
(unless otherwise stated)

EASY CABLING

Multiple cable access points

DURABLE

Powder-coated surface



QUALITY USB

High quality US IC's and USB controllers on USB products



HIGH INTEGRITY EARTHING

Twin earthing terminals (on double switched sockets), for compliance with BS 7671:2008 regulation 543-7

15

YEAR WARRANTY*

*2 YEARS ON ELECTRONIC PRODUCTS



13A SOCKETS

Code	Size	Model
MR7000	1G	DP Switched Socket
MR7000U	1G	Unswitched Socket
MR9000	2G	DP Switched Socket + Twin Earth
MR9000U	2G	Unswitched Socket + Twin Earth



13A SOCKETS WITH USB

Code	Size	Model
MR9124	1G	Switched Socket with Dual USB Charger
MR9224	2G	Switched Socket with Dual USB Charger + Twin Earth



GRID FAN ISOLATOR
MODULES PAGE 118

10AX FAN ISOLATOR SWITCH

Code	Model
M1100	Triple Pole



10AX SWITCHES

Code	Size	Model
M1200	1G	Intermediate
M2000	1G	2-Way
M3000	2G	2-Way
M4000	3G	2-Way



FUSED SPUR UNITS

- Double pole switches where applicable

Code	Model
M6000	Unswitched
M6000N	Unswitched + Neon
M6300	Switched
M6300N	Switched + Neon
M6300F	Switched + Flex Outlet (front)



20A SWITCHES

- Double pole Switches

Code	Model
M8341	Switched
M8341N	Switched + Neon



45A COOKER SWITCHES

- Double pole switches

Code	Size	Model
M8331N	Single	Switched + Neon
M8332N	Double	Switched + Neon



BLANKING PLATES

- Backbox not included

Code	Size
M8500	1G
M8600	2G



45A COOKER SWITCH AND SOCKET

- Double pole switches
- 13A switched socket

Code	Model
MR8333N	Switched + Neon



MODULAR FRAMES

- Backbox not included

Code	Size
M1G	1 Module
M2G	1-2 Modules
M4G	3-4 Modules



MEDIA OUTLETS

Code	Model
M7300	Telephone Socket - Master
M7400	Telephone Socket - Extension
MRJ45	Network Outlet - RJ45



Modular solutions available
on page 122-125



GRID FACEPLATES

- Requires grid mounting frame (sold separately)
- For use with Knightsbridge Grid accessories only



Code	Size
GDFP001M	1G
GDFP002M	2G
GDFP003M	3G
GDFP004M	4G

Code	Size
GDFP006M	6G
GDFP008M	8G
GDFP009M	9G
GDFP0012M	12G



GRID MOUNTING FRAMES

Code	Size
GDF001F	1-2G
GDF002F	3-4G



DURABLE POWDER COATED GRID BACK BOXES

- 44mm deep
- Fixed mounting lugs
- With earth terminals
- Mix of 20mm knockout positions

Code	Size	
M8700	1-2G	1 x Earth Terminal
M8900	3-4G	1 x Earth Terminal
GDSG68M	6-8G	2 x Earth Terminals
GDSG912M	9-12G	2 x Earth Terminals



20AX GRID SWITCH MODULES

Code	Model
GDM001U	2-Way SP
GDM002U	DP
GDM003U	DP + LED Indicator
GDM004U	2-Way SP (centre-off)
GDM005U	Intermediate
GDM006U	2-Way SP Retractive (marked "PRESS")



10A GRID FAN ISOLATOR MODULES

- Triple pole
- Requires one grid position only

Code	Model
GDM020U	Grid fan isolator switch module
GDM021U	Grid fan isolator key switch module (supplied with test key)



20AX GRID KEY SWITCH MODULES

Code	Model
GDM007U	2-Way SP (marked "EMG LTG TEST")
GDM008U	DP (marked "EMG LTG TEST")
GDM009U	2-Way SP
GDM010U	DP
GDKEY	Spare Key



GRID TRAILING-EDGE DIMMER MODULES

- 10-200W incandescent | 10-100W LED

Code	Model
GDM014U	1-Way Trailing-Edge Grid Press Dimmer
GDM200U	2-Way Trailing-Edge Grid Rotary Dimmer



GRID DUAL USB CHARGER MODULE

- Requires two grid positions

Code	Model
GDM016U	Dual USB Charger Module



GRID DUMMY DIMMER MODULE

- Push on/off function only
- Ideal for situations where you require one position to look like a dimmer but act like a switch

Code	Model
GDM022U	6A 2-Way



MISCELLANEOUS GRID MODULES

Code	Model
GDM011U	Fuse Holder (13A)
GDM012U	Flex Outlet (max. 10mm)
GDM013U	Blank
GDM017	Indicator - Green
GDM018	Indicator - Red
GDM019	Indicator - Orange



GRID ROCKER COVERS

- Easy to install
- Replace an existing rocker with an laser or pad printed version indicating the appliance it refers to

Code	Model
GDBOILU	Boiler
GDDISHU	Dishwasher
GDFANU	Fan
GDWASHU	Washing Machine
GDDRYU	Tumble Dryer

Code	Model
GDCOOKU	Cooker Hood
GDHOB	Hob
GDOVENU	Oven
GDMICROU	Microwave
GDFRIDU	Fridge Freezer



DATACOMMS

A comprehensive range of datacomms accessories. Our selection of black, white and grey inserts can be used alongside our entire offering of switches and sockets

Telecom Modules	122
TV Modules	122-123
HDMI Modules / Brush Modules / HDMI Cables	124
USB Modules / 13A Socket Modules / Round Pin Socket Modules / Blank Modules	125
Network Cables / Network Patch / Panels / Network Accessories	126

FOR MODULAR FRAMES PLEASE SEE:

- Moulded - Square Edge Page 11
- Moulded - Curved Edge Page 18
- Raised Edge - Rounded Page 33
- Raised Edge - Square Page 48
- Flat Plate Page 71
- Screwless Page 100
- Metal Clad Page 116



TELECOM MODULES

- 25mm x 50mm modules
- IDC Termination

Code	Model	Finish
NETBTMWH	Master	White
NETBTMGY	Master	Grey
NETBTMBK	Master	Black
NETBTSWH	Extension	White
NETBTSGY	Extension	Grey
NETBTSBK	Extension	Black
NETRJ11WH	RJ11	White
NETRJ11GY	RJ11	Grey

Code	Model	Finish
NETRJ11BK	RJ11	Black
NETCAT5WH	UTP CAT5e RJ45	White
NETCAT5GY	UTP CAT5e RJ45	Grey
NETCAT5BK	UTP CAT5e RJ45	Black
NETCAT6WH	UTP CAT6 RJ45	White
NETCAT6GY	UTP CAT6 RJ45	Grey
NETCAT6BK	UTP CAT6 RJ45	Black



COAX TV MODULES

- Clamp-on PCB type connection
- 25mm x 50mm modules
- Coax socket

Code	Finish
NETTVWH	White
NETTVGY	Grey
NETTVBK	Black

SAT TV MODULES

- 25mm x 50mm modules
- F-Type coupler connection

Code	Finish
NETSATWH	White
NETSATGY	Grey
NETSATBK	Black



SCREENED COAX TV MODULES

- 25mm x 50mm modules
- Coax socket

Code	Finish
NETTVSWH	White
NETTVSGY	Grey
NETTVSBK	Black



SCREENED SAT TV MODULES

- 25mm x 50mm modules
- F-type connection

Code	Finish
NETSATSWH	White
NETSATSGY	Grey
NETSATSBK	Black

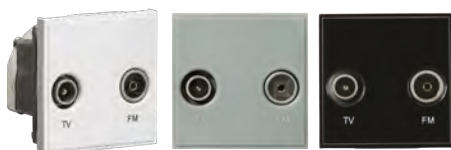

SCREENED DIPLEX TV / FM DAB MODULES

- 50mm x 50mm modules
- Coax plug / coax socket

Code	Finish
NETDITVWH	White
NETDITVGY	Grey
NETDITVBK	Black



SCREENED DIPLEX TV / SAT TV MODULES

- 50mm x 50mm modules
- Coax plug / F-type connection

Code	Finish
NETDISATWH	White
NETDISATGY	Grey
NETDISATBK	Black



SCREENED TRIPLEX TV / FM DAB / SAT TV MODULES

- 50mm x 50mm modules
- Coax plug / coax socket / F-type Connection

Code	Finish
NETTRIWH	White
NETTRIGY	Grey
NETTRIBK	Black



SCREENED QUADPLEX TV / FM DAB / SAT1 / SAT2 MODULES

- 50mm x 50mm modules
- Coax plug / Coax socket / 2 x F-type connections

Code	Finish
NETQDWH	White
NETQDGY	Grey
NETQDBK	Black



MULTIMEDIA PLATE PAGE 15



HDMI MODULES

- 25mm x 50mm Modules
- HDMI socket on 100mm cable for easy cable management
- HDMI socket-to-socket connection

Code	Finish
NETHDMIWH	White
NETHDMIGY	Grey
NETHDMIBK	Black



BRUSH MODULES

- Facilitates a tidy cable entry/exit from wall
- Use in conjunction with any of our modular faceplates to create a brush outlet faceplate

Code	Size	Finish
NETBR1GW	25mm x 50mm	White
NETBR1GGY	25mm x 50mm	Grey
NETBR1G	25mm x 50mm	Black
NETBR2GW	50mm x 50mm	White
NETBR2GGY	50mm x 50mm	Grey
NETBR2G	50mm x 50mm	Black
NETBR4GW	100mm x 50mm	White
NETBR4GGY	100mm x 50mm	Grey
NETBR4G	100mm x 50mm	Black

NB: Not intended for use alongside power sockets / modules in same channel due to potential hazardous voltage that may be present and easily reached



HDMI CABLES

- Support full HD 1080P | 4K-ready (where stated)
- Supports ARC (Audio Return Channel)
- Gold plated connectors
- Durable over-moulded connectors with nylon braided cable

Code	Model
AV2	2m (4K-Ready)
AV8*	3m (4K-Ready)
AV6	5m
AV7	10m

*AV8 includes a HDMI to Mini HDMI and Micro HDMI Adaptor



ASSEMBLED BRUSH MODULE FACEPLATES

Code	Size
NETBRUSH2G	Single Plate Assembled
NETBRUSH4G	Twin Plate Assembled



DUAL USB CHARGER MODULES

- 50mm x 50mm Modules
- 5V DC 2A (shared)



Code	Finish
NETUSBWH	White
NETUSBGY	Grey
NETUSBBK	Black

5A ROUND PIN SOCKET MODULES

- Unswitched
- 50mm x 50mm Modules

Code	Finish	
NET5AWH	White	NEW
NET5AGY	Grey	NEW
NET5ABK	Black	NEW



DUAL USB CHARGER MODULES (TYPE-A/TYPE-C)

- 25mm x 50mm Modules
- 1 x Type-A and 1 x Type-C
- 5V DC 3.1A (shared)



Code	Finish
NETUSBCWH	White
NETUSBCGY	Grey
NETUSBCBK	Black



QUARTER BLANK MODULES

- 12.5mm x 50mm Modules
- Supplied in packs of 10

Code	Finish
NETQWH	White
NETQGY	Grey
NETQBK	Black



13A SOCKET MODULES

- Unswitched
- 50mm x 50mm Modules

Code	Finish
NET13WH	White
NET13GY	Grey
NET13BK	Black



HALF BLANK MODULES

- 25mm x 50mm Modules
- Supplied in packs of 10

Code	Finish
NETHWH	White
NETHGY	Grey
NETHBK	Black

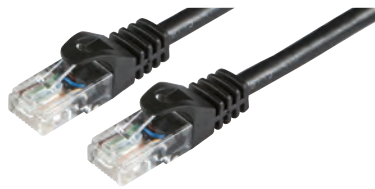

NETWORK CABLES

- CCA 24AWG
- RJ45 to RJ45 snagless boots

Code	Model	Finish
NETC51M	1m - UTP CAT5e	Grey
NETC53M	3m - UTP CAT5e	Grey
NETC55M	5m - UTP CAT5e	Grey
NETC510M	10m - UTP CAT5e	Grey

Code	Model	Finish
NETC61M	1m - UTP CAT6	Black
NETC63M	3m - UTP CAT6	Black
NETC65M	5m - UTP CAT6	Black
NETC610M	10m - UTP CAT6	Black



NETWORK PATCH PANELS

- 19" 1U 24-port
- Universal / 110 IDC termination
- Port identification
- Dual 568A/B

Code	Model
NET24C5E	UTP CAT5e
NET24C6	UTP CAT6



NETWORK ACCESSORIES

Code	Size	Model
NETC5CP	RJ45 Coupler	UTP CAT5e
NETC6CP	RJ45 Coupler	UTP CAT6
SM314	Junction Box	UTP CAT5e
SM315	Junction Box	UTP CAT6



REMOTE
CABLE TESTER
PAGE 150

SERVICE



ALL CALLS ANSWERED
IN 3 RINGS OR LESS



SAME DAY COLLECTION
FROM OUR WAREHOUSE



QUOTES WITHIN
1 HOUR



DELIVER DIRECT TO
YOUR CUSTOMERS
WITH K-DIRECT



5PM CUT OFF NEXT DAY
DELIVERY (MON-THU)
(3PM ON FRIDAYS)



ORDER TRACKING
AVAILABLE





GRID WIRING ACCESSORIES

IDEAL FOR THE MOST DEMANDING PROJECTS

Grid wiring accessories offer multiple switching options, control, and additional features such as USB charging.

With solutions available across multiple ranges, our grid offering is versatile and offers a perfect solution for domestic, industrial, and commercial installations.

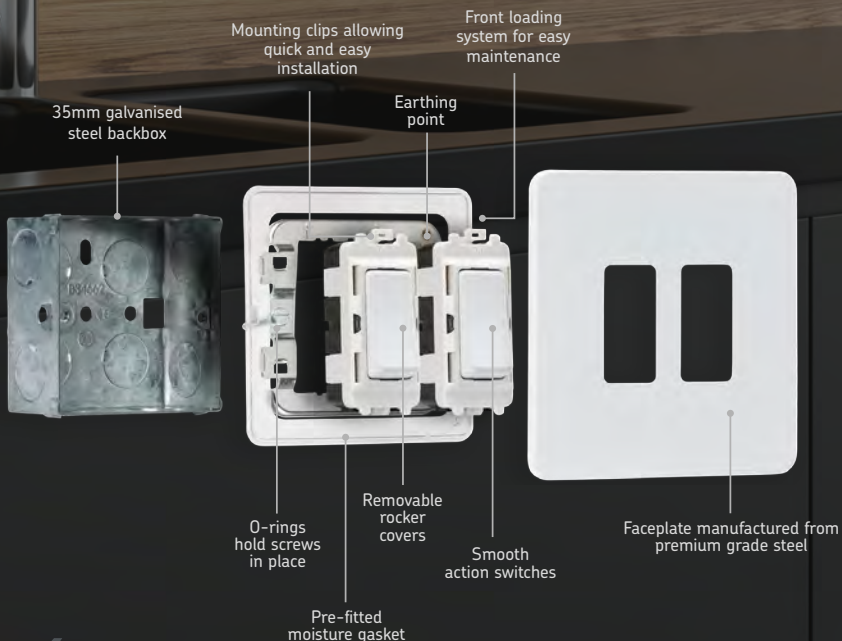

Manufactured to the latest British Safety Standards

Example shown here is for Screwless grid accessories, construction on other ranges may vary



ACCESSORIES



CURVED EDGE



PAGES
19-21

ROUNDED EDGE



PAGES
34-35

Available in: Brushed Chrome
and Polished Chrome

SQUARE EDGE



PAGES
49-51

Available in: Brushed Chrome

FLAT PLATE



PAGES
72-74

Available in: Brushed Chrome
and Polished Chrome

SCREWLESS



PAGES
101-103

Available in: Brushed / Polished
Chrome, Matt White and Matt Black

METAL CLAD



PAGES
117-119



WEATHERPROOF

Outdoor wiring accessories, providing everything you need to bring power to domestic and commercial outdoor spaces

13A Outdoor Sockets / Fused Spur Units / Outdoor Socket Kit	133
20AX Outdoor Light Switches	134
Outdoor Control Boxes / RF Remote Controlled / RCD Protected Socket / Smart Wi-fi Control Box	135
Outdoor Enclosures / Weatherproof Boxes	136
Connectors / Cable Gland	137



Multiple 20mm
cable access points

Power indicator

Rugged, impact resistant
polycarbonate construction

Transparent casing.
Lid holds open when
required for ease of use

Padlock ready,
securable lid

IP66 Protected from solid objects
including dust and powerful jets of
water from all directions

IP66

IK06 Protected against 1 joule impact.
Equivalent to the impact of a 0.25 kg mass
being dropped from 400mm above item

IK06

- Rugged, impact resistant polycarbonate construction
- Double pole switches where stated
- Large-sized locking mechanism for ease of use
- Transparent casing allowing on/off power indicators to be seen at a distance, and offers extra clearance for the more robust fully moulded plug tops
- Lockable lid (padlock not included)
- Multiple 20mm cable access points (sides and rear)

IP66

IK06



13A OUTDOOR SOCKETS

Code	Size	Model	
OP7N	1G	DP + Indicator (Twin Earth)	NEW
OP9N	2G	DP + Indicator (Twin Earth)	NEW



FUSED SPUR UNITS

Code	Model	
OP63N	Switched + Indicator	NEW
OP6N	Unswitched + Indicator	NEW

OUTDOOR SOCKET KIT

- 2G Outdoor Socket
- RCD Plug
- 3m Rubber Outdoor Cable

Code	Size	Model	
OPRCDKIT	2G	Outdoor Socket Kit + RCD Plug	NEW

Kit supplied unassembled



ARRIVING
Q4 2020

IP66 2G SMART OUTDOOR SWITCHED SOCKET

- Controls up to 2 outdoor appliances
- Manually override by using the switch on the socket
- Rugged outdoor enclosure
- Range: 20m-40m (depending on Wi-Fi signal coverage)

Code	Model	
OP9KW	IP66 2G Outdoor Switched Socket	NEW



ARRIVING
Q4 2020

See Page 165
for more info on Smart



Rugged, impact resistant polycarbonate construction

Built-in blue LED indicator

20AX switches

Unique circular rocker switch design

Multiple 20mm cable access points



20AX OUTDOOR LIGHT SWITCHES

Code	Model	
OP2	1G 2-Way with Indicator	NEW
OP3	2G 2-Way with Indicator	NEW
OP21	1G Retractive with Indicator	NEW

IP66

IK06

OUTDOOR CONTROL BOXES

- Manual and RF remote control boxes
- Rugged and impact resistant polycarbonate construction
- Multiple 20mm cable access points
- Range of up to 20m on wireless models (dependent on environment)

IP66

MANUAL

Code	Load	Model
IP3G	13A	3G Control Box
IP5G	13A	5G Control Box

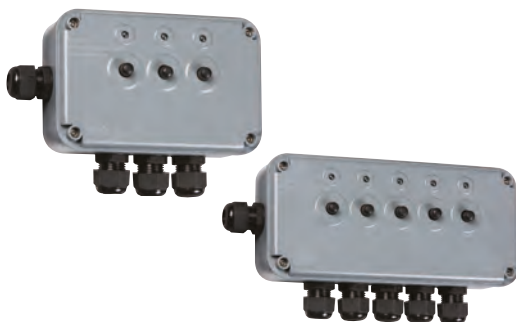

RF REMOTE CONTROLLED

Code	Load	Model
IP663G	13A	3G Control Box + Remote
IP665G	13A	5G Control Box + Remote
IPREMOTE		Spare Remote Control* NEW
IP9000R	13A	2G Socket + Remote

* For use with IP663G and IP665G only

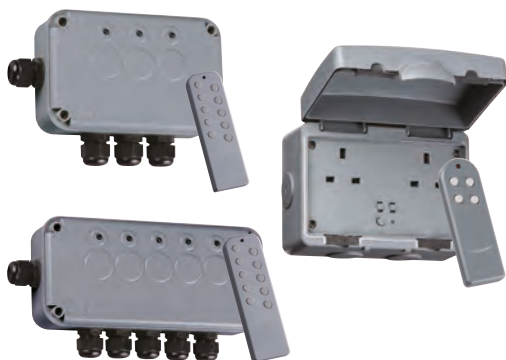

RCD PROTECTED SOCKET

- RCD trip current of 30mA
- RCD trip speed of <30ms

Code	Load	Size	Model
IPRCD	13A	2G	RCD Switched Socket





OUTDOOR ENCLOSURES

- Rugged, impact resistant polycarbonate construction
- Multiple 20mm cable access points
- Designed for use up to 230V 50Hz

IP66

IK06



Code	Height	Width	Projection	Model
JB007	86mm	74mm	62mm	Grey
JB008	86mm	125mm	62mm	Grey
JB009	111mm	181mm	100mm	Grey
JB0010	184mm	274mm	135mm	Grey

Code	Height	Width	Projection	Model
JB007BK	86mm	74mm	62mm	Black NEW
JB008BK	86mm	125mm	62mm	Black NEW
JB009BK	111mm	181mm	100mm	Black NEW
JB0010BK	184mm	274mm	135mm	Black NEW

WEATHERPROOF BOXES

Ideal for creating bespoke outdoor wiring requirements, for outdoor seasonal lighting, and general outdoor power requirements

IP55

IK06

- 5 channel gasket allows 1 x power in and 4 x power out, ideal for use with a 4G trailing socket
- Wall mountable via rear mounting plate
- Velcro mounting pad included with velcro tape
- Screwless design, easy to open and close

Code	Height	Width	Projection	Model
JB55	334mm	220mm	116mm	Grey NEW
JB55BK	334mm	220mm	116mm	Black NEW





WEATHERPROOF CONNECTORS

- IP68 rated
- 450V 16A
- 3 pole
- For use with H07RNF 3G 0.75mm² to 4.0mm² cable

IP68



Code	Depth	Cable Diameter	Model
JB002	5bar	Min. 5mm / Max. 14mm	Inline Connector
JB003	2bar	Min. 5mm / Max. 14mm	3-Way Connector
JB004	2bar	Min. 5mm / Max. 10mm	3-Way Connector box
JB0011	2bar	Min. 5mm / Max. 12mm	Plug & Socket Connector

IP66 CABLE GLAND FOR USE WITH OUTDOOR SWITCHES, SOCKETS, AND ENCLOSURES

IP66

Code	Size	Qty
JB006	M20 (20mm)	10





KNOW YOUR IP RATING

IPxx

First digit

Indicates the level of protection against access to hazardous parts and the ingress of solid objects

1

>50mm

Protection against any large surface of the body, such as the back of a hand, but no protection against deliberate contact

2

>12.5mm

Protection against fingers or similar objects

3

>2.5mm

Protection against tools, thick wires, etc

4

>1mm

Protection against most wires, slender screws, large insects etc

5

Dust protected

Protection against dust that may harm equipment

6

Dust tight

No ingress of dust; complete protection against ingress

Second digit

Indicates the level of protection against the harmful ingress of water

1

Dripping water

Protection against vertical drops when mounted in an upright position onto a turntable and rotated at 1 RPM

2

Dripping water (tilted)

Protection against water droplets when tilted up to 15° from vertical

3

Spraying water

Protection against water spray up to an angle of 60 degrees

4

Splashing water

Protection against splashing water from any direction

5

Water jets

Protection against low pressure jets of water from any direction

6

Powerful water jets

Protection against high pressure jets of water from any direction

Please note, IPX7 and IPX8 are tested using different methods from IPX6 and below. Products with IPX7 or IPX8 ratings are not necessarily protected from water jets or splashes

7

Immersion up to 1m

Protection from immersion in water under defined conditions of pressure and time

8

Immersion beyond 1m

Protection from immersion in water under defined conditions of pressure and time



IP66

See on page 134



Knightsbridge

Committed to a brighter future



At Knightsbridge, we believe in looking after our customers and looking after our planet. This philosophy is important to us and is why we have started to apply it to the way we package and present our products.

We are now working in conjunction with the FSC® moving towards 100% recyclable / 100% recycled packaging solutions. Look out for the FSC® label on our certified packaging.



This is our plan, this is our commitment to a brighter future.



ENVIRONMENTALLY APPROPRIATE forest management ensures that the harvest of timber and non-timber products maintains the forest's biodiversity, productivity, and ecological processes.



SOCIALLY BENEFICIAL forest management helps both local people and society at large to enjoy long term benefits and also provides strong incentives to local people to sustain the forest resources and adhere to long-term management plans.



ECONOMICALLY VIABLE forest management means that forest operations are structured and managed so as to be sufficiently profitable, without generating financial profit at the expense of the forest resource, the ecosystem, or affected communities.



WIRING BASICS

Your everyday electrical essentials including pendant sets, extension leads, tools, testing kits, and more

Dry Lining Boxes / Galvanised Boxes / Grid Back Boxes / Extension Boxes	142
Surface Boxes / Junction Boxes / Service Connector Blocks	143
Pendant Sets / Pull Cord Switches	144-145
Batten Holders / Lamp Holder / Cord Switches / Cord Dimmers / Extension Leads	146
Trailing Sockets / Mains Adaptors / 3-Pin Mains Connectors / RCD Adaptors, Sockets and Fused Spur	147
Plug Tops / Fuses / Strip Connectors / Screws	148
Holesaws	149
Testing Kits / Tools	150



DRY LINING BOXES

- Large flange to prevent slipping into cavity
- Two adjustable lugs
- Cable entry channels top and bottom (except SN8375)
- Cable knockout on rear
- Minimum 7mm plasterboard thickness required



Code	Model	Qty
SN8370	35mm - 1G	10
SN8381	47mm - 1G	10
SN8380	35mm - 2G	10
SN8382	47mm - 2G	10
SN8375	34mm Round	10
SN8380D	35mm Dual	10
SN8335D	35mm 1G + 2G	5

GSK298MM

**ARRIVING
Q4 2020**

GALVANISED STEEL BOXES

- Galvanized steel construction 1mm thickness (+/- 1%)
- One fixed mounting lug and one adjustable mounting lug (except Architrave and Dual Boxes)
- Cable knockouts on all sides (except Architrave and 16mm Boxes)



Code	Model	Qty
GSK27	27mm Architrave + Earth Terminal	20
GSK16	16mm 1G + Earth Terminal	20
GSK25	25mm 1G + Earth Terminal	10
GSK35	35mm 1G + Earth Terminal	10
GSK47	47mm 1G + Earth Terminal	10
GSK225	25mm 2G + Earth Terminal	5
GSK235	35mm 2G + Earth Terminal	5
GSK247	47mm 2G + Earth Terminal	5
GSK235D	35mm Dual + Earth Terminal	5
GSK298MM	47mm 4 x 2G + Earth Terminals	1 NEW
GSK335	35mm Triple + Earth Terminal	5
GSK335D	35mm 1G + 2G + Earth Terminal	5



GRID BACK BOXES

Code	Model	Qty
GDS668G	35mm 6-8G + Earth Terminals	1
GDS6912G	35mm 9-12G + Earth Terminals	1

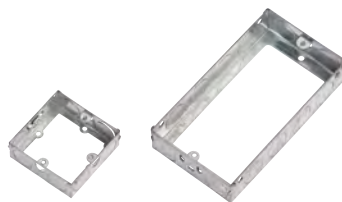

EXTENSION BOXES

Code	Model	Qty
GSE25	25mm Single	10
GSE225	25mm Double	5



1G SURFACE BOX

- Suitable for use with 1G Screwless and Flat Plate products from Knightsbridge
- 32mm deep

Code	Finish	
1G5BBK	Black	NEW
1G5BGY	Grey	NEW
1G5BW	White	NEW



Shown fitted with **SFQUADMW** (not included)



JUNCTION BOXES

- Heavy-duty construction
- Ideal for mains and low voltage installations

Code	Model	Qty
SN8400	5A - 4 Terminal - White 59mm	20
SN8400B	5A - 4 Terminal - Black 59mm	20
SN8410	20A - 4 Terminal - White 59mm	20
SN8410B	20A - 4 Terminal - Black 59mm	20
SN8420	20A - 4 Terminal - White 79mm	10
SN8420B	20A - 4 Terminal - Black 79mm	10

Code	Model	Qty
SN8430	30A - 3 Terminal - White 89mm	10
SN8430B	30A - 3 Terminal - Black 89mm	10
SN8460	20A - 6 Terminal - White 89mm	10
SN8460B	20A - 6 Terminal - Black 89mm	10
SN8470	60A - 3 Terminal - White	5
SN8470B	60A - 3 Terminal - Brown	5



SERVICE CONNECTOR BLOCKS

- Heavy-duty service connector blocks for use at meter and mains positions
- 100A 240V
- Black phenolic urea construction
- Secure sealable lid
- For max. 35mm² rigid conductor

Code	Model	Qty
SNEB1	SP 1 x 5-Way	10
SNEB2	DP 2 x 5-Way	10



CONTEMPORARY METAL PENDANT SETS

- 3 plate format
- Metal finish ceiling rose and lampholder
- Braided cord flex
- Contemporary styled lampholder

Code	Size	Model	
8270MB	6" T2 E27	Matt Black	NEW
8270MW	6" T2 E27	Matt White	NEW
8270BC	6" T2 E27	Brushed Chrome	NEW
8270PC	6" T2 E27	Polished Chrome	NEW
8270BN	6" T2 E27	Black Nickel	NEW
8270AB	6" T2 E27	Antique Brass	NEW
8270PB	6" T2 E27	Polished Brass	NEW

8300AB / 8300BN

ARRIVING
Q4 2020



Code	Model	
8300BC	10AX 2-Way (Brushed Chrome)	
8300PC	10AX 2-Way (Polished Chrome)	
8300MW	10AX 2-Way (Matt White)	NEW



Code	Model	
8300MB	10AX 2-Way (Matt Black)	NEW
8300AB	10AX 2-Way (Antique Brass)	NEW
8300BN	10AX 2-Way (Black Nickel)	NEW



VINTAGE METAL PENDANT SETS

- 3 plate format
- Metal finish ceiling rose and lampholder
- Braided cord flex
- Vintage styled lampholder



Code	Size	Model	
8271BC	6" T2 E27	Brushed Chrome	NEW
8271PC	6" T2 E27	Polished Chrome	NEW
8271BN	6" T2 E27	Black Nickel	NEW
8271AB	6" T2 E27	Antique Brass	NEW
8271PB	6" T2 E27	Polished Brass	NEW



PULL CORD SWITCHES

- Ideal for bathrooms and utility rooms
- With approx. 1.5m pull cord and matching pull cord cap

Code	Model	Qty
SN8290	10A 1-Way (White)	5
SN8300	10A 2-Way (White)	5
SN8310N	45A DP with Neon (White)	5



MOULDED PENDANT SETS

- 3 Plate format

Code	Size	Qty
SN8270	6" T2 BC	10
SN8280	9" T2 BC	10
8261	6" G24 18W Low Energy	1

T2 BC BATTEN HOLDERS

Code	Model	Qty
SN8200	H0 - 3 Terminals (BC)	10
SN8210	Straight Short Skirt (BC) - 3 Terminals	10
SN8220	Angled Short Skirt (BC) - 3 Terminals	10
SN8230	H0 with ceiling rose base (BC)	10



CEILING ROSE AND LAMPHOLDER

Code	Model	Qty
SN8260	Ceiling Rose - 3 Plate	10
SN8250	T2 BC Cord Grip Lampholder	20



EXTENSION LEADS

- With power indicator
- Low profile design

Code	Rating	Model
20042M	13A	4G 2m*
20043M	13A	4G 3m*
20062M	13A	6G 2m*

CORD SWITCHES

- 6A 230V
- Double pole switch
- Suitable for 1.5mm² cable



Code	Model	Qty
ST6AWH	White	10
ST6ABK	Black	10



INLINE REWIRABLE CORD DIMMERS

- 1-60W (1-25W LED)
- Trailing-edge dimmer
- Suitable for 0.75mm² twin flat cable

Code	Model
SN81WH	White
SN81BK	Black

SURGE PROTECTED EXTENSION LEADS

- With surge and power indicators

Code	Rating	Model
200452M	13A	4G 2m*
200652M	13A	6G 2m*
8GTOWER	13A	8G 2m*
12GTOWER	13A	12G 2m*

* Cable length is approximate



13A TRAILING SOCKETS

- Manufactured from high grade impact-resistant rubberised plastic

Code	Rating	Model	Qty
SN2013B	13A	1G Black	10
SN2013W	13A	1G White	10
SN2014B	13A	2G Black	10
SN2014W	13A	2G White	10

MAINS ADAPTORS & SOCKET COVERS

Code	Rating	Model	Qty
1350	13A	2-Way	10
1375	13A	3-Way (fused)	10
8910	13A	Shaver Adaptor (1A fuse)	20
1390	13A	Socket Blanking Plug	5

10A 3-PIN MAINS CONNECTORS

- Manufactured from high grade impact-resistant rubberised plastic

Code	Rating	Model	Qty
SN2121B	10A	Black	10
SN2121W	10A	White	10



RCD ADAPTORS / SOCKETS AND FUSED SPUR UNIT

- Latching type RCD • RCD trip current of 30mA • RCD trip speed of <40ms

Code	Rating	Model
RCD001	13A	RCD Safety Adaptor
RCD002	13A	RCD Safety Plug

Code	Rating	Model
RCD6000	13A	RCD Fused Spur Unit
RCD9000	13A	2G RCD Switched Socket



PLUG TOPS - DOMESTIC USE

- Screw type cord grip
- BSI Kitemarked

Code	Model	Qty
SN1382	3A Fuse - White	20
SN1381	5A Fuse - White	20
SN1383	13A Fuse - White	20
SN1383BK	13A Fuse - Black	20



PLUG TOPS - ROUGH USE

- Clamp type cord grip
- BSI Kitemarked
- TPE cover and nylon base

Code	Model	Qty
2135-RW	13A Fuse - White	20
2135-RB	13A Fuse - Black	20



PLUG TOPS - ROUND PIN

- Screw cord grip

Code	Model	Qty
132A	2A - White	20
SN135A	5A - White	20
SN1315A	15A - White	20



CARTRIDGE FUSES - DOMESTIC USE

- ASTA approved

Code	Model	Qty
SN3AFUSE	3A Fuse	10
SN5AFUSE	5A Fuse	10
SN13AFUSE	13A Fuse	10
SNMIXEDFUSE	Mixed Fuse Pack (3 x 3A, 3 x 5A, 4 x 13A)	10



STRIP CONNECTORS

- Terminal strips for connecting electrical cables
- Natural colour
- 12-Way
- 380V
- Made of PA66 material (UL94-V2 self extinguishing)
- Operating temperature: -30°C to +110°C

Code	Model	Qty
SC3PA	3A - 4mm ² Wire Capacity	10
SC5PA	5A - 6mm ² Wire Capacity	10
SC15PA	15A - 10mm ² Wire Capacity	10
SC30PA	30A - 16mm ² Wire Capacity	10
SC60PA	60A - 25mm ² Wire Capacity	10



RAISED HEAD ELECTRICAL SCREWS

- M3.5
- Raised head / Slotted
- Countersunk

Code	Model	Qty
CSCREW35	35mm	100
CSCREW50	50mm	100
CSCREW75	75mm	100

HOLESAWS

- 4/6 TPI Bi-metal variable teeth
- Suitable for cutting steel, stainless steel, die-cast metals, hardwood floors, plywood, and plastics



Code	Model	Code	Model
HS20MM	20mm	HS70MM	70mm
HS25MM	25mm	HS72MM	72mm
HS32MM	32mm	HS75MM	75mm
HS38MM	38mm	HS80MM	80mm
HS51MM	51mm	HS85MM	85mm
HS60MM	60mm	HS90MM	90mm
HS65MM	65mm		

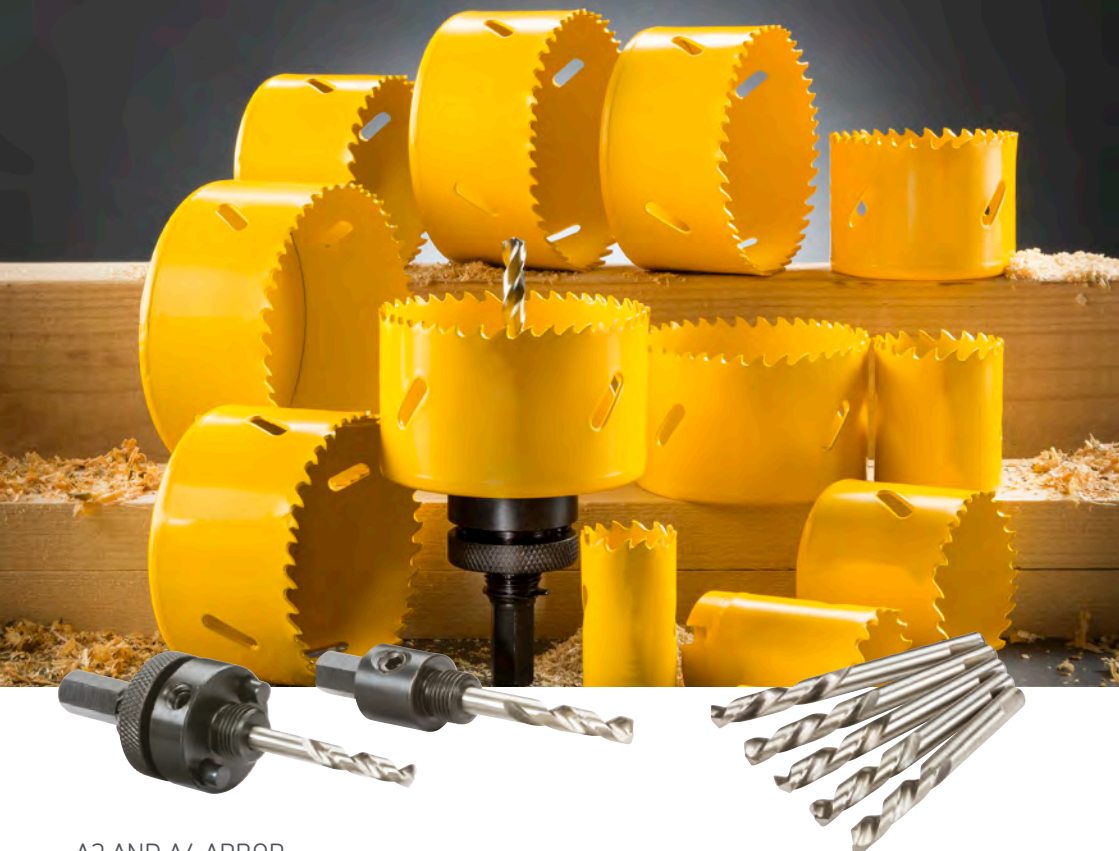

A2 AND A4 ARBOR

- A2 size Arbor with 11mm hex arbor shank and 6.3mm high speed pilot drill bit included
- A4 size Arbor with 9.5mm hex arbor shank and 6.3mm high speed pilot drill bit included

Code	Model
HSARBORL	A2
HSARBORS	A4

ARBOR DRILL BITS

- 6.35mm x 75mm

Code	Model
HSPILOTDB5	Pack of 5



SOCKET TESTER

- Tests for common wiring errors on BS 1363-2 13A sockets
- Simple to use and easy to diagnose faults

Code	Model
TE3	Socket Tester



REMOTE CABLE TESTER

Code	Model
XT468	Remote Cable Tester (RJ45/RJ11)

CAT IV NON-CONTACT VOLTAGE DETECTOR

- Voltage detection range: 90-1000V AC
- Audible and visual alerts for AC detection

Code	Model
TE4	Voltage Detector



PROFESSIONAL IDC TOOL

Code	Model
LJ5002	IDC Tool



IP64 2-POLE VOLTAGE TESTERS

- CAT III (690V) / CAT IV (600V) • Self-proving
- Built-in torch function

Code	Model
TE1	LED + LCD display
TE2	LED



DIGITAL LUX METER

- Easy to use handheld meter, ideal for surveying or testing light outputs

Code	Model
TE5	Lux Meter



NETWORK INSTALLATION KIT

- Contains: RJ45 Crimping Tool, Professional IDC Tool, Remote Cable Tester, 4-in-1 Cable Stripper Tool
- Supplied in secure zipper case

Code	Model
XT901BX	Network Tool Kit



HAVE A QUESTION? CHAT WITH OUR TEAM **INSTANTLY!**

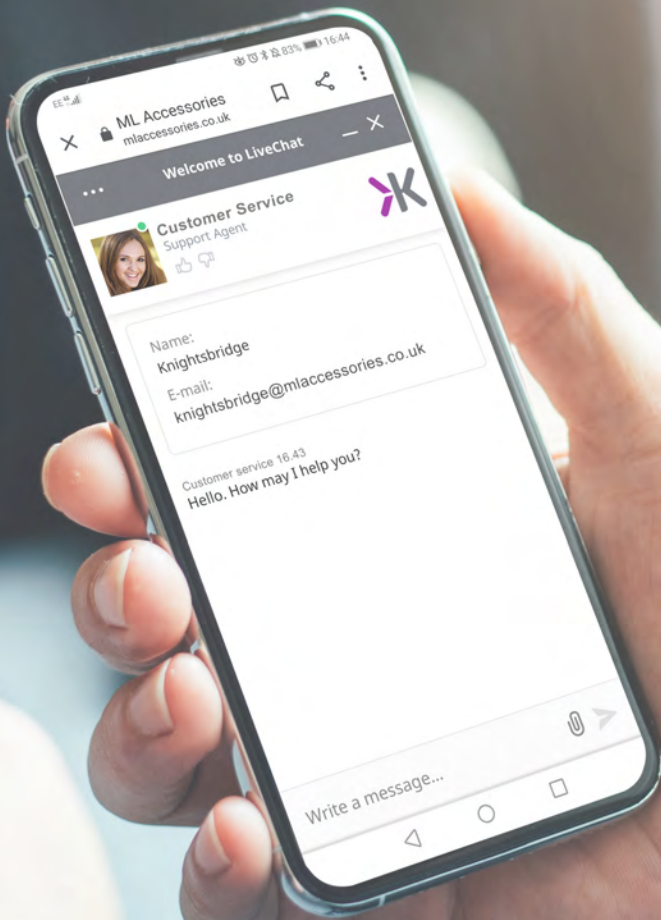

www.mlaccessories.co.uk



ADDITIONAL HARDWARE

Additional wiring accessories suitable a range of applications

Industrial Switches and Sockets / Rotary Isolators

154-155

Door Chimes

156-157

Extractor Fans and Extractor Fan Accessories

158-159



110V PLUGS AND SOCKETS

- Earth position - 4h
- Pin configuration - 2P+E
- Terminal capacity - max. 4.0mm² per terminal

110V

IP44

Code	Model	Description
IN001	16A	Plug
IN002	16A	Connector
IN003	16A	Surface Mount Socket*

Code	Model	Description
IN004	16A	Panel Mount Socket
IN005	16A	3-Way Splitter



240V PLUGS AND SOCKETS

- Earth position - 6h
- Pin configuration - 2P+E
- Terminal capacity - max. 4.0mm² per terminal

240V

IP44

Code	Model	Description
IN006	16A	Plug
IN0011	32A	Plug
IN007	16A	Connector
IN0023	32A	Connector
IN008	16A	Surface Mount Socket*
IN0012	32A	Surface Mount Socket*

Code	Model	Description
IN009	16A	Panel Mount Socket
IN0013	32A	Panel Mount Socket
IN0021	16A	Surface Mount Inlet*
IN0022	32A	Surface Mount Inlet*
IN0010	16A	3-Way Splitter

*Includes PG21 to M20 adapter



415V PLUGS AND SOCKETS

- Earth position - 6h
- Pin configuration - 3P+N+E
- Terminal capacity - max. 4.0mm² per terminal

415V

IP44

Code	Model	Description
IN0014	16A	Plug
IN0016	32A	Plug
IN0015	16A	Connector
IN0019	16A	Surface Mount Socket*

Code	Model	Description
IN0020	32A	Surface Mount Socket*
IN0017	16A	Panel Mount Socket
IN0018	32A	Panel Mount Socket



ROTARY ISOLATORS

- 230-415V
- Insulated 4P AC
- Modern rotary switch operation
- M20/M25 cable entries
- Interlocking lid ensures removal in OFF position only
- Handle can be padlocked for safety (padlock not included)

Code	Model
IN0025	20A
IN0026	32A
IN0027	63A

415V

IP65

*Includes PG21 to M20 adapter



PLUG-IN WIRELESS DOOR CHIMES

- IP44 bell push (CR2032 cell battery included)
- Plug-in mains powered receiver
- 36 polyphonic chimes with flash option
- Frequency: 315/433MHz
- 80m range (dependent on environment)

Code	Description
DC002	Black
DC003	White



WIRELESS DOOR CHIME

- IP44 bell push (CR2032 cell battery included)
- Battery powered receiver (batteries not included)
- 36 polyphonic chimes with flash option
- Frequency: 315/433MHz
- 200m range (dependent on environment)

Code	Description
DC001	Black



WIRELESS PIR ACTIVATED DOOR CHIME

- Wall or ceiling mountable PIR (batteries not included)
- Battery powered receiver (batteries not included)
- 36 polyphonic chimes with flash option
- Frequency: 315/433MHz
- 80m range (dependent on environment)
- Up to 8m range PIR

Code	Description
DC006	White



PLUG-IN DUAL ENTRANCE WIRELESS DOOR CHIME

- IP44 rated bell push x 2
(2 x CR2032 cell batteries included)
- Plug-in mains powered receiver
- 2 Door chime sounds - 1 for each bell push
- Frequency: 315/433MHz
- 100m range (dependent on environment)

Code	Description
DC007	White

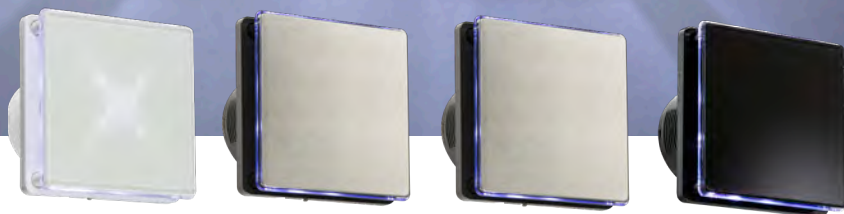
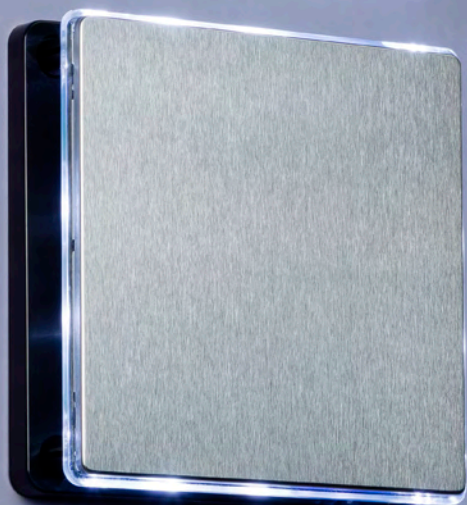

LED EXTRACTOR FAN

- Ideal solution for removing damp moist air, odours, and airborne pollutants from kitchens, toilets, and bathrooms
- Designed to be installed into walls and ceilings
- Modern design with built-in LED array, easy to wipe clean and convenient to duct over short lengths (2m max.)
- 100mm 4" size
- Profile depth of 40mm
- Built-in LED array
- Built-in overrun timer 2-30 mins
- Low noise level of just 35dBA @ 3m
- Extraction rate of 90m³/hr
- LED lighting effect during activation
- SFP: 0.52
- Compliant with latest Building Regulations (Part F)

Code	Model
EX003T	White
EX004T	Stainless Steel / Black

Code	Model	
EX004H	Stainless Steel / Black with Humidistat Function	NEW
EX005T	Black	NEW



EXTRACTOR FAN

- Ideal solution for removing damp moist air, odours, and airborne pollutants from kitchens, utility rooms, and bathrooms
- Designed to be installed into walls and ceilings
- Slim profile, compact, attractively styled, easy to wipe clean and convenient to duct over short lengths
- 100mm 4" size
- Profile depth 22mm
- Built-in overrun timer 2-30 mins
- Low noise level of just 35dBA @ 3m
- Extraction rate of 90m³/hr
- Compliant with latest Building Regulations (Part F) & (Part L)
- SFP: 0.44

IPX2



Code	Model
EX001T	4" Fan with Timer



ALUMINIUM DUCTING KIT

- 3m of expandable aluminium ducting
- Kit includes 2 x jubilee clips

Code	Model
EX4DUCT	4"



GRAVITY SHUTTERS

- Ideal fuss-free solution when you need to install ventilation in internal/external walls. Suitable for use with round ducting
- Prevents backdraught air and rain penetration
- Prevents objects or vermin entering when the ventilation is not in operation

Code	Model	Description
EX007B	4"	Black
EX007W	4"	White



FIXED GRILLES

- Ideal fuss-free solution when you need to install ventilation in internal/external walls. Suitable for use with round ducting
- Louvred vent with integral fly screen to keep insects out
- Removable front grilles allowing access for maintenance and cleaning of the fly screen

Code	Model	Description
EX009B	4"	Black
EX009W	4"	White



SMART HOME

Smart lighting and wiring accessories that are easy to control via the SmartKnight app

Smart Switched Socket	164
Smart Plug / Smart Extension Lead / Smart Outdoor Socket	165
Smart LED Fire-Rated Downlights / Smart Sensors	166-167
Smart RGBW + CCT Adjustable Downlights / Smart LED Flex Controller	168
Smart CCT Adjustable LED Panel Downlights	169



Welcome to the affordable world



With Knightsbridge, creating a smart home couldn't be simpler!

Our SmartKnight app enables users to control their appliances via their smartphone, including on/off, dimming, colour adjustment, and much more.

Please refer to the individual product listings within this section, or our website, for full details on what each smart product is capable of.



EASY INSTALL AND SETUP



Download



Add Device



Enjoy

Our smart products are designed for easy installation, with features such as push-fit terminals on downlights and retrofit capabilities on smart sockets

new, of **Smart Home**



NO HUB REQUIRED

Products connect directly via Wi-Fi enabling global remote access.

No space and money wasted on additional hubs / gateway devices

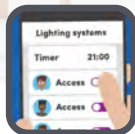

TIMERS

Set up schedules within the home, using the timer function to automate when devices turn on/off.



VOICE CONTROL

Voice control works with Hey Google or Amazon Alexa



GEOFENCING

Never come home to darkness; set up lights to automatically turn on/off based on your GPS location



SCENES

Utilise preset scenes such as 'Movie', or create your own.



SECURITY

Instant security alerts to your mobile device



Amazon, Alexa and all related logos are trademarks of Amazon.com, Inc. or its affiliates.

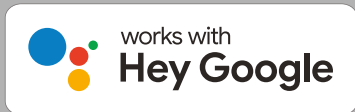

Google is a trademark of Google LLC.



13A 2G SMART SWITCHED SOCKET

- Control up to 2 appliances
- Manually override by using the switches on the socket
- Power monitoring function
- Minimum mounting box depth: 25-35mm (dependent on wiring conditions)
- Moulded square edge design

Code	Model
SN9KW	2G Switched Socket

NEW

**ARRIVING
Q4 2020**

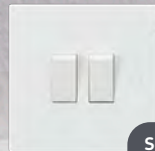

See pages
8-11
for matching
Square Edge
products

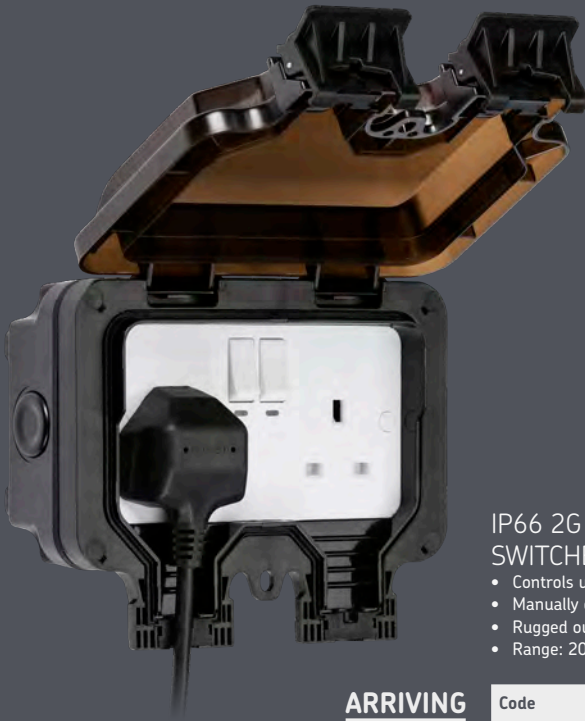

IP66 2G SMART OUTDOOR SWITCHED SOCKET

- Controls up to 2 outdoor appliances
- Manually override by using the switch on the socket
- Rugged outdoor enclosure
- Range: 20m-40m (depending on Wi-Fi signal coverage)

ARRIVING
Q4 2020

Code	Model
OP9KW	IP66 2G Outdoor Switched Socket NEW



16A SMART PLUG

- Controls 1 appliance
- Manually override by using the switch on the plug
- Power monitoring function
- Compact design

Code	Model
1GAKW	Smart Plug NEW

ARRIVING
Q4 2020



10A 3G SMART EXTENSION LEAD WITH QUAD USB CHARGER

- Control up to 3 appliances and the quad USB charger block
- Manually override by using the switch on the extension lead
- Surge protected
- 1.5m cable

Code	Model
3GKW	Smart Extension Lead NEW

ARRIVING
Q4 2020



SMART FIRE-RATED LED DOWNLIGHTS

- Both models: Adjust the colour temperature from warm white to cool white and everything in between (3000K – 5000K)
- RW6KRGBW only: Adjust the RGB colour, with over 16 million colour options
- Fire rated to 30, 60, 90 minutes

Construction: Aluminium & Steel

Driver: Included

Lamp type: LED

Beam angle: 40°



FOR BEZEL
OPTIONS SEE
PAGES 186-187

Cut-out ø	Overall ø	Minimum Void	(mm)
72	85	121	

Code	Wattage	Colour	Lumens	
RW6KW	6W	CCT adjustable ● ● ●	510lm (at 3000K)	NEW
RW6KRGBW	6W	RGB + CCT adjustable ● ● ● ● ● ● ● ● ● ●	440lm (at 3000K)	NEW



EASY INSTALLATION

No gateway product required – connects via Wi-Fi and SmartKnight app

LOWER POWER CONSUMPTION

Battery life of up to 1 year based on 20 activations per day

SECURITY & AUTOMATION

Apply sensor to doors and windows for peace of mind. 24/7 push notifications on a door or window breach. Combine with other products to turn on a light when activated

MONITORING

Use sensors to monitor a household's activities i.e. Front door opened/closed @ 16:00pm.

SMART MOTION SENSOR

- Compact size – just 64 x 64 x 30mm for discreet positioning
- Detects motion up to 4.5m distance with a detection angle of 100° when wall-mounted and 90° when ceiling mounted
- Easy Installation: simply mount to wall or ceiling with the magnetic mount

Code	Model	
OSMKW	Motion Sensor	NEW

SMART ENTRY SENSOR

- Compact size for discreet positioning around door and window frames
- Simple do-it-yourself installation, with adhesive pads (included)

Code	Model	
OSEKW	Entry Sensor	NEW



ARRIVING
Q4 2020



ARRIVING
Q4 2020





SMART RGBW + CCT ADJUSTABLE LED DOWNLIGHT

- Adjust the colour temperature from warm white to daylight and everything in between (3000K – 6500K)
- Adjust the RGB colour, with over 16 million colour options

Construction: Aluminium

Driver: Included

Lamp type: LED

Beam angle: 100°

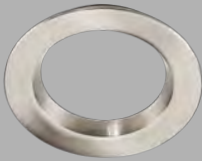

WD12BC



Cut-out ø	Overall ø	Minimum Void	(mm)
88	110	120	

Code	Wattage	Colour	Lumens	
WD12RGBW	12W	RGB + CCT adjustable ●●●●●●●●●●	875 – 1070lm	NEW
WD12BC			Brushed Chrome Bezel	NEW

230V
50Hz

IP44

VIA APP ONLY

LAMP INCLUDED

IC
RATED



SMART LED FLEX CONTROLLER

- Compatible with single colour, CCT, RGB and RGBW LED
- Enables users to adjust the colour temperature of their LED Flex, via the Smartknight app
- RGB and RGBW LED Flex only: Enables users to adjust the RGB colour via the Smartknight app

Code	Model	
LEDFWIFI	12V / 24V	NEW



See pages
228-242
for full
LED Flex
range



SMART CCT ADJUSTABLE LED PANEL DOWNLIGHTS

- Adjust the colour temperature from warm white to daylight and everything in between (3000K – 6000K)

Construction: Polycarbonate

Driver: Included

Lamp type: LED



FLEXIBLE MOUNTING
SURFACE OR RECESS MOUNTED
 (on ceilings and walls)



LOW PROFILE
 15mm

Minimum Void (mm)

50

Code	Wattage	Overall ø	Min/Max Cut-out	Colour	Lumens	
CPL18WCT	18W	217mm	55 – 175mm	CCT adjustable ● ●	1100 – 1400lm	NEW
CPL24WCT	24W	290mm	55 – 250mm	CCT adjustable ● ●	1700 – 2100lm	NEW

230V
50Hz

IP20



VIA APP
ONLY



LAMP
INCLUDED



For bezel
options
see page
311





DOMESTIC INTERIOR DOWNLIGHTS

Downlights ideal for domestic spaces, like living rooms, kitchens, and bathrooms. This diverse range includes Smart and Fire-Rated integral LED options

Recessed Downlights

Fixed Downlights / Tilt Downlights / Eyeball Downlights	172-173
Twist and Lock Downlights / Swivel and Scoop Downlights / Bathroom Downlights	174-175
Hole Converter kits / Fire hood / LED Emergency Pack	176

Fire-Rated Downlights

GU10 Fixed, Tilt, and IP65 Downlights	178-179
GU10 IC Fixed, Tilt and IP65 Downlights add / Bezels / Hol Converters	180-181
Evolve IC Fixed and Tilt Downlights	182-183

Fire-Rated LED Downlights

5W LED Downlights and Bezels	185
6W LED Downlights / 6W Smart LED Downlight	186-187
8W Valknight LED Fixed and Tilt Downlights	188-189
8W Proknight LED Fixed and Tilt Downlights	190-191
7W Fireknight LED Fixed and Tilt Downlights	192-193



RECESSED DOWNLIGHTS

FIXED DOWNLIGHTS

Construction: Pressed steel
Driver / Transformer: Required
Lamp type: MR16



Cut-out Ø	Overall Ø	Minimum Void	Recessed Depth	(mm)
58	80	110	92	

Code	Finish
L02B1	Brass
L02BK1	Black
L02C1	Chrome

Code	Finish
L02CBR1	Brushed Chrome
L02W1	White

TILT DOWNLIGHTS

Construction: Pressed steel
Driver / Transformer: Required
Tilt Angle: 15°
Lamp type: MR16



Cut-out Ø	Overall Ø	Minimum Void	Recessed Depth	(mm)
75	105	120	70	

Code	Finish
LG06C	Chrome
LG06CBR	Brushed Chrome

Code	Finish
LG06W	White

EYEBALL DOWNLIGHTS

Construction: Pressed steel
Driver / Transformer: Required
Tilt Angle: 15°
Lamp type: MR16



Cut-out Ø	Overall Ø	Minimum Void	Recessed Depth	(mm)
85	100	100	60	

Code	Finish
LE04C1	Chrome

Code	Finish
LE04W1	White

FIXED DOWNLIGHTS

Construction: Pressed steel
Driver / Transformer: Required
Lamp type: MR11 (35W max.)



Cut-out Ø	Overall Ø	Minimum Void	Recessed Depth	(mm)
42	60	120	70	

Code	Finish
L01C	Chrome
L01CBR	Brushed Chrome

Code	Finish
L01W	White



RECESSED DOWNLIGHTS

FIXED TWIST & LOCK DOWNLIGHTS

Construction: Die-cast aluminium

Driver: Driver / Transformer: Required for MR16 only

Lamp type: GU10 LED / MR16



Cut-out Ø	Overall Ø	Minimum Void	Recessed Depth	(mm)
70	79	140	90	

Code	Finish
RD1B	Brass
RD1C	Chrome

Code	Finish
RD1CBR	Brushed Chrome
RD1W	White

TILT TWIST & LOCK DOWNLIGHTS

Construction: Die-cast aluminium

Driver: Driver / Transformer: Required for MR16 only

Tilt Angle: 25°

Lamp type: GU10 LED / MR16



Cut-out Ø	Overall Ø	Minimum Void	Recessed Depth	(mm)
80	94	150	100	

Code	Finish
RD2B	Brass
RD2C	Chrome

Code	Finish
RD2CBR	Brushed Chrome
RD2W	White

SWIVEL & SCOOP DOWNLIGHTS

Construction: Die-cast aluminium

Driver / Transformer: Required

Tilt Angle: 80°

Lamp type: MR16



Cut-out Ø	Overall Ø	Minimum Void	Recessed Depth	(mm)
110	129	130	78	

Code	Finish
SWS01C	Chrome

Code	Finish
SWS01W	White

BATHROOM DOWNLIGHTS

Construction: Die-cast aluminium

Driver: Not Required

Lamp type: GU10 LED



Cut-out Ø	Overall Ø	Minimum Void	Recessed Depth	(mm)
64	84	140	90	

Code	Finish
RDSHC	Chrome
RDSHCBR	Brushed Chrome
RDSHW	White



HOLE CONVERTER KITS

- Complete with MR16 and GU10 LED lampholders and bridge



Cut-out Ø	Overall Ø	(mm)
78 to 120	140	

Code	Finish
HCBC	Brushed Chrome
HCC	Chrome
HCW	White



FIRE HOOD

- Made with breathable intumescent material
- Allows heat from the lamp to be dissipated preventing the terminal block and downlight from overheating
- The fire hood is flexible and light and can be used in plasterboard, concrete, or suspended ceilings
- 60 minute rated

Height	Overall Ø	(mm)
150	150	

Code	Finish
FR150	White



LED EMERGENCY PACK

- Pre-wired with easy-fix connectors and LED charge indicator
- For maintained and non-maintained use

Construction: Polycarbonate

Lamp type: GU10 LED (6W max.)

Cut-out Ø	(mm)
55	

Code	Finish
EMGUKIT1	White



IC RATED

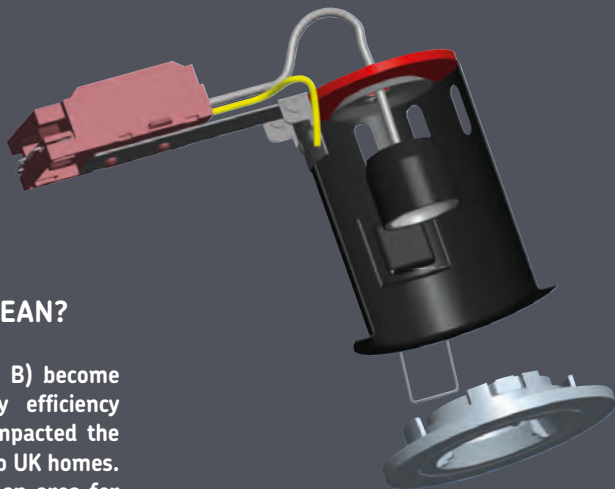

WHAT DOES IC RATED MEAN?

As building regulations (L1 A & B) become ever more focused on energy efficiency and energy saving, they have impacted the traditional products installed into UK homes. Loft spaces were recognised as an area for heat loss, even more so when several holes for downlights were cut into the ceiling.

Building regulations Part L1A and L1B state: 'The building fabric should be constructed so that there is no reasonably avoidable thermal bridges in the insulation layer'. This means that where possible the insulation layer should lay un-broken to prevent heat loss, which causes issues for traditional halogen downlights in several ways.

Latest standards now require homes to be compliant both in energy efficiency and energy saving and the modern downlight has had to adapt. Traditionally a downlight causes many issues, cutting a hole to install compromises the fire barrier of the ceiling and acoustic rating but also causes an increase in heat loss and moisture transfer to the ceiling void. Added to this, manufacturer's recommendations would be to remove the insulation layer away from the immediate area around and above the downlight allowing it to dissipate heat build-up and

to remove any possible fire hazard due to debris. Doing so creates thermal bridges, where lower thermal resistance allows heat to escape.

Most fire-rated downlights address the issues to re-instate the fire barrier, acoustic rating and moisture transfer, however the heat loss remains an issue as most are not able to be covered with insulation. To do so would allow the heat generated by the lamp to be trapped by the insulation causing early lamp failure and potential discolouration of the downlight and the ceiling around it.

Knightsbridge® Insulation contact (IC) rated products take this one step further. Without a requirement for additional accessories, these innovative products allow glass or rock mineral wool insulation to be laid, without gaps, directly over the downlight. Its construction allows heat to dissipate through the ventilated body whilst maintaining the structural integrity of the ceiling and not contravening building regulations.



Building regulations Part L1A and L1B state that...“The building fabric should be constructed so that there is no reasonably avoidable thermal bridges in the insulation layer”

DATA SHEETS AVAILABLE : WWW.MLACCESSORIES.CO.UK



FIXED GU10 DOWNLIGHTS

Construction: Pressed steel

Driver: Not Required

Lamp type: GU10 LED



- Fast-fix installation
- Supplied with bezel which can be easily removed for decorating / painting
- Available in Fixed, Tilt, and IP65 options, and comes in a choice of popular finishes
- Product includes screwless terminal block; tool-free installation; loop in / loop out, fast-fix fitting
- Tested to 30/60/90mins - solid wood Joists

Cut-out Ø	Overall Ø	Minimum Void	Recessed Depth	(mm)
65	85	126	100	

Code	Finish	
VFCFBC	Brushed Chrome	NEW
VFCFC	Chrome	NEW
VFCFW	White	NEW



TILT GU10 DOWNLIGHTS

Construction: Pressed steel
Driver: Not Required
Lamp type: GU10 LED
Tilt: 15°



Cut-out Ø	Overall Ø	Minimum Void	Recessed Depth	(mm)
80	91	138	113	

Code	Finish	
VFCFTBC	Brushed Chrome	NEW
VFCFTC	Chrome	NEW
VFCFTW	White	NEW



IP65 GU10 DOWNLIGHTS

Construction: Pressed steel
Driver: Not Required
Lamp type: GU10 LED



Cut-out Ø	Overall Ø	Minimum Void	Recessed Depth	(mm)
69	84	142	117	

Code	Finish	
VFCFIPBC	Brushed Chrome	NEW
VFCFIPC	Chrome	NEW
VFCFIPW	White	NEW



For lamps,
see page
369



FIRE-RATED DOWNLIGHTS

FIXED GU10 IC DOWNLIGHTS

Construction: Pressed steel & aluminium

Driver: Not required

Lamp type: GU10 LED

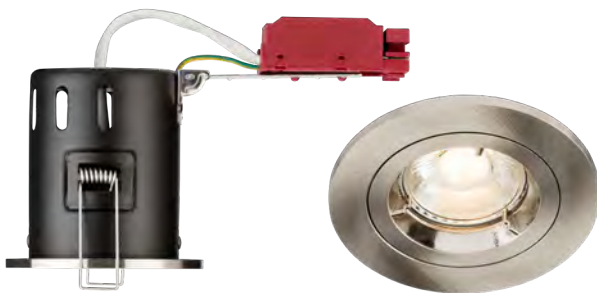

Cut-out Ø	Overall Ø	Minimum Void	Recessed Depth	(mm)
72	87	160	105	

Code	Finish
VFRDGCIB	Brass
VFRDGCIC	Chrome
VFRDGCICBR	Brushed Chrome
VFRDGCICW	White



TILT GU10 IC DOWNLIGHTS

Construction: Pressed steel & aluminium

Driver: Not required

Lamp type: GU10 LED

Tilt: 15°

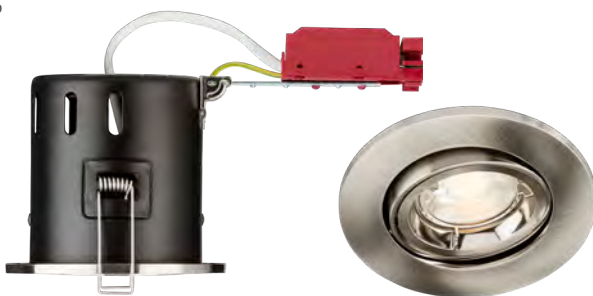

Cut-out Ø	Overall Ø	Minimum Void	Recessed Depth	(mm)
84	101	160	105	

Code	Finish
VFRSGICB	Brass
VFRSGIC	Chrome
VFRSGICBR	Brushed Chrome
VFRSGICW	White



*With mineral wool style insulation only, please see page 177 and product instructions for more information



GU10 IC SHOWER DOWNLIGHTS

Construction: Pressed steel & aluminium

Driver: Not required

Lamp type: GU10 LED

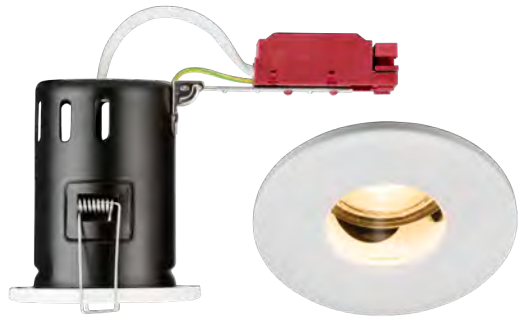

Cut-out Ø	Overall Ø	Minimum Void	Recessed Depth	(mm)
70	87	175	118	

Code	Finish
VFRSHGICB	Brass
VFRSHGICC	Chrome
VFRSHGICCBR	Brushed Chrome
VFRSHGICW	White



*With mineral wool style insulation only, please see page 177 and product instructions for more information



FIRE-RATED DOWNLIGHTS

- 230V 50W max. fire-rated downlight can
- Compatible with all standard GU10 LED lamps
- EASY-fix loop in / loop out screwless terminal
- Dimmable subject to light source
- Interchangeable tilt and fixed bezels



(Shown with bezel - bezel not included)

EVOLVE IC FIXED STANDARD CAN

Construction: Pressed steel
Driver: Not required
Lamp type: GU10 LED

Cut-out Ø	Overall Ø	Minimum Void	Recessed Depth	(mm)
68	82	170	119	

Code	Finish
EVOICF	Black

230V
50Hz

IP20



EVOLVE FIXED BEZELS

Code	Finish
EVOABF	Antique Brass
EVOBCF	Brushed Chrome
EVOBKF	Black
EVOBRF	Brass
EVOCHF	Chrome
EVOGMF	Gunmetal
EVOWHF	White



EVOLVE HOLE CONVERTERS

Construction: Pressed steel
 Compatible with EVOICF fixed downlights

Overall Ø	Cut-out Box	(mm)
180	80-135	

Code	Finish
EVOCBC	Brushed Chrome
EVOCC	Chrome
EVOCW	White

EVOLVE IP65 BEZELS

Code	Finish
EVOIPBC	Brushed Chrome
EVOIPCH	Chrome
EVOIPWH	White



*With mineral wool style insulation only, please see page 177 and product instructions for more information

EVOLVE IC TILT DOWNLIGHT

Construction: Pressed steel
Driver: Not required
Lamp type: GU10 LED



(Shown with bezel - bezel not included)

Cut-out Ø	Overall Ø	Minimum Void	Recessed Depth	(mm)
80	90	170	119	

Code	Finish
EVOICT	Black



EVOLVE TILT BEZELS

Overall Ø	(mm)
90	



Code	Finish
EVOABT	Antique Brass
EVOBCT	Brushed Chrome
EVOBKT	Black
EVOBRT	Brass

Code	Finish
EVOCHT	Chrome
EVOGMT	Gun Metal
EVOWHT	White



FOR
LAMPS
SEE PAGE 369

*With mineral wool style insulation only, please see page 177 and product instructions for more information

THE POWER OF

LED

FROM

Knightsbridge



UPTO
90%
SAVING

	Energy Used	Approx. Equivalent Lamp	Approx. Equivalent Lamp	Approx. Equivalent Lamp
450 lumens	40W £6.79/year	29W £4.92/year	11W £1.87/year	4W £0.68/year
800 lumens	60W £10.18/year	43W £7.30/year	13W £2.21/year	8W £1.36/year
1100 lumens	75W £12.73/year	53W £8.99/year	20W £3.39/year	11W £1.87/year
1600 lumens	100W £16.97/year	72W £12.22/year	23W £3.90/year	16W £2.72/year
	upto 1 YEAR lifespan	upto 1-3 YEARS lifespan	upto 6-10 YEARS lifespan	upto 15-20 YEARS * lifespan

Lighting accounts for 20-30% of electric bills

* Lifespan and estimated energy cost per year based on 3 hours of use per day at 15.5p per kWh

COLOUR TEMPS



DAYLIGHT 6000K

COOL WHITE 4000K

WARM WHITE 3000K

LIGHT COVERAGE

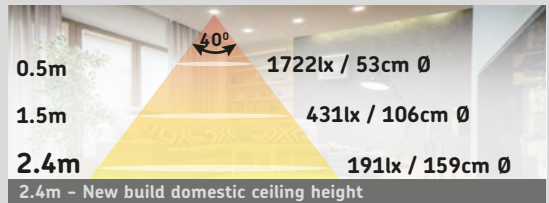

LAMP TYPES



5W INTEGRATED LED DOWNLIGHTS

- Push-fit terminals with loop-in / loop-out for easy wiring
- Fire tested to 30, 60 and 90 minutes
- Supplied with white bezel as standard

Construction: Pressed Steel

Driver: Integral

Lamp type: LED



Cut-out Ø	Overall Ø	Minimum Void (mm)
55	84	100

Code	Wattage	Colour	CCT	Lumens	
CFR5WW	5W	Warm White	3000K	570lm	NEW
CFR5CW	5W	Cool White	4000K	570lm	NEW



BEZELS

Construction: ABS

Code	Finish	
CFRB	Brass	NEW
CFRBC	Brushed Chrome	NEW
CFRPC	Polished Chrome	NEW



Overall Ø (mm)

87



FIRE-RATED DOWNLIGHTS

6W INTEGRATED LED DOWNLIGHTS

- Tested to 30, 60 and 90 minutes fire-rated ceilings
- IP65 as standard
- Supplied with white bezel as standard

Construction: Aluminium & Polycarbonate

Driver: Integral

Lamp type: LED

Beam Angle: 40°



LOOP-IN/LOOP OUT WITH PUSH-FIT TERMINALS



CCT ADJUSTABLE DOWNLIGHT RW6CCT

Switch between 3 colour temperatures at the flick of a switch or push dimmer (memory function included)

WARM WHITE
3000K
Also available on:
RW6WW, RW6DTW

COOL WHITE
4000K
Also available on:
RW6CW

DAYLIGHT
6000K

Cut-out Ø	Overall Ø	Minimum Void	(mm)
72	85	120	

Code	Wattage	Colour	CCT	Lumens
RW6WW	6W	Warm White	3000K	595lm
RW6CW	6W	Cool White	4000K	690lm
RW6DTW	6W	Dim-to-warm	2200K to 3000K	435lm (at 3000K)
RW6CCT	6W	CCT Adjustable	3000K / 4000K / 5000K	595lm / 695lm / 665lm

230V
50Hz

IP65

LAMP
INCLUDED

5
YEAR
WARRANTY

IC*
RATED

BEZELS

Construction: Pressed Steel

Code	Finish
RW6BC	Brushed Chrome
RW6C	Chrome
RW6MB	Matt Black
RW6MW	Matt White



Height	Overall Ø	(mm)
4	85	



SMART FIRE-RATED LED DOWNLIGHTS

- Both models: Adjust the colour temperature from warm white to cool white and everything in between (3000K – 5000K)
- **RW6KRGBW** only: Adjust the RGB colour, with over 16 million colour options
- Fire rated to 30, 60, 90 minutes
- Supplied with white bezel as standard

Construction: Aluminium & Polycarbonate

Driver: Included

Lamp type: LED

Beam angle: 40°



WIRELESS DIMMABLE - Knightsbridge
CCT LED POWER DRIVER
 Model: RW6KRW
 Input: 220-240V~50/60Hz 0.03A
 Output: 6V~30V max. 1.00mA-500mA
 Power: 6W max.
 F=0.9 Flicker-free
 FI Connector: IEEE802.11b/g/n 12-24G
 15°C to 75°C

VISIT **SMARTHOME** on pages 164-169

Cut-out ø	Overall ø	Minimum Void	(mm)
72	85	120	
Code	Wattage	Colour	Lumens
RW6KW	6W	CCT adjustable ● ● ●	510lm (at 3000K) NEW
RW6KRGBW	6W	RGBW + CCT adjustable ● ● ● ● ● ● ● ● ● ●	440lm (at 3000K) NEW

230V
50Hz

IP65

VIA APP ONLY

LAMP INCLUDED

IC
 RATED

FLAT BEZELS

Construction: Pressed Steel

Code	Finish
RW6FBC	Brushed Chrome
RW6FBR	Brass
RW6FC	Chrome
RW6FMB	Matt Black
RW6FMW	Matt White

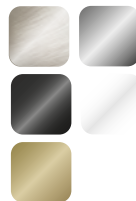

Height	Overall ø	(mm)
2.6	85	

*With mineral wool style insulation only, please see page 177 and product instructions for more information



FIRE-RATED DOWNLIGHTS

- IC rated for use under mineral wool insulation (when installed in conjunction with IC* cage)
- 3 easy-fit coloured bezels are available in chrome, brushed chrome or white finish (not included)
- Complete with IC rated dimmable driver

VALKNIIGHT 8W INTEGRATED LED DOWNLIGHTS

Construction: Die-cast aluminium

Driver: Included

Lamp type: LED

Beam Angle: 40°



Bezel not included



Cut-out Ø	Overall Ø	Minimum Void	Recessed Depth	(mm)
65	80	100	50	

Code	Wattage	Colour	CCT	Lumens
VFRIC8WW	8W	Warm White	3000K	580lm
VFRIC8CW	8W	Cool White	4000K	640lm



BEZELS / IC-RATED CAGE

Construction: Die-cast aluminium

IC Rated Cage Construction: Polycarbonate

Code	Model
VFRICBEZC	Chrome
VFRICBEZCBR	Brushed Chrome
VFRICBEZW	White
VFRICC	IC-Rated Cage



*With mineral wool style insulation only, please see page 177 and product instructions for more information. IC rated with cage only

VALKNIGHT 8W INTEGRATED LED TILT DOWNLIGHTS

Construction: Die-cast aluminium
Driver: Included
Lamp type: LED
Beam Angle: 40°
Tilt: 25°

(Bezel not included)



Cut-out Ø	Overall Ø	Minimum Void	Recessed Depth	(mm)
75	88	100	55	

Code	Wattage	Colour	CCT	Lumens
VFRIC8TWW	8W	Warm White	3000K	580lm
VFRIC8TCW	8W	Cool White	4000K	640lm

TILT BEZELS / IC-RATED CAGE

Construction: Aluminium

IC Rated Cage Construction: Polycarbonate

Code	Model
VFRICTBEZC	Chrome
VFRICTBEZCBR	Brushed Chrome
VFRICTBEZW	White
VFRICTC	IC-Rated Cage



IC-Rated Cage (Code: VFRICTC)



EMERGENCY LIGHTING ACCESSORIES

- Compatible with Tilt and standard Valknight models
- Downlight not included



Code	Model
VFR7EM	Emergency Conversion Kit
ICEMC	Emergency Conversion Connector Leads

*With mineral wool style insulation only, please see page 177 and product instructions for more information. IC rated with cage only



FIRE-RATED DOWNLIGHTS

- Lightweight, low profile model incorporating an aluminium heat sink
- Complete with driver and loop in / loop out screwless terminal block
- Low energy downlights offering a true 'halogen feel'



PROKNIIGHT 8W INTEGRATED LED DOWNLIGHTS

Construction: Die-cast aluminium

Driver: Included

Lamp type: CoB LED

Beam Angle: 38°



Cut-out Ø	Overall Ø	Minimum Void	Recessed Depth	(mm)
64	80	97	41	

Code	Wattage	Colour	CCT	Lumens
VFR8WW	8W	Warm White	2700K	615lm
VFR8CW	8W	Cool White	4000K	690lm

BEZELS

Construction: Die-cast aluminium

Height	Overall Ø	(mm)
3.8	80	

Code	Finish
VFR8BEZBL	Black
VFR8BEZBR	Brass
VFR8BEZCBR	Brushed Chrome
VFR8BEZCH	Chrome
VFR8BEZMW	Matt White



For Hole
Converters,
see page 193



FIRE-RATED DOWNLIGHTS

- Exclusive range of interchangeable bezels also available
- Compliant with PART B – BS476 Part 23 (Fire Safety) 30, 60 & 90 minutes
- Up to 35,000 hours average lamp life
- Supplied without bezel



PROKNIGHT 8W INTEGRATED LED TILT DOWNLIGHTS

Construction: Die-cast aluminium & steel

Driver: Included

Lamp type: CoB LED

Beam Angle: 38°

Tilt: 25°



Cut-out Ø	Overall Ø	Minimum Void	Recessed Depth	(mm)
74	88	97		

Code	Wattage	Colour	CCT	Lumens
VFR8TWW	8W	Warm White	2700K	615lm
VFR8TCW	8W	Cool White	4000K	690lm

TILT BEZELS

Construction: Die-cast aluminium

Height	Overall Ø	(mm)
3.8	88	

Code	Finish
VFR8TBEZBL	Black
VFR8TBEZBR	Brass
VFR8TBEZCBR	Brushed Chrome
VFR8TBEZCH	Chrome
VFR8TBEZMW	Matt White



EMERGENCY KIT

Code	Finish
VFR7EM	White





FIRE-RATED DOWNLIGHTS

- Low energy downlights offering a true 'halogen feel'
- Supplied with a pre-wired 'plug & play' dimmable LED driver
- All models are fire-rated to 90 mins
- An extended warranty of up to 7 years is available on request*

* Conditions apply. See website for details

FIREKNIGHT 7W INTEGRATED LED DOWNLIGHTS

- Optional round and square bezels available
- Supplied with white bezel as standard

Construction: Die-cast Aluminium
Beam Angle: 38°



Cut-out Ø	Overall Ø	Minimum Void	Recessed Depth	(mm)
65	80	110	60	

Code	Wattage	Colour	CCT	Lumens
VFRCOBWW	7W	Warm White	3000K	545lm
VFRCOBCW	7W	Cool White	4000K	580lm



ROUND & SQUARE BEZELS

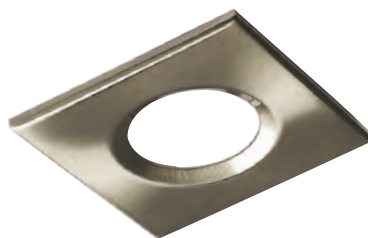

Code	Model	Finish
VFRBEZAB	Round	Antique Brass
VFRBEZBK	Round	Black
VFRBEZBR	Round	Brass
VFRBEZCBR	Round	Brushed Chrome
VFRBEZCH	Round	Chrome
VFRBEZGM	Round	Gunmetal
VFRBEZW	Round	White

Code	Model	Finish
VFRSBEZBK	Square	Black
VFRSBEZCBR	Square	Brushed Chrome
VFRSBEZCH	Square	Chrome
VFRSBEZW	Square	White

FIREKNIGHT 7W INTEGRATED LED TILT DOWNLIGHTS

- Please note, bezels are not interchangeable on Fireknight tilt downlights

Construction: Die-cast Aluminium

Beam Angle: 38°

Tilt: 25°



Cut-out Ø	Overall Ø	Minimum Void	Recessed Depth (mm)
74	88	106	56



Code	Wattage	Bezel	Colour	CCT	Lumens
VFCOBWW1	7W	White	Warm White	3000K	545lm
VFCOBWW2	7W	Chrome	Warm White	3000K	545lm
VFCOBWW3	7W	Brushed Chrome	Warm White	3000K	545lm
VFCOBCW1	7W	White	Cool White	4000K	580lm
VFCOBCW2	7W	Chrome	Cool White	4000K	580lm
VFCOBCW3	7W	Brushed Chrome	Cool White	4000K	580lm

EMERGENCY KIT

Code	Wattage
VFR7EM	7W



HOLE CONVERTERS

- Enables fixed downlights to be used in 65mm-130mm cut-outs
- Lamps not included with hole converters

Construction: Pressed Steel

Height	Cut-out Ø	Overall Ø (mm)
6.5	65 - 130	180

Code	Finish
VFCBC	Brushed Chrome
VFRCC	Chrome
VFCRW	White



Suitable for fixed versions only



DOMESTIC INTERIOR CEILING & WALL LIGHTS

Decorative ceiling, track, and wall lighting designed to enhance living spaces

Ceiling Lights

Spotlights	196-199
Track Spotlights	200-201
LED Track Spotlights	202
Track and Accessories	203

Wall Lights

Up/Down Wall Lights	204
LED Plinth Lights / LED Recessed Wall Lights	205



SINGLE SPOTLIGHT

- Suitable for wall or ceiling mounting

Construction: Steel

Lamp type: GU10 LED

Base Ø	Projection	(mm)
80	110	

Code	Finish
NSPGU1BC	Brushed Chrome
NSPGU1C	Chrome
NSPGU1W	White



DOUBLE SPOTLIGHT

Construction: Steel

Lamp Type: GU10 LED

Base Ø	Width	Projection	(mm)
90	360	135	

Code	Finish
NSPGU2BC	Brushed Chrome
NSPGU2C	Chrome



TRIPLE SPOTLIGHT



Construction: Steel

Lamp Type: GU10 LED

Base Ø	Projection	(mm)
200	110	

Code	Finish
NSPGU3BC	Brushed Chrome
NSPGU3C	Chrome

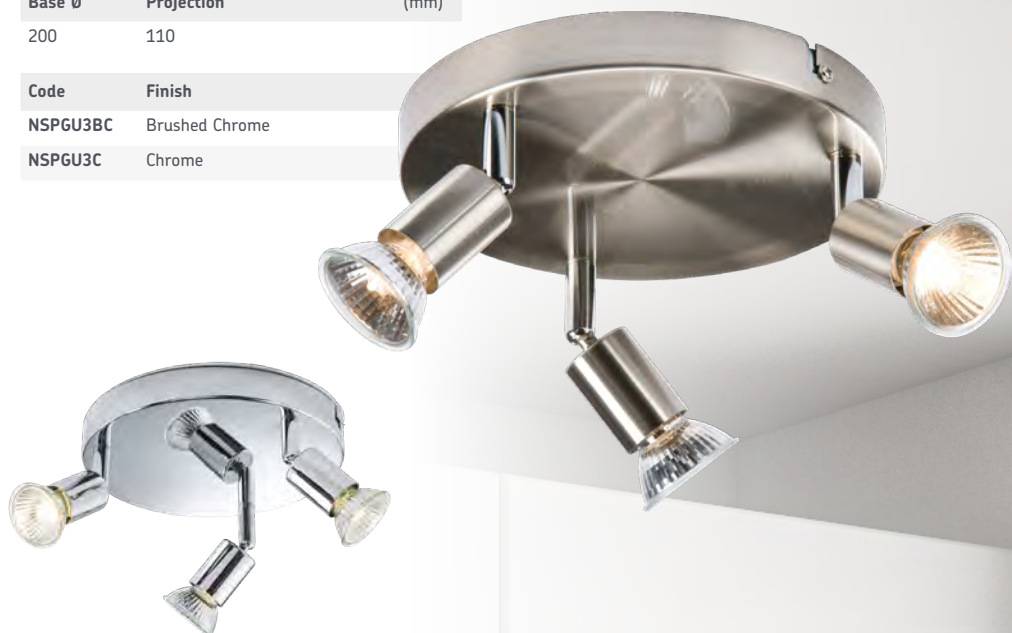

QUAD SPOTLIGHT

Construction: Steel

Lamp Type: GU10 LED

Base Ø	Width	Projection	(mm)
90	765	135	

Code	Finish
NSPGU4BC	Brushed Chrome
NSPGU4C	Chrome



230V
50Hz

IP20





SINGLE SPOTLIGHT

- Can be wall mounted

Construction: Stainless Steel

Lamp type: GU10 LED

Width	Projection	Length	(mm)
80	186	120	

Code	Finish
NSP1C	Chrome



TRIPLE SPOTLIGHT

Construction: Stainless Steel

Lamp type: GU10 LED

Width	Projection	Length	(mm)
80	190	500	

Code	Finish
NSP3C	Chrome



QUAD SPOTLIGHT

Construction: Stainless Steel

Lamp type: GU10 LED

Width	Projection	Length	(mm)
80	190	640	

Code	Finish
NSP4C	Chrome



230V
50Hz

IP20



LAMP NOT
INCLUDED



TRKSP1

Construction: Aluminium
Lamp type: GU10 LED

Height	Width	Projection	Length (mm)
142	32	128	50

Code	Finish
TRKSP1BC	Brushed Chrome
TRKSP1BK	Black
TRKSP1W	White

TRACK LIGHTING

TRKSP2

Construction: Aluminium
Lamp type: GU10 LED

Height	Overall Ø	Projection	Length (mm)
145	34	131	50

Code	Finish
TRKSP2BC	Brushed Chrome
TRKSP2BK	Black
TRKSP2W	White



TRKSP3

Construction: Aluminium
Lamp type: GU10 LED

Height	Overall Ø	Projection	Length (mm)
144	35	130	50

Code	Finish
TRKSP3BC	Brushed Chrome
TRKSP3BK	Black
TRKSP3W	White



TRKSP4

Construction: Aluminium
Lamp type: GU10 LED

Height	Overall Ø	Projection	Length (mm)
170	58	155	105

Code	Finish
TRKSP4BC	Brushed Chrome
TRKSP4BK	Black
TRKSP4W	White



TRKSP5

Construction: Zinc Alloy
Lamp type: GU10 LED

Height	Overall Ø	Projection	Length (mm)
175	56	160	75

Code	Finish
TRKSP5BC	Brushed Chrome
TRKSP5BK	Black
TRKSP5W	White



TRKSP6

Construction: Aluminium & Glass
Lamp type: G9 LED

Height	Overall Ø	Projection	Length (mm)
179	60	164	82

Code	Finish
TRKSP6BC	Brushed Chrome
TRKSP6BK	Black
TRKSP6W	White



TRKSP8

Construction: Aluminium
Lamp type: GU10 LED

Height	Overall Ø	Projection	Length (mm)
176	56	163	81

Code	Finish	
TRKSP8BC	Brushed Chrome	NEW
TRKSP8B	Black	NEW
TRKSP8W	White	NEW





LED TRACK SPOTLIGHTS

- Integral LED directional tracklights
- Dimmable with most trailing-edge dimmers
- 350° rotation, 80° tilt, and 45° beam angle
- Reflector accessories available for 24° beam angle
- Tracklights require track for power source

Construction: Die-Cast Aluminium

Driver: Integral

Lamp type: CoB LED

Height	Overall Ø	Projection	Length (mm)
154	55	142	80

Code	Wattage	Finish	Colour	CCT	Lumens
TRKSP7BCWW	9W	Brushed Chrome	Warm White	3000k	720lm
TRKSP7BWW	9W	Black	Warm White	3000k	720lm
TRKSP7WWW	9W	White	Warm White	3000k	720lm
TRKSP7BCCW	9W	Brushed Chrome	Cool White	4000k	790lm
TRKSP7BCW	9W	Black	Cool White	4000k	790lm
TRKSP7WCW	9W	White	Cool White	4000k	790lm

TRKSP7R 24° Degree Reflector

TRKSP7R



230V
50Hz

IP20



3
YEAR
WARRANTY



To indicate preferred finish, replace xx on code with S (Satin Nickel), BK (Black), or W (White)

230V 16A SINGLE CIRCUIT TRACK

Code	Length
TRK1Mxx	1m
TRK2Mxx	2m
TRK3Mxx	3m

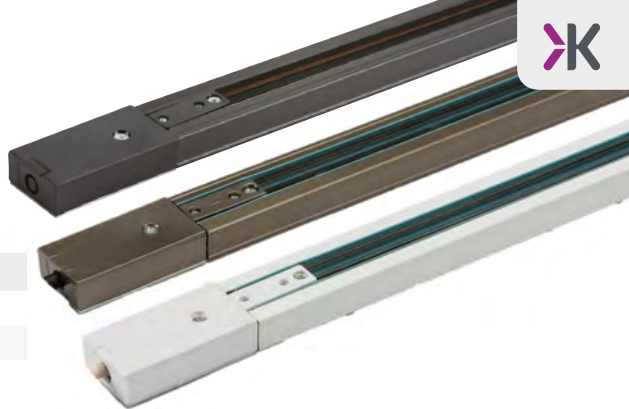

TRACK ACCESSORIES

Code	Length
TRKCxx	Track Connector
TRKDExx	Dead End Cap
TRKFCxx	Flexible Connector
TRKLCxx	Inline Connector
TRKPFxx	Power Feed
TRKRAxx	Right Angle Connector
TRKTxx	T-Connector
TRKXxx	X-Connector

TRKCS



TRKDES



TRKRA



TRKTS



TRKFC



TRKLC



TRKXS



TRACK ADAPTOR

Code	Length
TRKADxx	Track Adaptor

230V
50Hz

IP20



NH0183BD



NH0184SQ



UP/DOWN WALL LIGHTS

- Lamp colours can be changed to add colour and ambience as required

Construction: Stainless Steel

Lamp type: GU10 LED

230V
50Hz

IP20



Code	Model	Height	Overall Ø	Width	Projection	Base
NH0183BD	Tubular	161mm	60mm	-	85mm	Ø 78mm
NH0184SQ	Square	161mm	-	60mm	99mm	W: 60mm x H: 60mm

LED PLINTH LIGHTS

- Ideal for placement in staircases
- Fits standard UK steel back boxes and dry lining boxes
- Minimum mounting depth: 25mm
- Cool white 4000K

Construction: Stainless Steel

Lamp type: LED

Height	Width	Projection	(mm)
87.5	87.5	4.3	

Code	Finish	
SFPLBC	Brushed Chrome	NEW
SFPLMW	Matt White	NEW



LED RECESSED WALL LIGHTING

Recessed LED guide light complete with integral driver. Ideal for stairways and corridors.

- Brushed chrome finish
- Manufactured to fit a standard 47mm recessed back box (not supplied)
- Low level guide lighting creates a soft ambient glow
- For indoor use only

Construction: Stainless Steel

Lamp type: LED

Height	Width	Projection	(mm)
80	80	5	

Code	Wattage	Colour	Lumens
NH023B	1W	Blue	-
NH023W	1W	White	80lm
NH025W	1W	White (4 squares)	80lm



230V
50Hz

IP20





DOMESTIC INTERIOR BATHROOM

Stylish mirrors and lighting that complement any modern bathroom. Range includes shaver lights with USB ports

LED Wall Lights	208
Shaver Lights	209-210
Over-mirror Lights	211
Mirrors	212-213
Downlights / Recessed Wall Lights	214



SINGLE / TWIN LED WALL LIGHTS

Construction: Pressed steel

Driver: Included

Lamp type: LED

Height	Projection	Base Ø (mm)
252.5 (CWL1) 405 (CWL2)	115	100



Code	Model	Wattage	Finish	Colour	CCT	Lumens
CWL1	Single	3W	Chrome	Warm White	3000K	170lm
CWL2	Twin	6W	Chrome	Warm White	3000K	365lm

LED WALL LIGHTS

Construction:
Aluminium & Polycarbonate (BWLED4)
/ Polycarbonate (BWLED9)

Driver: Integral

Lamp type: LED



Width	Height	Projection	(mm)
600	52	64 (BWLED4) 69 (BWLED9)	

Code	Model	Wattage	Finish	Colour	CCT	Lumens
BWLED4	With Pull Cord Switch	15W	Chrome	Warm White	3000K	1300lm
BWLED9	With Dual Colour End Caps	15W	White	Warm White	3000K	1360lm

LED SHAVER LIGHT WITH DUAL VOLTAGE SHAVER SOCKET

Construction: Polycarbonate

Driver: Included

Lamp type: LED



Width	Height	Projection	(mm)
494	60	70	

Code	Wattage	Finish	Colour	CCT	Lumens
SLIGHT2	6W	White	Warm White	3000K	450lm

LED SHAVER LIGHT WITH DUAL USB CHARGER

Construction: Polycarbonate

Driver: Included

Lamp type: LED

ARRIVING
Q4 2020



Width	Height	Projection	(mm)
492	60	70	

Code	Wattage	Finish	Colour	CCT	Lumens
SL6USBW	6W	White	Warm White	3000K	500lm NEW
SL6USBC	6W	Chrome	Warm White	3000K	500lm NEW



LED SHAVER LIGHT WITH CONCEALED DUAL VOLTAGE SHAVER SOCKETS

Construction: Aluminium & polycarbonate

Driver: Integral

Lamp type: LED

Width	Height	Projection	(mm)
492	59	66	

Code	Wattage	Finish	Colour	CCT	Lumens
BWLED6	10W	Chrome	Warm White	3000K	800lm
BWLED7	10W	White	Warm White	3000K	800lm

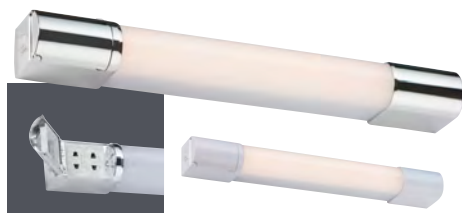

230V
50Hz

IP44

IP21
SHAVER
SOCKET



LED SHAVER LIGHT WITH 230V SHAVER SOCKET AND USB PORT

- Shaver socket and 5V DC 2A output
- USB port works independently from the light
- Pull cord switch fitted for independent light switching
- Maximum 2kg weight on glass shelf

Construction: Aluminium & polycarbonate

Driver: Included

Lamp type: LED

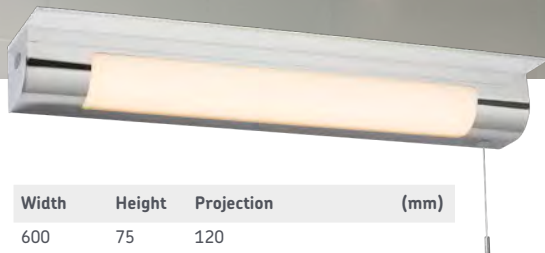

Width	Height	Projection	(mm)
600	75	120	

Code	Wattage	Finish	Colour	CCT	Lumens
SLULED	11W	Chrome	Warm White	3000K	765lm

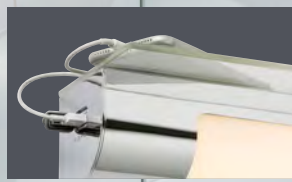

230V
50Hz

IP44



LED WALL-MOUNTED MIRROR / CABINET LIGHT

Construction: Aluminium & polycarbonate

Driver: Integral

Lamp type: LED

Width	Height	Projection	(mm)
400	41	121	

Code	Wattage	Colour	CCT	Lumens
BWLED1	8W	Warm White	3000K	650lm



LED WALL-MOUNTED MIRROR / CABINET LIGHT

Construction: Aluminium & polycarbonate

Driver: Integral

Lamp type: LED

Width	Height	Projection	(mm)
400	44	134	

Code	Wattage	Finish	Colour	CCT	Lumens
BWLED2	8W	Polished Chrome Effect	Warm White	3000K	650lm



LED OVER MIRROR / CABINET LIGHT

- Modern and lightweight design, ideal for above a mirror or cabinet within zones 2 and 3 in the bathroom.
- Robust, polycarbonate material

Construction: polycarbonate

Driver: Integral

Lamp type: LED



Width	Height	Projection	(mm)
400	53	116	

Code	Wattage	Finish	Colour	CCT	Lumens
BWLED10	6W	Chrome	Warm White	3000K	610lm





VANITY MIRROR

Construction: Pressed steel

Driver: Included

Lamp type: LED

Width	Projection	Base Ø	Overall Ø	(mm)	
333	270	110	200		
Code	Wattage	Finish	Colour	CCT	Lumens
VML1	3W	Chrome	Warm White	3000K	60lm

230V 50Hz	IP44	
 LAMP INCLUDED	3 YEAR WARRANTY	

T8 BATHROOM MIRROR WITH DUAL VOLTAGE SHAVER SOCKET

- Complete with pull cord switch

Construction: Steel & glass

HF Electronic Ballast: Included

Lamp type: Fluorescent

Width	Height	Projection	Base	(mm)
390	500	60	W: 370 H: 490	

Code	Wattage	Colour	CCT	Lumens
RCTM2T8	2 x 15W	Cool White	4000K	300lm



LED BATHROOM MIRROR WITH DUAL VOLTAGE SHAVER SOCKET

- Complete with pull cord switch

Construction: Steel & glass

Driver: Included

Lamp type: LED

Width	Height	Projection	Base	(mm)
390	500	60	W: 370 H: 490	

Code	Wattage	Colour	CCT	Lumens
RCTM2LED	10W	Cool White	4000K	125lm



LED COLOUR CHANGING MIRROR

- Edge-lit, multicoloured LEDs enhance the ambience or mood and look perfect over a vanity unit or basin
- Supplied with remote control with memory function

Construction: Aluminium & glass

Driver: Included

Lamp type: LED

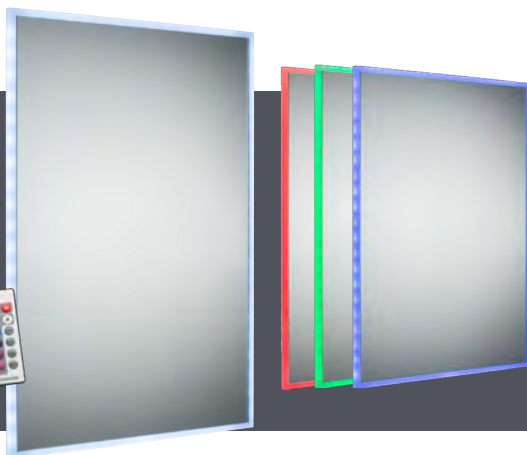

Width	Height	Projection	(mm)
500	700	40	

Code	Wattage	Colour
RCTRGB	18W	RGB





BATHROOM DOWNLIGHTS

Construction: Die-cast aluminium

Driver: Not required



- 230V IP65 GU10 range of recessed bathroom downlights
- Manufactured from die-cast aluminium
- Supplied complete with pre-wired GU10 230V lampholder
- Designed for use in bathrooms and shower cubicles etc.
- LED compatible (35W max.)

Bezel	Minimum Void	Recessed Depth	Cut-out	(mm)
84	140	90	64	

Code	Finish
RDSHC	Chrome
RDSHCBR	Brushed Chrome
RDSHW	White



BATHROOM WALL / SHELF LIGHTS

- Comes with three interchangeable chrome-effect heads
- Perfect for creating ambient effects in bathrooms

Construction: Stainless steel & polycarbonate

Driver: Included

Lamp type: LED

Recessed Depth	Overall Ø	Cut out	(mm)
48	38	32	

Code	Wattage	Finish	Colour	CCT	Lumens
LEDM06B	0.6W	Brushed Nickel	Blue	-	-
LEDM06W	0.6W	Brushed Nickel	White	6000K	50lm





BT14CT

See page 297 for IP65 LED Bulkheads

8300BC

See page 144 for Bathroom Pull Cord switches

LEDFIPWW

See page 232 for IP68 LED Flex

LOOKING FOR SOMETHING DIFFERENT FOR YOUR BATHROOM?

BATHROOM ZONE GUIDE



Bathroom luminaire installations must comply with legislation. This has recently been updated and is now Section 701 of BS7671 : 2018 (Wiring Regulations 18th Edition)

Zone 0 is inside the bath or shower itself. Any fitting used in this zone must be IP67 low voltage (max 12V).

Zone 1 is the area above the bath to a height of 2.25m from the floor. In this zone a minimum rating of IP44 is required.

Zone 2 is an area stretching 0.6m outside the perimeter of the bath and to a height of 2.25m from the floor. In this zone an IP rating of at least IP44 is required (except for shaver sockets located where direct spray is unlikely). In addition, it is good practice to consider the area around a wash basin (within a 60cm radius of any tap) as Zone 2.

Outside zones is anywhere outside zones 0, 1 and 2 (subject to specific limits) and where no water jet is likely to be used. No IP rating is required.

In addition to the above, if there is a likelihood of water jets being used for cleaning purposes in zones 1, 2 and "Outside Zones" a fitting rated a minimum IP65 must be used.

A 30mA residual current device (RCD) must also be used to protect all circuits supplying the location. Full details can be found in the latest copy of IEE wiring regulations.



DOMESTIC INTERIOR UNDER CABINET LIGHTING

Under cabinet lighting creates the perfect glow on kitchen worktops, providing discreet but effective illumination

Striplights

LED Linkable Striplights	219
LED Linkable Striplights with Sensor	220
24V LED Linkable Striplights & Accessories	221
Flat and Triangular LED Striplights & Accessories	222-223

Under Cabinet Lights

Mains Voltage Under Cabinet Lights	224
12V Under Cabinet Lights	225
LED Dimmable Under Cabinet Lights	226



Ultra-slim LED striplights, ideal for kitchen lighting, cabinet lighting, cove lighting, and retail applications. Linkable end-to-end by a coupler (included) or using link leads (available separately). Up to a maximum of 12 units can be interlinked to each other

- Integral driver, independently switched
- Energy efficient and long life
- Emits an even light distribution
- Versatile and simple to install
- Mountable horizontally or vertically
- Fixing kit supplied

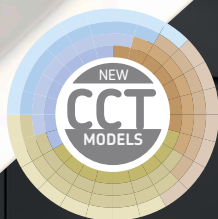

VERTICAL AND HORIZONTAL FIXINGS INCLUDED



CONNECTION COVER



Supplied with 2m power cord, small coupler connector, and fixing clips

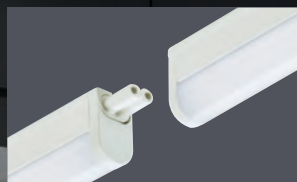

LINKABLE

LED LINKABLE STRIPLIGHTS

Construction: Polycarbonate

Driver: Integral

Lamp type: LED



Width	Projection	(mm)
22.8	36	

Code	Wattage	Colour	CCT	Length	Lumens	Qty
UCLED4WW	4W	Warm White	3000K	277mm	310lm	1
UCLED7WW	7W	Warm White	3000K	395mm	530lm	1
UCLED9WW	9W	Warm White	3000K	538mm	640lm	1
UCLED13WW	13W	Warm White	3000K	838mm	950lm	1
UCLED18WW	18W	Warm White	3000K	1138mm	1450lm	1
UCLED22WW	22W	Warm White	3000K	1438mm	1550lm	1
UCLED4CW	4W	Cool White	4000K	277mm	360lm	1
UCLED7CW	7W	Cool White	4000K	395mm	570lm	1
UCLED9CW	9W	Cool White	4000K	538mm	760lm	1
UCLED13CW	13W	Cool White	4000K	838mm	1020lm	1
UCLED18CW	18W	Cool White	4000K	1138mm	1550lm	1
UCLED22CW	22W	Cool White	4000K	1438mm	1730lm	1

CCT ADJUSTABLE LED LINKABLE STRIPLIGHTS

Code	Wattage	Colour	CCT	Length	Lumens	Qty
UCLCT4	4W	CCT	3000/4000/6500K	277mm	350/390/370lm	1 NEW
UCLCT9	9W	CCT	3000/4000/6500K	538mm	685/690/675lm	1 NEW
UCLCT13	13W	CCT	3000/4000/6500K	838mm	1055/1055/1025lm	1 NEW
UCLCT18	18W	CCT	3000/4000/6500K	1138mm	1675/1915/1780lm	1 NEW

ACCESSORIES

Code	Model	Length
UC250	Link Power Cord	250mm
UC500	Link Power Cord	500mm
UC1000	Link Power Cord	1000mm
UCP200	Power Cable	2000mm
UCCUP	Coupler / Connector	





LED MAINS VOLTAGE LINKABLE STRIPLIGHT WITH ON/OFF MOTION SENSOR

Slim low-profile design with integrated LED driver, constructed from aluminium and polycarbonate. Produces an even light distribution. Ideal applications: under cabinets, kitchens, bedrooms, and wardrobes etc.

- Supplied with 2m power cord and fixings
- A maximum of 15 units can be linked together using optional link lead (not included)

Construction: Aluminium & Polycarbonate

Driver: Integral

Lamp type: LED

Width	Height	(mm)
60	28	



Code	Wattage	Colour	CCT	Length	Lumens
USLED73K	7W	Warm White	3000K	362mm	490lm
USLED123K	12W	Warm White	3000K	562mm	740lm
USLED7	7W	Cool White	4000K	362mm	500lm
USLED12	12W	Cool White	4000K	562mm	780lm

ACCESSORIES

Code	Model	Length
UC250	Link Power Cord	250mm
UC500	Link Power Cord	500mm
UC1000	Link Power Cord	1000mm
UCCUP	Coupler / Connector	





24V LED LINKABLE UNDER CABINET LIGHTS

- Tilt design
- Linkable via accessories
- Dimmable accessory available



Construction: Aluminium & Polycarbonate

Driver: Required - **24VDCA** (12W), **24DC36** (36W) or **24DC40** (40W) - see page 375

Lamp type: LED



Width	Projection	(mm)
33	9.5	

24V

IP20

LAMP INCLUDED

3 YEAR WARRANTY

Code	Wattage	Colour	CCT	Length	Lumens
UCL4WW	4W	Warm White	3000K	305mm	330lm
UCL6WW	6W	Warm White	3000K	505mm	430lm
UCL12WW	12W	Warm White	3000K	1005mm	820lm
UCL4CW	4W	Cool White	4000K	305mm	320lm
UCL6CW	6W	Cool White	4000K	505mm	430lm
UCL12CW	12W	Cool White	4000K	1005mm	800lm

PIR MOTION SENSOR



- Tilt design
- 120° field of detection
- Time adjustable from 30 seconds to 3 minutes

Code	Model
UCL0S	24V Plug-in Adjustable Motion Sensor

TOUCH DIMMER



- Controls all the connected fittings in a series (36W max.)
- Memory function included, unit will save last setting

Code	Model
UCLTD	24V Touch Dimmer
LEDDIMMERW	White LED Dimmer

CONNECTOR BLOCK / COUPLER

- End feed power connector for direct wiring from remote driver
- Coupler for connecting two UCL fittings



Code	Model
UCLJB	Plug-in Rewireable Connector
UCL0E	24V 1m Connector Cable (open end)

Code	Model
UCLCB	24V 1m Connector Cable (plug to plug)
UCLCP	Coupler for UCL Series



FLAT LED STRIPLIGHTS

- Supplied with coupler, 1m power cord, and fixing kit

Construction: Extruded Aluminium

Lamp type: LED

Driver: Required (LEDAD36)

Width	Projection	(mm)
33	8	



Code	Wattage	Colour	CCT	Length	Lumens
LED3WWW	3W	Warm White	3000K	310mm	395lm
LED5WWW	5W	Warm White	3000K	510mm	625lm
LED11WWW	11W	Warm White	3000K	1010mm	1325lm
LED3WCW	3W	Cool White	6000K	310mm	385lm
LED5WCW	5W	Cool White	6000K	510mm	580lm
LED11WCW	11W	Cool White	6000K	1010mm	1320lm
LED3WB	3W	Blue	-	310mm	-
LED5WB	5W	Blue	-	510mm	-
LED11WB	11W	Blue	-	1010mm	-

FLAT STRIPLIGHT ESSENTIALS

Code	Model
LEDFLIP	Metal Mounting Clip (with 2 x Screws)
LEDFCN	PVC Connector
LEDTD1	Touch Dimmer
LEDTD2	DC 24V Plug in Power Connector
LEDRACON	PVC Right Angle Connector



TRIANGULAR LED STRIPLIGHTS

- Supplied with coupler, 1m power cord, and fixing kit

Construction: Extruded Aluminium

Lamp type: LED

Driver: Required (LEDAD36)

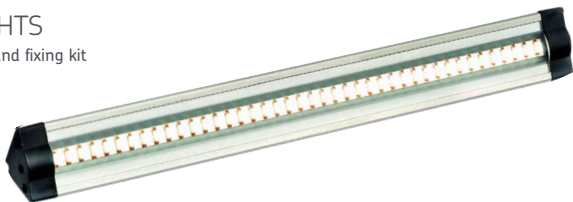

Width	Projection	(mm)
33	20	



Code	Wattage	Colour	CCT	Length	Lumens
LEDT3WWW	3W	Warm White	3000K	300mm	395lm
LEDT5WWW	5W	Warm White	3000K	500mm	625lm
LEDT11WWW	11W	Warm White	3000K	1000mm	1325lm
LEDT3WCW	3W	Cool White	6000K	300mm	385lm
LEDT5WCW	5W	Cool White	6000K	500mm	580lm
LEDT11WCW	11W	Cool White	6000K	1000mm	1320lm

TRIANGULAR STRIPLIGHT ESSENTIALS

Code	Model
LEDTCLIP	Metal Mounting Clip (with 2 x Screws)
LEDTCON	PVC Connector



LEDTCLIP



LEDTCON

FLAT AND TRIANGULAR STRIPLIGHT ESSENTIALS

Code	Model
LEDDIMMER	LED Dimmer
LEDAD36	36W Power Adaptor - Black NEW
LEDAD36W	36W Power Adaptor - White NEW
LED8SPLIT	PVC DC 8-Way Splitter



LEDDIMMER



LEDAD36



LEDAD6W

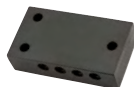

LED8SPLIT

POWER LEADS

- Use to connect additional linear striplights

Code	Length
LED100	100mm
LED250	250mm
LED1000	1000mm
LED2500	2500mm



LED100



LED1000



LED UNDER CABINET LIGHTS

- Suitable for surface or recessed mounting
- Supplied with 1.2m cable

Construction: Pressed Steel

Driver: Integral

Lamp type: LED



Projection	Diameter	Cut-out	(mm)
30	71	58	



Code	Wattage	Colour	CCT	Finish	Lumens
CABBCWW	2W	Warm White	3000K	Brushed Chrome	125lm
CABCWW	2W	Warm White	3000K	Chrome	125lm
CABWWW	2W	Warm White	3000K	White	125lm
CABBCW	2W	Cool White	4000K	Brushed Chrome	140lm
CABCCW	2W	Cool White	4000K	Chrome	140lm
CABWCW	2W	Cool White	4000K	White	140lm

TRIANGULAR LED UNDER CABINET LIGHTS

Construction: Pressed Steel

Driver: Integral

Lamp type: LED



Width	Projection	(mm)
128	40	



Code	Wattage	Colour	CCT	Lumens
TRIBCWW	2W	Warm White	3000K	125lm
TRIBCCW	2W	Cool White	4000K	140lm

12V UNDER CABINET LIGHTS

- Suitable for surface and recessed mounting

Construction: Pressed steel

Driver: 12V AC transformer required (T02)

Lamp type: 12V G4 10W & 20W Halogen included



Projection	Diameter	Cut-out	(mm)
25	72	60	



Code	Model
CRF02B	Brass
CRF02C	Chrome

Code	Model
CRF02CBR	Brushed Chrome
CRF02W	White



LEDREC

12V LED UNDER CABINET LIGHTS

- Prewired with 1.5m cable

Construction: Pressed Steel

Driver: Required (12VDCA)

Lamp type: LED



LEDTRI



Code	Width	Height	Model	Wattage	Colour	CCT	Lumens
LEDREC	86mm	55mm	Rectangular	3W	Cool White	4000K	90lm
LEDTRI	130mm	48mm	Triangular	3W	Cool White	4000K	95lm



RECESS
MOUNTED

SURFACE
MOUNTED



LED DIMMABLE UNDER CABINET LIGHTS

Stylish, low profile, under-cabinet LED kit. Supplied complete with 3 lights, 6-way connector, and a dimmable LED remote driver.

- Users can add additional lights (up to 6 per driver)
- Suitable for surface and recessed mounting
- Pre-wired with 2.5m cable
- Available as single lights, as well as packs of 3

Construction: Polycarbonate

Driver: Included with kits (not included with single lights)

Lamp type: LED



Diameter	Projection	Cut-out Ø (mm)
68	11	63



LED UNDER CABINET LIGHTING KITS

Code	Wattage	Finish	Colour	CCT	Lumens	
UNDKIT3WWW	3 x 2.5W	White	Warm White	3000K	195lm	NEW
UNDKIT3BCWW	3 x 2.5W	Brushed Chrome	Warm White	3000K	185lm	NEW
UNDKIT3WCW	3 x 2.5W	White	Cool White	4000K	225lm	NEW
UNDKIT3BCCW	3 x 2.5W	Brushed Chrome	Cool White	4000K	220lm	NEW

LED UNDER CABINET LIGHTS (SINGLE)

Code	Wattage	Finish	Colour	CCT	Lumens	
UNDK3WWW	2.5W	White	Warm White	3000K	195lm	NEW
UNDK3BCWW	2.5W	Brushed Chrome	Warm White	3000K	185lm	NEW
UNDK3WCW	2.5W	White	Cool White	4000K	225lm	NEW
UNDK3BCCW	2.5W	Brushed Chrome	Cool White	4000K	220lm	NEW

UNDKIT 6-WAY CONNECTOR

Code	Model	
UNDKCON	6-Way Connector	NEW



ARRIVING
Q4 2020

We're only a click away.

K-Direct is a quick and reliable home delivery service that provides next day delivery (across mainland UK) with a no-minimum order value or quantity. Simply place your customer's order online and have it delivered direct on your behalf. Cut out the time spent double handling and order exactly what you want without having to order minimum product quantities. Don't let logistics stand in the way of you and our fantastic products - order with K-Direct and ensure a professional, fast and efficient delivery service.

Our responsive website ensures, however you access our products, your experience is quick and hassle free.

 **K**direct
**Quality products,
 first class delivery**

- A quick and reliable home delivery service
- Shipping direct to your customers on **YOUR** behalf
- In excess of 3000 product lines in stock now
- Quality which is not compromised, MLA is renowned for a 1st class customer service experience
- No minimum box quantities*
- No minimum order value
- Reduces commitment to stock
- No double handling
- Next day delivery across mainland UK
- Fast, efficient and professional
- Created for our wholesalers to satisfy their customers

* Exceptions apply to fragile items

Place your customers order online and have it delivered direct on your behalf



LED FLEX

Extremely versatile and adaptable, LED Flex can be used to create stunning ambient lighting effects across a wide range of applications

Single Colour LED Flex	230
Colour-Changing / CCT Adjustable LED Flex	231
IP68 LED Flex	232
Bendable / High Lumen LED Flex	233
Aluminium Profiles	234
LED Flex Remotes and Controllers	235
LED Flex Connectors / Fixing Kit	236
LED Flex Drivers and Amplifiers	237
LED Flex Part Chart	238-239



12V IP20 SINGLE COLOUR LED FLEX

- Dimmable when using **LEDFR1** and **LEDFR7** remote control unit, or when using constant voltage dimmable drivers (not included)

Driver: Required

Compatible remotes: **LEDFR1** or **LEDFR7**



Code	Watts/mtr	LEDs/mtr	Colour	CCT	Width	Length	Lumens/mtr
LEDFN212WW	4.8W	60	Warm White	3000K	8mm	2m	590lm
LEDFN212DL	4.8W	60	Daylight	6500K	8mm	2m	620lm
LEDFN12WW	4.8W	60	Warm White	3000K	8mm	5m	590lm
LEDFN12CW	4.8W	60	Cool White	4000K	8mm	5m	590lm NEW
LEDFN12DL	4.8W	60	Daylight	6500K	8mm	5m	620lm
LEDFN12B	4.8W	60	Blue	-	8mm	5m	-
LEDFN12G	4.8W	60	Green	-	8mm	5m	-
LEDFN12R	4.8W	60	Red	-	8mm	5m	-

24V IP20 SINGLE COLOUR LED FLEX

- Dimmable when using **LEDFR1** and **LEDFR7** remote control unit, or when using constant voltage dimmable drivers (not included)

Driver: Required

Compatible remotes: **LEDFR1** or **LEDFR7**



Code	Watts/mtr	LEDs/mtr	Colour	CCT	Width	Length	Lumens/mtr
LEDFN24WW	4.8W	60	Warm White	3000K	8mm	20m	590lm
LEDFN24DL	4.8W	60	Daylight	6500K	8mm	20m	620lm



12V IP20 COLOUR-CHANGING LED FLEX

- Preset with a variety of chasing modes
- Fully controllable via **LEDFR3** remote control unit (not included)

Driver: Required

Compatible remotes: **LEDFR3**



Code	Watts/mtr	LEDs/mtr	Colour	Width	Length
LEDF12CHS	9.2W	30	RGB ● ● ● ● ● ●	10mm	5m

24V IP20 COLOUR-CHANGING LED FLEX

- Colour and temperature changing LED flex is the perfect way to be creative with your environment
- Fully controllable with a selection of remote control units (not included)

Driver: Required

Compatible remotes: See table below



Code	Watts/mtr	LEDs/mtr	Colour	Width	Length	Compatible Remote
LEDF24RGB	7.2W	30	RGB ● ● ● ● ● ●	10mm	5m	LEDFR4 or LEDFR5
LEDF24RGBW	9W	30	RGBW ● ● ● ● ● ○	12mm	5m	LEDFR6

24V IP20 CCT ADJUSTABLE LED FLEX

- Colour temperature adjustable, Warm White 3000K to Daylight 6000K
- Fully controllable with a selection of remote units (not included)

Driver: Required

Compatible remotes: **LEDFR2** or **LEDFR8**



Code	Watts/mtr	LEDs/mtr	Colour	Width	Length
LEDF24CCT	12W	60	CCT Adjustable ● ●	10mm	5m



24V IP68 SINGLE COLOUR LED FLEX

- Silicone encapsulated IP68 LED Flex, ideal for exterior use
- Dimmable when using **LEDFR7** remote control unit, or when using constant voltage dimmable drivers (not included)

Driver: Required

Compatible remote: LEDFR7



Code	Watts/mtr	LEDs/mtr	Colour	CCT	Width	Length	Lumens/mtr
LEDFIPWW	4.8W	60	Warm White	3000K	10mm	5m	560lm
LEDFIPDL	4.8W	60	Daylight	6500K	10mm	5m	590lm

24V IP68 COLOUR-CHANGING LED FLEX

- Silicone encapsulated IP68 LED Flex, ideal for exterior use
- Fully controllable with a selection of remote control units (not included)

Driver: Required

Compatible remotes: See table below

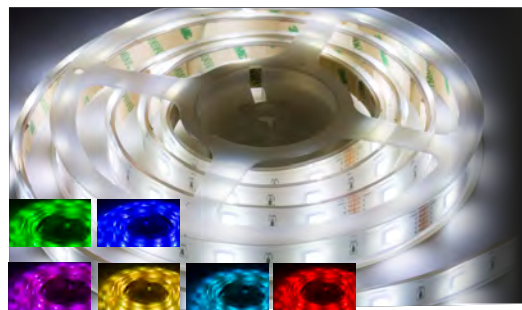

Code	Watts/mtr	LEDs/mtr	Colour	Width	Length	Compatible Remote
LEDFIPRGB	7.2W	30	RGB ● ● ● ● ● ●	12.5mm	5m	LEDFR5
LEDFIPRGBW	9W	30	RGBW ● ● ● ● ● ○	14.5mm	5m	LEDFR6

24V IP68 CCT ADJUSTABLE LED FLEX

- Silicone encapsulated IP68 LED Flex, ideal for exterior use
- Colour temperature adjustable, Warm White 3000K to Daylight 6000K

Driver: Required

Compatible remotes: LEDFR8



Code	Watts/mtr	LEDs/mtr	Colour	Width	Length
LEDFIPCCT	12W	60	CCT Adjustable ● ●	12.5mm	5m

12V IP20 BENDABLE LED FLEX

- IP20 wavy LED Flex, with a highly pliable s-shaped PCB
- Enables easy installation around bends and corners and is ideal for channel letter lighting
- Dimmable when using **LEDFR1** and **LEDFR7** remote control unit, or when using constant voltage dimmable drivers (not included)

Driver: Required

Compatible Remotes: **LEDFR1** or **LEDFR7**



Code	Watts/mtr	LEDs/mtr	Colour	CCT	Width	Height	Lumens/mtr
LEDFS12WW	5W	60	Warm White	3000K	8mm	5m	590lm
LEDFS12DL	5W	60	Daylight	6500K	8mm	5m	610lm

24V IP20 HIGH LUMEN LED FLEX

- High output LED Flex, available in warm white and daylight options
- 120 LEDs per metre producing an extremely high lumen output
- Dimmable when using **LEDFR1** and **LEDFR7** remote control unit, or when using constant voltage dimmable drivers (not included)

Driver: Required

Compatible Remotes: **LEDFR1** or **LEDFR7**



Code	Watts/mtr	LEDs/mtr	Colour	CCT	Width	Length	Lumens/mtr
LEDFH24WW	14W	120	Warm White	3000K	8mm	5m	1160lm
LEDFH24DL	14W	120	Daylight	6500K	8mm	5m	1250lm



ALUMINIUM PROFILES

- Compatible with our full range of IP20 single colour, CCT, and RGB Flex
- Maximum flex width 10mm

Code	Model	Width	Height	Recessed Depth	Length
1MPSC	Surface Mount Corner	18mm	18mm		1m
1MPRF	Recessed Flat	25mm	2.5mm	5.5mm	1m
1MPSF	Surface Mount Flat	18mm	10mm		1m



LED FLEX REMOTES AND CONTROLLERS

A selection of remotes and controllers for use with Knightsbridge LED Flex, ranging from basic button remotes to touch panel remotes for an extensive range of dimming colour controls

Code	Model	12V	24V
LEDFR1	12V / 24V Inline RF Controller and Remote - Dimmer Single Colour	72W	144W
LEDFR2	12V / 24V IR Controller and Remote - CCT	72W	144W
LEDFR3	12V IR Controller and Remote - RGB Chaser	72W	-
LEDFR4	12V / 24V IR Controller and Remote - RGB	72W	144W
LEDFR5	12V / 24V RF Touch Controller and Remote - RGB	216W	432W
LEDFR6	12V / 24V RF Touch Controller and Remote - RGBW	288W	576W
LEDFR7	12V / 24V RF Controller and Touch Remote - Dimmer Single Colour	216W	432W
LEDFR8	12V / 24V RF Controller and Touch Remote - CCT	144W	288W



VISIT
SMART HOME
on pages 164-169



SMART LED FLEX CONTROLLER

- Compatible with single colour, CCT, RGB, and RGBW Flex
- Enables users to adjust the colour temperature of their LED Flex via the Smartknight app
- RGB and RGB LED Flex only: enables users to adjust the RGB colour, with over 16 million colour options, via the Smartknight app

Code	Model	
LEDWFIFI	12V / 24V	NEW



SINGLE COLOUR LED FLEX SOLDERLESS CONNECTORS (12V AND 24V)

- For 8mm 12V and 24V single colour LED Flex

Code	Model
CONSS2P	Strip-to-Strip Connector - Single Colour
CON2P	Connectors (Pack of 2) - Single Colour
CON2P	3-Way Connector - Single Colour
CONX2P	4-Way Connector - Single Colour

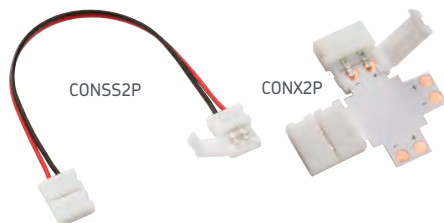

LED FLEX CONNECTORS

- Strip-to-strip solderless connectors
- For 12V and 24V LED Flex



Code	Model
CONFLEX2P	Strip-to-Strip Connector - Single Colour
CONFLEX3P	Strip-to-Strip Connector - CCT
CONFLEX4P	Strip-to-Strip Connector - RGB
CONFLEX5P	Strip-to-Strip Connector - RGBW
CONFLEXCHS	Strip-to-Strip Connector - RGB Chaser

IP20 12V/24V FLEX CONNECTOR



Code	Model
CENCONF	12V / 24V 8mm Single Colour Connector
FLEXCON	12 / 24V 8mm Single Colour Male and Female Connector

IP20 12V/24V END POWER CONNECTOR



Code	Model
CENCONS	12V / 24V 8mm Single Colour Power Connector

FIXING KIT

- Fixing Kit for IP68 LED Flex (5 clips per pack)



Code	Model
FLEXFIX	IP68 Mounting Kit - Single Colour
FLEXFIXL	IP68 Mounting Kit - CCT/RGB/RGBW

IP68 LED FLEX CONNECTORS

- Supplied with 1 male and 1 female connector, 4 x end caps and 10ml glue for sealing

Code	Model
CONIP2P	12V/24V IP Connector - Single Colour
CONIP3P	12V/24V IP Connector - CCT
CONIP4P	12V/24V IP Connector - RGB
CONIP5P	12V/24V IP Connector - RGBW





AMPLIFIERS

- Signal Amplifier - 12V and 24V compatible
- Enables LED Flex to be extended but continues to use one source of control
- Prevents voltage and signal drop

Code	Model
LEDAMP	LED Amplifier
RGBAMP	RGB Amplifier



IP20 24V LED CONSTANT VOLTAGE DRIVERS

Code	Model
24VDCA	24V 12W
24DC36	24V 36W
24DC40	24V 40W
24DC60	24V 60W



IP20 LED DIMMABLE CONSTANT VOLTAGE DRIVERS

- Compatible with most trailing-edge dimmers

Code	Model
12DC25D	12V 25W
24DC25D	24V 25W
12DC50D	12V 50W
24DC50D	24V 50W
24DC100D	24V 100W



IP20 12V LED CONSTANT VOLTAGE DRIVERS

Code	Model
12VDCA	12V 12W
12DC36	12V 36W
12DC40	12V 40W
12DC60	12V 60W



IP20 24V LED CONSTANT VOLTAGE DRIVERS

Code	Model
24DC100A	24V 100W
24DC150A	24V 150W
24DC200A	24V 200W



IP67 CONSTANT VOLTAGE DRIVERS

Code	Model
12DCIP36	12V 36W
24DCIP36	24V 36W
24DCIP60	24V 60W
24DCIP100	24V 100W



LED FLEX PART CHART

PRODUCT CODE	DESCRIPTION	VOLTAGE / IP / LENGTH	WATTAGE PER METRE	2 METRES	5 METRES
LEDFN212WW	WARM WHITE	12V / IP20 / 2m	4.8W	12VDCA 12DC25D	12DC40 12DC50D
LEDFN212DL	DAYLIGHT	12V / IP20 / 2m	4.8W	12VDCA 12DC25D	12DC40 12DC50D
LEDFN12WW	WARM WHITE	12V / IP20 / 5m	4.8W	12VDCA 12DC25D	12DC40 12DC50D
LEDFN12CW	COOL WHITE	12V / IP20 / 5m	4.8W	12VDCA 12DC25D	12DC40 12DC50D
LEDFN12DL	DAYLIGHT	12V / IP20 / 5m	4.8W	12VDCA 12DC25D	12DC40 12DC50D
LEDFN12B	BLUE	12V / IP20 / 5m	4.8W	12VDCA 12DC25D	12DC40 12DC50D
LEDFN12G	GREEN	12V / IP20 / 5m	4.8W	12VDCA 12DC25D	12DC40 12DC50D
LEDFN12R	RED	12V / IP20 / 5m	4.8W	12VDCA 12DC25D	12DC40 12DC50D
LEDFS12WW	BENDABLE - WARM WHITE	12V / IP20 / 5m	5W	12VDCA 12DC25D	12DC40 12DC50D
LEDFS12DL	BENDABLE - DAYLIGHT	12V / IP20 / 5m	5W	12VDCA 12DC25D	12DC40 12DC50D
LEDF12CHS	RGB CHASER	12V / IP20 / 5m	9.2W	12DC40 12DC25D	12DC60 12DC50D
LEDFH24WW	HIGH LUMEN - WARM WHITE	24V / IP20 / 5m	14W	24DC40 24DC50D	24DC100A 24DC100D
LEDFH24DL	HIGH LUMEN - DAYLIGHT	24V / IP20 / 5m	14W	24DC40 24DC50D	24DC100A 24DC100D
LEDF24RGB	COLOUR CHANGING RGB	24V / IP20 / 5m	7.2W	24DC40 24DC25D	24DC40 24DC50D
LEDF24RGBW	COLOUR CHANGING RGB & WHITE	24V / IP20 / 5m	9W	24DC40 24DC25D	24DC60 24DC50D
LEDF24CCT	COLOUR TEMPERATURE CHANGING	24V / IP20 / 5m	12W	24DC40 24DC50D	24DC100A 24DC100D
LEDFN24WW	WARM WHITE	24V / IP20 / 20m	4.8W	24VDCA 24DC25D	24DC40 24DC50D
LEDFN24DL	DAYLIGHT	24V / IP20 / 20m	4.8W	24VDCA 24DC25D	24DC40 24DC50D
LEDFIPWW	WARM WHITE	24V / IP68 / 5m	4.8W	24DCIP36	24DCIP36
LEDFIPDL	DAYLIGHT	24V / IP68 / 5m	4.8W	24DCIP36	24DCIP36
LEDFIPRGB	COLOUR CHANGING RGB	24V / IP68 / 5m	7.2W	24DCIP36	24DCIP60
LEDFIPRGBW	COLOUR CHANGING RGB & WHITE	24V / IP68 / 5m	9W	24DCIP36	24DCIP60
LEDFIPCCT	COLOUR TEMPERATURE CHANGING	24V / IP68 / 5m	12W	24DCIP36	24DCIP100

The above chart is for basic guidance only when installing LED Flex using a single driver. Please contact us for any questions you may have regarding more complex installations.

10 METRES	15 METRES	20 METRES	COMPATIBLE CONTROL UNITS	COMPATIBLE CONNECTORS
12DC60	X	X	LEDFR1 - LEDFR7 LEDFWIFI	CONFLEX2P - CONSS2P - CON2P - CONT2P - CONX2P
12DC60	X	X	LEDFR1 - LEDFR7 LEDFWIFI	CONFLEX2P - CONSS2P - CON2P - CONT2P - CONX2P
12DC60	X	X	LEDFR1 - LEDFR7 LEDFWIFI	CONFLEX2P - CONSS2P - CON2P - CONT2P - CONX2P
12DC60	X	X	LEDFR1 - LEDFR7 LEDFWIFI	CONFLEX2P - CONSS2P - CON2P - CONT2P - CONX2P
12DC60	X	X	LEDFR1 - LEDFR7 LEDFWIFI	CONFLEX2P - CONSS2P - CON2P - CONT2P - CONX2P
12DC60	X	X	LEDFR1 - LEDFR7 LEDFWIFI	CONFLEX2P - CONSS2P - CON2P - CONT2P - CONX2P
12DC60	X	X	LEDFR1 - LEDFR7 LEDFWIFI	CONFLEX2P - CONSS2P - CON2P - CONT2P - CONX2P
12DC60	X	X	LEDFR1 - LEDFR7 LEDFWIFI	CONFLEX2P - CONSS2P - CON2P - CONT2P - CONX2P
12DC60	X	X	LEDFR1 - LEDFR7 LEDFWIFI	CONFLEX2P - CONSS2P - CON2P - CONT2P - CONX2P
X	X	X	LEDFR3	CONFLEXCHS
24DC150A	X	X	LEDFR7 - LEDFWIFI	CONFLEX2P - CONSS2P - CON2P - CONT2P - CONX2P
24DC150A	X	X	LEDFR7 - LEDFWIFI	CONFLEX2P - CONSS2P - CON2P - CONT2P - CONX2P
24DC100A 24DC100D	24DC150A	X	LEDFR4 - LEDFR5 LEDFWIFI	CONFLEX4P
24DC100A 24DC100D	X	X	LEDFR6 - LEDFWIFI	CONFLEX5P
24DC150A	X	X	LEDFR2 - LEDFR8 LEDFWIFI	CONFLEX3P
24DC60 24DC100D	24DC100A 24DC100D	24DC150A	LEDFR7 - LEDFWIFI	CONFLEX2P - CONSS2P - CON2P - CONT2P - CONX2P
24DC60 24DC100D	24DC100A 24DC100D	24DC150A	LEDFR7 - LEDFWIFI	CONFLEX2P - CONSS2P - CON2P - CONT2P - CONX2P
24DCIP60	24DCIP100	X	LEDFR7 - LEDFWIFI	CONIP2P
24DCIP60	24DCIP100	X	LEDFR7 - LEDFWIFI	CONIP2P
24DCIP100	X	X	LEDFR5 - LEDFWIFI	CONIP4P
24DCIP100	X	X	LEDFR6 - LEDFWIFI	CONIP5P
X	X	X	LEDFR8 - LEDFWIFI	CONIP3P



01582 88 77 60



mlaccessories.co.uk



OUTDOOR LIGHTING

OUTDOOR WALL LIGHTS

A comprehensive range of decorative wall lights, perfect for illuminating garden walkways and patios

IP54 LED Up/Down Wall Lights	243
IP65 Wall Lights	244
IP44 Wall Lights with PIR Sensor	245
IP65 Heavy Gauge Wall Lights / IP65 Ground Bollard	246
IP65 Mini Aluminium Wall Lights	247
IP44 Wall Lights / IP44 LED Guide Lights	248
IP54 Recessed LED Guide Lights	249
IP44 LED Wall/Guide Lights	250-251
IP65 Adjustable Up/Down Wall Lights	252
IP54 LED Round Interchangeable Wall Light	253
IP54 LED Bricklight / IP44 E27 Bricklight	254
IP44 Window/Slotted Wall Lights	255
IP33 Wall Lantern / IP44 Globe Wall Light	256
IP23 Stainless Steel Lanterns	257
IP54 LED Lanterns	258
IP54 GU10 Wall Light / IP54 E27 Wall Light	259
IP44 E27 Spike and Wall Lights	260

Note: Some of our outdoor products may not be suitable for use in coastal areas where salt corrosion is prevalent

KNOW YOUR IP RATING

IPXX

First digit

Indicates the level of protection against access to hazardous parts and the ingress of solid objects

1

>50mm

Protection against any large surface of the body, such as the back of a hand, but no protection against deliberate contact

2

>12.5mm

Protection against fingers or similar objects

3

>2.5mm

Protection against tools, thick wires, etc

4

>1mm

Protection against most wires, slender screws, large insects etc

5

Dust protected

Protection against dust that may harm equipment

6

Dust tight

No ingress of dust; complete protection against ingress

Second digit

Indicates the level of protection against the harmful ingress of water

1

Dripping water

Protection against vertical drops when mounted in an upright position onto a turntable and rotated at 1 RPM

2

Dripping water (tilted)

Protection against water droplets when tilted up to 15° from vertical

3

Spraying water

Protection against water spray from all up to an angle of 60 degrees

4

Splashing water

Protection against splashing water from any direction

5

Water jets

Protection against low pressure jets of water from any direction

6

Powerful Water jets

Protection against high pressure jets of water from any direction

Please note, IPX7 and IPX8 are tested using different methods from IPX6 and below. Products with IPX7 or IPX8 ratings are not necessarily protected from water jets or splashes

7

Immersion up to 1m

Protection from immersion in water under defined conditions of pressure and time

8

Immersion beyond 1m

Protection from immersion in water under defined conditions of pressure and time



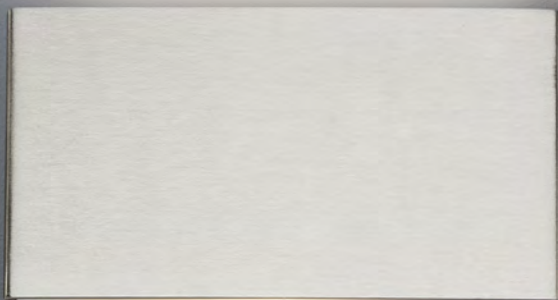

LED UP/DOWN WALL LIGHTS

- Provides a striking up/down lighting effect
- Ideal for both indoor and outdoor use: in porches, hallways, patio areas as well as offices and studio spaces

Height	Projection	(mm)
100	50	

Construction: 304 Stainless Steel
Driver: Integral
Lamp type: LED

230V
50Hz

IP54



3
YEAR
WARRANTY



Code	Wattage	Width	Finish	Colour	CCT	Lumens
WSS8A	2 x 4W	100mm	Anthracite	Warm White	3500K	450lm
WSS8BC	2 x 4W	100mm	Brushed Chrome	Warm White	3500K	450lm
WSS8W	2 x 4W	100mm	White	Warm White	3500K	450lm
WSM16A	2 x 8W	180mm	Anthracite	Warm White	3500K	880lm
WSM16BC	2 x 8W	180mm	Brushed Chrome	Warm White	3500K	880lm
WSM16W	2 x 8W	180mm	White	Warm White	3500K	880lm

Important: Some of our outdoor lighting products may not be suitable for use in coastal areas where salt corrosion is prevalent.



WALL1L WALL LIGHT

Construction: 304 Stainless Steel
(WALL1LBK: Die-cast Aluminium)
Lamp type: GU10 LED



Code	Finish	Height	Diameter	Base Ø	Projection
WALL1L	Stainless Steel	120mm	60mm	78mm	86mm
WALL1LBK	Black	112mm	64mm	78mm	94mm
WALL1LC	Copper Effect	120mm	60mm	78mm	86mm

WALL2L UP / DOWN WALL LIGHT

Construction: 304 Stainless Steel
(WALL2LBK: Die-cast Aluminium)
Lamp type: GU10 LED

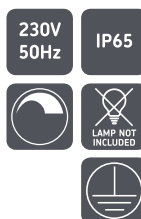

Code	Finish	Height	Diameter	Base Ø	Projection
WALL2L	Stainless Steel	162mm	60mm	78mm	86mm
WALL2LBK	Black	166mm	64mm	78mm	94mm
WALL2LC	Copper Effect	162mm	60mm	78mm	86mm

WALL3L WALL LIGHT

Construction: 304 Stainless Steel
(WALL3LBK: Die-cast Aluminium)
Lamp type: GU10 LED

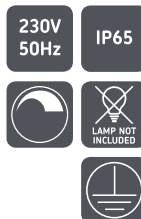

Code	Finish	Height	Diameter	Base Ø	Projection
WALL3L	Stainless Steel	140mm	60mm	78mm	155mm
WALL3LBK	Black	145mm	64mm	78mm	166mm
WALL3LC	Copper Effect	140mm	60mm	78mm	155mm



FOR MATCHING
SPIKE LIGHTS

SEE PAGE 264

Important: Some of our outdoor lighting products may not be suitable for use in coastal areas where salt corrosion is prevalent.

WALL4L UP/DOWN WALL LIGHT WITH PIR SENSOR

- Sensor detection range 8m when mounted at 2.4m
- PIR field of detection: 110°
- Includes manual override

Construction: 304 Stainless Steel

Lamp type: GU10 LED



Code	Finish	Height	Diameter	Projection
WALL4LSS	Stainless Steel	222mm	60mm	112mm



WALL5L WALL LIGHT WITH PIR SENSOR

- Sensor detection range 8m when mounted at 2.4m
- PIR field of detection: 110°
- Includes manual override

Construction: 304 Stainless Steel

Lamp type: GU10 LED



Code	Finish	Height	Diameter	Projection
WALL5LSS	Stainless Steel	184mm	60mm	112mm



Important:

Some of our outdoor lighting products may not be suitable for use in coastal areas where salt corrosion is prevalent.

WALL1



WALL3



WALL2



FOR MATCHING
SPIKE LIGHT

SEE PAGE 264



HEAVY GAUGE WALL LIGHTS

Construction: 304 Stainless Steel
Lamp type: GU10 LED

230V
50Hz

IP65



Code	Finish	Height	Diameter	Base	Projection
WALL1	Stainless Steel	108mm	62mm	76mm	92mm
WALL2	Stainless Steel	160mm	62mm	76mm	92mm
WALL3	Stainless Steel	140mm	62mm	76mm	162mm

GROUND BOLLARD

Construction: 304 Stainless Steel
Lamp type: GU10 LED

Code	Finish	Height
GROUND2	Stainless Steel	260mm

Important: Some of our outdoor lighting products may not be suitable for use in coastal areas where salt corrosion is prevalent.



230V
50Hz

IP65



MINI ALUMINIUM LED WALL LIGHTS

- Contemporary lightweight design, constructed with an aluminium body, suitable for indoor and outdoor use
- Compact sized outdoor lights with integral LED
- Energy efficient, low-maintenance and long-life

Construction: Aluminium
Driver: Integral
Lamp type: CoB LED



LWALL1A

LWALL2A

230V
50Hz

IP65



Overall Ø	Base Ø	Projection	(mm)
49	62	80	

Code	Wattage	Finish	Colour	CCT	Height	Lumens	
LWALL1A	4W	Brushed Chrome	Warm White	3000K	81mm	175lm	NEW
LWALL2A	2 x 4W	Brushed Chrome	Warm White	3000K	135mm	435lm	NEW

MINI ALUMINIUM LED ADJUSTABLE WALL LIGHT

Construction: Aluminium
Driver: Integral
Lamp type: CoB LED



230V
50Hz

IP65



Overall Ø	Base Ø	Projection	(mm)
49	62	139	

Code	Wattage	Finish	Colour	CCT	Lumens	
LWALL3A	4W	Brushed Chrome	Warm White	3000K	175lm	NEW



FOR MATCHING
SPIKE LIGHT

SEE PAGE 267



NH021W



NH022W

LED STAINLESS STEEL EXTERIOR WALL LIGHTS

Construction: 304 Stainless Steel

Driver: Integral

Lamp type: LED



Code	Wattage	Finish	Colour	CCT	Height	Width	Projection	Lumens
NH021W	2 x 3W	Stainless Steel	Cool White	4000K	147mm	60mm	95mm	30lm
NH022W	2 x 3W	Stainless Steel	Daylight	6000K	147mm	70mm	73mm	30lm



NH016W



NH017W

LED GUIDE / STAIR / WALL LIGHTS

Construction: Die-cast Aluminium

Driver: Integral

Lamp type: LED

Height	Width	Cut-out Ø	Recessed Depth	(mm)	230V 50Hz	IP44			
121	121	110	70						

Code	Wattage	Finish	Colour	CCT	Lumens
NH016W	0.8W	Grey	Daylight	6000K	23lm
NH017W	0.8W	Grey	Daylight	6000K	23lm



NH020W



NH020B



NH019W

WHITE / BLUE RECESSED LED GUIDE LIGHTS

Construction: Die-cast Aluminium

Driver: Integral

Lamp type: LED

Height	Width	Cut-out Ø	Recessed Depth	(mm)
80	80	75	50	



Code	Wattage	Finish	Colour	CCT	Lumens
NH020B	1W	Matt White	Blue	-	-
NH020W	1W	Matt White	Daylight	6000K	23lm
NH019W	1W	Matt White	Daylight	6000K	23lm

Important:

Some of our outdoor lighting products may not be suitable for use in coastal areas where salt corrosion is prevalent.



LWR4G

LWR2W

LWS4G

LWS2W

LED WALL / GUIDE LIGHTS

Construction: Aluminium

Driver: Integral

Lamp type: LED

230V
50Hz

IP44



Code	Shape	Wattage	Finish	Colour	CCT	Diameter	Projection	Lumens
LWR2G	Round	2W	Grey	Warm White	3500K	115mm	28mm	100lm
LWR2W	Round	2W	White	Warm White	3500K	115mm	28mm	100lm
LWR4G	Round	4W	Grey	Warm White	3500K	220mm	28mm	210lm
LWR4W	Round	4W	White	Warm White	3500K	220mm	28mm	210lm

Code	Shape	Wattage	Finish	Colour	CCT	Height	Width	Projection	Lumens
LWS2G	Square	2W	Grey	Warm White	3500K	105mm	105mm	28mm	100lm
LWS2W	Square	2W	White	Warm White	3500K	105mm	105mm	28mm	100lm
LWS4G	Square	4W	Grey	Warm White	3500K	200mm	200mm	28mm	200lm
LWS4W	Square	4W	White	Warm White	3500K	200mm	200mm	28mm	200lm



- Suitable for both indoor and outdoor applications
- Low maintenance
- Surface mounted for directional, focused, soft lighting



RWL2A

RWL5W

LED GUIDE LIGHTS

Construction: Aluminium

Driver: Integral

Lamp type: LED

230V
50Hz

IP54



Code	Wattage	Finish	Colour	CCT	Height	Width	Projection	Lumens
RWL2A	2W	Anthracite	Warm White	3500K	140mm	100mm	32mm	105lm
RWL2W	2W	White	Warm White	3500K	140mm	100mm	32mm	105lm
RWL5A	5W	Anthracite	Warm White	3500K	70mm	200mm	33mm	230lm
RWL5W	5W	White	Warm White	3500K	70mm	200mm	33mm	230lm

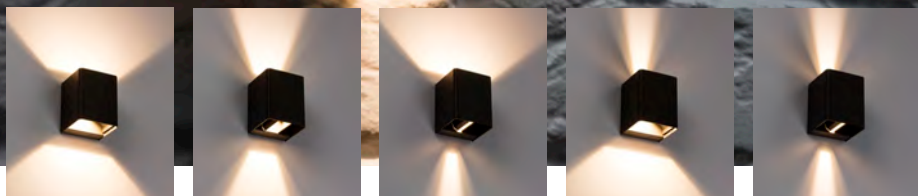

ADJUSTABLE UP / DOWN WALL LIGHTS

- Adjustable beam angle, from 0° to 100°
- Independently adjustable lighting effect

Construction: Die-cast Aluminium

Driver: Integral

Lamp type: CoB LED

Height	Width	Projection	(mm)
125	100	100	



Code	Wattage	Finish	Colour	CCT	Lumens	
WAD12A	2 x 6W	Anthracite	Warm White	3000K	2 x 330lm	NEW
WAD12BK	2 x 6W	Matt Black	Warm White	3000K	2 x 330lm	NEW



LED ROUND WALL LIGHT WITH INTERCHANGEABLE PLATE

- Supplied with 2 magnetic interchangeable plate options

Construction: Die-cast Aluminium

Driver: Integral

Lamp type: LED

Overall Ø	Projection	(mm)
155	48	



Code	Wattage	Finish	Colour	CCT	Lumens	
RD10BK	10W	Matt Black	Warm White	3000K	570lm	NEW



LED BRICKLIGHT

- Supplied complete with 2 fascia plates
- Plain and louver/grille

Construction: Aluminium

Driver: Integral

Lamp type: LED

Height	Length	Recessed Depth	Cut-out L/H/D (mm)
101	235	70	226 x 86 x 70



Code	Wattage	Finish	Colour	CCT	Lumens
BLED5BB	5W	Black	Blue	-	-
BLED5BW	5W	Black	Warm White	3500K	110lm
BLED5SB	5W	Brushed Steel	Blue	-	-
BLED5SW	5W	Brushed Steel	Warm White	3500K	110lm

E27 BRICKLIGHT

- Supplied complete with 2 fascia plates - plain and louver

Construction: Die-cast Aluminium

Driver: Not Required

Lamp type: E27 (40W max.)



Height	Length	Recessed Depth	Cut-out L/H/D (mm)
100	235	75	228 x 88 x 90



Code	Finish
BL01BK	Black



NH027



NH0285

STAINLESS STEEL EXTERIOR WALL LIGHTS

Construction: 201 Stainless Steel

Driver: Not Required

Lamp type: E27 (40W max.)

Height	Width	(mm)
276	205	



Code	Model	Finish	Projection
NH027	Window Fascia	Stainless Steel	90mm
NH027S	Window Fascia with PIR	Stainless Steel	96mm
NH028	Slotted Fascia	Stainless Steel	90mm
NH028S	Slotted Fascia with PIR	Stainless Steel	96mm

Important:

Some of our outdoor lighting products may not be suitable for use in coastal areas where salt corrosion is prevalent.



E27 WALL LANTERN

- Sensor detection range 5m when mounted at 1.5m
- Timer: 4 minutes
- No manual override

Construction: Die-cast Aluminium

Driver: Not Required

Lamp type: E27 (60W max.)

Height	Width	Projection	(mm)
365	165	98	

Code	Model	Finish
5401A	With PIR	Black



230V
50Hz

IP33



LAMP NOT INCLUDED



GLOBE WALL LIGHT

- Sensor detection range 8m when mounted at 1.5m
- Timer: 10 secs to 8 mins
- No manual override

Construction: Stainless Steel / Glass

Driver: Not Required

Lamp type: E27 (60W max.)

Overall Ø	Height	Projection	(mm)
200	425	275	

Code	Model	Finish
NH0112DS	With PIR	Brushed Chrome



230V
50Hz

IP44



LAMP NOT INCLUDED





STAINLESS STEEL LANTERN

- Stainless steel with clear glass
- Powder-coated finish
- LED compatible

Construction: 304 Stainless Steel

Driver: Not Required

Lamp type: E27 (40W max.)

Height	Width	Base	Projection (mm)
200	120	H: 100 W:78	150

230V
50Hz

IP23



Code	Finish
LANTBK	Anthracite
LANTSS	Brushed Chrome

EXTERIOR LED LANTERNS

- Durable, corrosion-resilient construction
- Low-maintenance, long-life and energy efficient
- Sensor detection angle 90° with manual override (PIR models)



Construction: Polycarbonate

Driver: Integral

Lamp type: LED

Height	Width	Base Ø	Projection (mm)
375	177	97	230



Code	Wattage	Model	Finish	Colour	CCT	Lumens
LANT1	8W	Standard	Black	Cool White	4000K	400lm
LANT1W	8W	Standard	White	Cool White	4000K	400lm
LANT2	8W	With PIR	Black	Cool White	4000K	400lm
LANT2W	8W	With PIR	White	Cool White	4000K	400lm

EXTERIOR LED HALF-LANTERNS

- Sensor detection angle 90° with manual override (PIR models)

Construction: Polycarbonate

Driver: Integral

Lamp type: LED



Height	Width	Projection (mm)
362	175	99



Code	Wattage	Model	Finish	Colour	CCT	Lumens
LANT3	8W	Standard	Black	Cool White	4000K	270lm
LANT3W	8W	Standard	White	Cool White	4000K	270lm
LANT4	8W	With PIR	Black	Cool White	4000K	270lm
LANT4W	8W	With PIR	White	Cool White	4000K	270lm

Important:

Some of our outdoor lighting products may not be suitable for use in coastal areas where salt corrosion is prevalent.

GU10 WALL LIGHT

Construction: 304 Stainless Steel

Driver: Not Required

Lamp type: GU10 LED

Diameter	Height	Projection (mm)
102	195	144

Code	Finish
GDL1	Anthracite

GDL1	Anthracite
------	------------

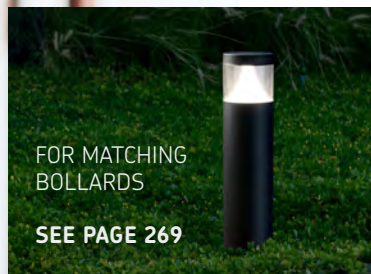

FOR MATCHING
BOLLARDS

SEE PAGE 269

E27 OUTDOOR WALL LIGHT

Construction: Die-cast Aluminium

Driver: Not Required

Lamp type: E27 (20W max.)

Height	Width	Projection (mm)
245	108	148

Code	Finish
OL01W	Black

OL01W	Black
-------	-------



FOR MATCHING
BOLLARDS

SEE PAGE 268



PAR38 SPIKE LIGHTS

Construction: Thermoplastic

Lamp type: E27 (80W max.)

Overall Ø	Height	Spike Length	(mm)
75	250	205	

Code	Model
1SPIKE38	1 X 80W Single Spike Light
2SPIKE38	2 X 80W Twin Spike Light



PAR38 WALL LIGHTS

Construction: Thermoplastic

Lamp type: E27 (80W max.)

Overall Ø	Base Ø	Projection	(mm)
75	98	225	

Code	Model
1WALL38	1 X 80W Single Wall Light
2WALL38	2 X 80W Twin Wall Light





Knightsbridge

Committed to a brighter future



At Knightsbridge, we believe in looking after our customers and looking after our planet. This philosophy is important to us and is why we have started to apply it to the way we package and present our products.

We are now working in conjunction with the FSC® moving towards 100% recyclable / 100% recycled packaging solutions. Look out for the FSC® label on our certified packaging.



This is our plan, this is our commitment to a brighter future.

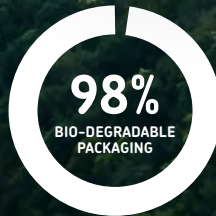

ENVIRONMENTALLY APPROPRIATE forest management ensures that the harvest of timber and non-timber products maintains the forest's biodiversity, productivity, and ecological processes.



SOCIALLY BENEFICIAL forest management helps both local people and society at large to enjoy long term benefits and also provides strong incentives to local people to sustain the forest resources and adhere to long-term management plans.



ECONOMICALLY VIABLE forest management means that forest operations are structured and managed so as to be sufficiently profitable, without generating financial profit at the expense of the forest resource, the ecosystem, or affected communities.



OUTDOOR LIGHTING

SPIKE LIGHTS

Spike lights are perfect for illuminating garden walkways, flower beds, water features and more. With picturesque results, these are an Instagram favourite!

GU10 Spike Lights

264-265

LED Spike Lights

266-267

Bollard & Post Lighting

268-269

Note: Some of our outdoor products may not be suitable for use in coastal areas where salt corrosion is prevalent



BLACK SPIKE LIGHT

- Supplied with 1.5m cable
- Supplied with wall mount and ground spike

Construction: Die-cast Aluminium

Driver: Not Required

Lamp type: GU10 LED

Overall Ø	Height	Spike Length	(mm)
65	330	173	

Code	Finish
SPIKEGUBK	Black

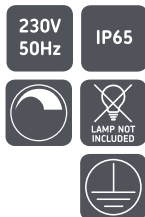

SPIKE LIGHTS

- Supplied with 3m cable

Construction: 304 Stainless Steel (GU10SPIKE) / Die-cast Aluminium (GU10SPIKEBK)

Driver: Not Required

Lamp type: GU10 LED

Overall Ø	Height	Spike Length	(mm)
63	250	120	

Code	Finish
GU10SPIKE	Stainless Steel
GU10SPIKEBK	Black



LIGHT GAUGE SPIKE LIGHT

- Supplied with 2m cable

Construction: 304 Stainless Steel

Driver: Not Required

Lamp type: GU10 LED

Overall Ø	Height	Spike Length	(mm)
60	250	120	

Code	Finish
GU10SPIKEL	Stainless Steel



GROUND SPIKE LIGHT

- Supplied with 2m cable

Construction: Die-cast Aluminium

Driver: Not Required

Lamp type: GU10 LED

Overall Ø	Height	Spike Length	(mm)
98	345	165	

Code	Finish
SPIKE50BL	Black

SPIKEXT Ground Spike - Black



EXTENSION SPIKES

Construction: Stainless Steel

Code	Finish	Height
EXT2	Stainless Steel	604mm
EXT3	Black	604mm



GROUND SPIKE LIGHT

- Wall-mountable option
- Supplied with 2m cable

Construction: Die-cast Aluminium / Spike - Polycarbonate

Driver: Not Required

Lamp type: GU10 LED (10W max.)

Overall Ø	Height	Spike Length	(mm)
98	326	170	

Code	Finish
GUSPBK	Black
GUSPGR	Grey

SPIKEXT1 Black



Important:

Some of our outdoor lighting products may not be suitable for use in coastal areas where salt corrosion is prevalent.



LED BLACK SPIKE LIGHT

- Supplied with 3m cable
- Supplied with wall mount and spike

Construction: Die-cast Aluminium

Lamp type: CoB LED

Overall Ø	Height	Spike Length	(mm)
60	305	173	

Code	Wattage	Finish	Colour	CCT	Lumens	
SPIKE4BL	4W	Black	Warm White	3000K	335lm	NEW



230V
50Hz

IP65



LED BLACK SPIKE LIGHT

- Supplied with 2m cable

Construction: 304 Stainless Steel Bezel, Die-cast Aluminium Body

Lamp type: CoB LED

Overall Ø	Height	Spike Length	(mm)
95	340	210	

Code	Wattage	Finish	Colour	CCT	Lumens	
SPIKE5A	6W	Black	Warm White	3000K	380lm	NEW



230V
50Hz

IP65





LED SPIKE LIGHT

- Supplied with 2m cable

Construction: 304 Stainless Steel

Lamp type: CoB LED

Overall Ø	Height	Spike Length	(mm)
63	255	110	

Code	Wattage	Finish	Colour	CCT	Lumens	
SPIKE5S	6W	Stainless Steel	Warm White	3000K	360lm	NEW

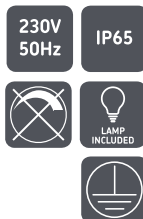

MINI ALUMINIUM LED SPIKE LIGHT

Construction: Aluminium

Lamp type: CoB LED

Overall Ø	Height	Spike Length	(mm)
49	227	110	

Code	Wattage	Finish	Colour	CCT	Lumens
LSPIKEA	4W	Brushed Chrome	Warm White	3000K	175lm

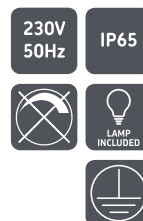

LED SPIKE LIGHT

- 350mA constant current driver required

Construction: 304 Stainless Steel

Driver: Required (see page 376)

Lamp type: CoB LED

Overall Ø	Height	Spike Length	(mm)
49	225	120	

Code	Wattage	Finish	Colour	CCT	Lumens
SPIKEW	1W	Stainless Steel	Daylight	6000K	75lm



Important:

Some of our outdoor lighting products may not be suitable for use in coastal areas where salt corrosion is prevalent.



OL01W



OL01P



OL01B

E27 OUTDOOR WALL LIGHT, PEDESTAL AND BOLLARD

- Opal polycarbonate 360° diffuser

Construction: Die-cast Aluminium

Driver: Not Required

Lamp type: E27 (20W max.)

ARRIVING
Q4 2020

230V
50Hz

IP54



Code	Model	Finish	Height	Width	Depth	Projection	
OL01W	Wall Light	Black	245mm	108mm	-	148mm	NEW
OL01P	Pedestal	Black	265mm	108mm	108mm	-	NEW
OL01B	Bollard	Black	650mm	108mm	108mm	-	NEW



GDL3



GDL1



GDLMK23



GDLSPIKE2



GDL2

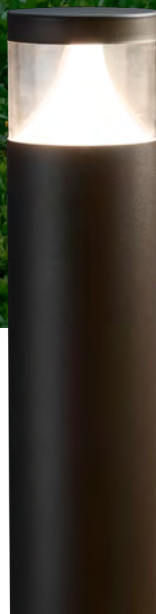

GU10 WALL LIGHT / BOLLARDS

Construction: 304 Stainless Steel
Lamp type: GU10 LED



Code	Model	Diameter	Height	Projection
GDL1	GU10 Wall Light	102mm	195mm	144mm
GDL2	GU10 Bollard	102mm	650mm	-
GDL3	GU10 Bollard	102mm	1100mm	-
GDLMK23	Mounting Kit for GDL2 and GDL3	135mm	155mm	-
GDLSPIKE2	Ground Spike for GDL2	87mm	400mm	-

Important:

Some of our outdoor lighting products may not be suitable for use in coastal areas where salt corrosion is prevalent.



OUTDOOR LIGHTING

GROUNDLIGHTS & DECK LIGHTING

Lighting that is ideal for driveways, garden walkways, patios and decking areas. These luminaries are small and discreet, but provide effective guiding illumination

Groundlights

GU10 Groundlights	272
LED Groundlights / Goundlight with Half Lip	273
LED Groundlights / LED Shallow Groundlights	274
CoB LED Groundlights	275
LED Interchangeable Wall/Groundlights	276

Deck Lighting

LED Decking Kit	276
LED Decking Lights	277
Ground Preparation Guide	278

Infrared Heaters	279
------------------	-----

Note: Some of our outdoor products may not be suitable for use in coastal areas where salt corrosion is prevalent



GU10 GROUNDLIGHT

Construction: 304 Stainless Steel

Driver: Not Required

Lamp type: GU10 LED

Bezel	Cut-out	Sleeve Ø	Recessed Depth (mm)
105	80	92	150

Code	Model
WGULEN	Round



WGULED



WSGULED



WHGULED



GU10 GROUNDLIGHT

Construction: 304 Stainless Steel

Driver: Not Required

Lamp type: GU10 LED

Cut-out	Sleeve Ø	Recessed Depth (mm)
80	92	132

Code	Model	Bezel
WGULED	Round	105mm
WSGULED	Square	100mm x 100mm
WHGULED	Hexagon	115mm x 100mm

316 STAINLESS STEEL GU10 GROUNDLIGHT

Construction: 316 Stainless Steel

Driver: Not Required

Lamp type: GU10 LED

Bezel	Cut-out	Sleeve Ø	Recessed Depth (mm)
101	80	95	190

Code	Model
316WALK	316 Stainless Steel





LED GROUNDLIGHTS

- Ideal for driveways and decking, safe for indoor and outdoor use
- Supplied with 2 metre outdoor flexible cable

Construction: 304 Stainless Steel

Driver: Integral

Lamp type: LED



Bezel Ø	Cut-out Ø	Sleeve Ø	Recessed Depth (mm)
92	61	78	94

Code	Wattage	Model	Colour	CCT	Lumens
LEDGL3W	3W	Stainless Steel	Warm White	3000K	270lm
LEDGL3D	3W	Stainless Steel	Daylight	6000K	290lm

GROUNDLIGHT WITH HALF LIP

Construction: 304 Stainless Steel

Driver: Not Required

Lamp type: GU10 LED



Bezel Ø	Cut-out Ø	Sleeve Ø	Recessed Depth	Overall Height	(mm)
88	65	70	109	138	

Code	Model
CAPWGU	Stainless Steel



LED GROUNDLIGHTS

- Pre-wired with 1.5m cable

Construction: Stainless Steel & Aluminium

Driver: integral

Lamp type: LED

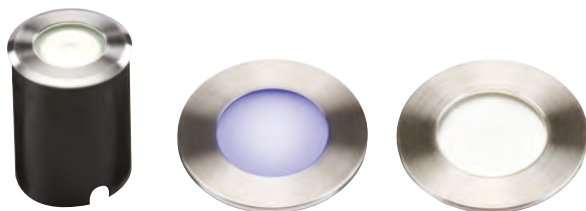

Bezel Ø	Cut-out Ø	Sleeve Ø	Recessed Depth	(mm)	
62	50	60	82.5		
Code	Wattage	Finish	Colour	CCT	Lumens
LEDM07B	1.5W	Stainless Steel	Blue	-	-
LEDM07W	1.5W	Stainless Steel	Cool White	4000K	70lm



LED SHALLOW GROUNDLIGHTS

- Pre-wired with 2.5m cable
- Supplied with polycarbonate housing
- This fitting is extremely shallow making it very versatile

Construction: Stainless Steel & Aluminium

Driver: Integral

Lamp type: LED



Bezel Ø	Cut-out Ø	Sleeve Ø	Recessed Depth	(mm)	
110	90	97	52		
Code	Wattage	Finish	Colour	CCT	Lumens
LEDM08B1	1.7W	Stainless Steel	Blue	-	-
LEDM08W1	1.7W	Stainless Steel	Cool White	4000K	90lm





COB LED GROUNDLIGHTS

- Pre-wired with 2m cable

Construction: 304 Stainless Steel

Driver: Integral

Lamp type: CoB LED

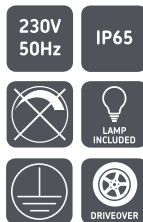

Code	Wattage	Finish	Colour	CCT	Bezel Ø	Sleeve Ø	Recessed Depth	Lumens
LDGL5	5W	Stainless Steel	Warm White	3000K	68mm	60mm	80mm	240lm
LDGL6	6W	Stainless Steel	Warm White	3000K	129mm	114mm	70mm	405lm
LDGL9	9W	Stainless Steel	Warm White	3000K	160mm	144mm	88mm	610lm



LED INTERCHANGEABLE WALL MARKER / GROUNDLIGHTS

- Supplied with 3 interchangeable chrome effect polycarbonate heads for directional light output
- Suitable for ground and wall installation
- Pre-wired with 2m cable

Construction: Stainless Steel & Polycarbonate

Driver: Integral

Lamp type: LED

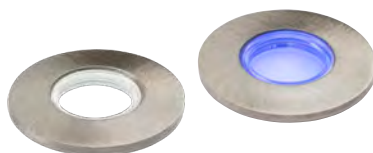

Bezel Ø	Cut-out Ø	Recessed Depth		(mm)
38	32	48		

Code	Wattage	Finish	Colour	CCT	Lumens
LEDM06B	0.6W	Brushed Nickel	Blue	-	-
LEDM06W	0.6W	Brushed Nickel	Daylight	6000K	50lm

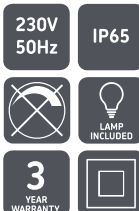

LED DECKING KIT

- 10 x 0.2W LED
- Stainless steel bezels supplied as standard

Construction: Polycarbonate

Driver: Included

Lamp type: LED

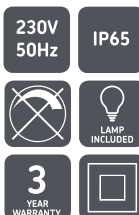

Bezel Ø	Cut-out Ø	Recessed Depth		(mm)
30	25	27		

Code	Wattage	Finish	Colour	CCT	Lumens
KIT16WW	2.2W	Stainless Steel	Warm White	3000K	105lm NEW
KIT16W	2.2W	Stainless Steel	Daylight	6000K	90lm
KIT16B	2.2W	Stainless Steel	Blue	-	-



LED DECKING LIGHTS (1W)

- Weight load: 500kg

Construction: 304 Stainless Steel

Driver: Integral

Lamp type: LED

Bezel Ø	Cut-out Ø	Sleeve Ø	Recessed Depth (mm)
62	40	60	90

Code	Wattage	Finish	Colour
HPLED1W	1W	Stainless Steel	Daylight

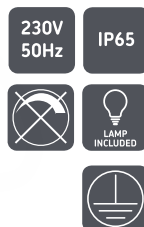

CONSTANT CURRENT LED DECKING LIGHTS

- 350mA constant current driver required

Construction: 304 Stainless Steel

Driver: Required - see page 376

Lamp type: LED

Bezel Ø	Cut-out Ø	Recessed Depth (mm)
60	50	40

Code	Wattage	Finish	Colour
1IPB	1W	Stainless Steel	Blue
1IPW	1W	Stainless Steel	Daylight



LED DECKING LIGHTS (0.5W)

- 24V constant voltage

Construction: 304 Stainless Steel

Driver: Required

Lamp type: LED

Bezel Ø	Cut-out Ø	Recessed Depth (mm)
36	28	59

Code	Wattage	Finish	Colour
4IPB	0.5W	Stainless Steel	Blue
4IPW	0.5W	Stainless Steel	Cool White



RECOMMENDED GROUND PREPARATION (IP65)

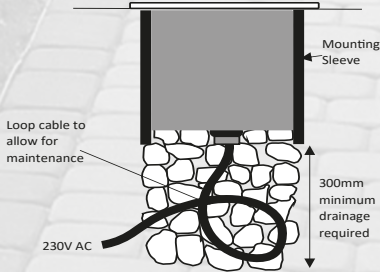

Ensure there is a minimum 300mm 'hole' below the fitting, fill with loose gravel or pea shingle

Test hole by filling with water which should drain away within 30 minutes

Leave cable loop in gravel to allow access and extraction of fitting

Final circuit connection

Use IP68 connection boxes which are gel filled if buried

Joint should be accessible for repair or maintenance

All outdoor circuits should be protected by either an RCD or RCBO

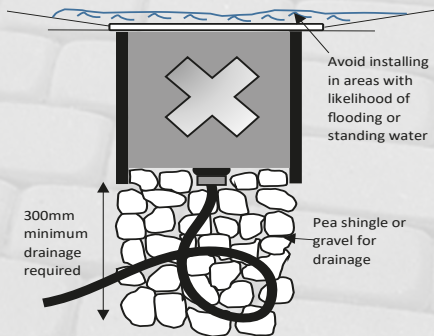
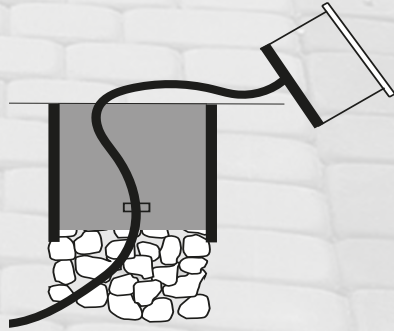

For areas with a low water table or likely to flood leaving 'standing water', IP65 fittings should be avoided.

Fittings with IP67 or IP68 ratings should be used in these installations



Pole not included

INFRARED HEATERS

- Pre-wired with 3m cable
- Wall and pole bracket supplied

Construction: Die-cast aluminium

Driver: Not required

Lamp type: R7s

Height	Length	Depth	(mm)
245	345	179	

Code	Wattage	Model
HEOD1309BK	1300W	Black
HEOD1309W	1300W	White
HEOT1300W	1300W	254mm 1300W R7s Double Ended Lamp





OUTDOOR LIGHTING FLOODLIGHTS

Floodlights provide an ultra-high lumen solution to any outdoor space. This range includes RGB and security spotlight models

Lightweight LED Floodlights	282
LED Floodlights	283
High Power LED Floodlights	284
RGB LED Floodlights	285
LED Security Spotlights	286
Twin spot security floodlights	287
HQI and SON Floodlights	288

Note: Some of our outdoor products may not be suitable for use in coastal areas where salt corrosion is prevalent



LIGHTWEIGHT LED FLOODLIGHTS

- This new range of LED floodlights offers the user quality and versatility, with the ability to add either PIR or Microwave Sensors
- High lumen - produces in excess of 105lm per watt
- Easy-install - with angled brackets and built-in connector, meaning no outdoor connections and faster installations

Construction: Die-cast Aluminium

Lamp type: LED



Angled bracket for easy installation



Easy install built-in connector



Low profile design

Code	Wattage	Colour	CCT	Height	Width	Projection	Lumens	
FLN10	10W	Cool White	4000K	70mm	95mm	29mm	1050lm	NEW
FLN20	20W	Cool White	4000K	95mm	135mm	29mm	2100lm	NEW
FLN30	30W	Cool White	4000K	110mm	160mm	29mm	3150lm	NEW
FLN50	50W	Cool White	4000K	145mm	200mm	29mm	5250lm	NEW

FLN FLOODLIGHT ACCESSORIES

Code	Model	
FLNPIR	PIR Accessory	NEW
FLNMC	Microwave Accessory	NEW

**ARRIVING
Q4 2020**



LED FLOODLIGHTS

Exclusive to Knightsbridge, this range of floodlights is manufactured from die-cast aluminium with anti-glare fascia. Ideal for domestic and commercial installations

- Instant ignition and high lumen output with driver-on-board SMD LED technology
- Installation is via easy-fix angled mounting bracket
- Internal junction box enables the installer to wire directly to the fixture without the need for external connections and boxes
- PIR sensor versions also available with override function, adjustable time, sensitivity, and lux levels

Construction: Die-cast aluminium

Lamp type: LED

PIR field of detection: 120°



Angled bracket for easy installation



Lux, time and range adjustment on PIR models, with manual override function



Internal junction box for direct wiring

230V
50Hz

IP65



Code	Wattage	Model	Colour	CCT	Height	Width	Projection	Lumens
FLR10	10W	Standard	Cool White	4000K	105mm	130mm	53mm	800lm
FLR20	20W	Standard	Cool White	4000K	125mm	150mm	53mm	1600lm
FLR30	30W	Standard	Cool White	4000K	160mm	185mm	63mm	2400lm
FLR50	50W	Standard	Cool White	4000K	205mm	225mm	63mm	4000lm
FLR10P	10W	With PIR	Cool White	4000K	140mm	130mm	53mm	800lm
FLR20P	20W	With PIR	Cool White	4000K	155mm	150mm	53mm	1600lm
FLR30P	30W	With PIR	Cool White	4000K	190mm	185mm	63mm	2400lm
FLR50P	50W	With PIR	Cool White	4000K	230mm	225mm	63mm	4000lm



UP TO
18400
LUMENS



HIGH POWER LED FLOODLIGHTS

LED Floodlights with high lumen output and instant ignition makes this luminaire ideal for security / high level illumination in commercial, retail, and industrial environments

- Internal terminal block on the rear allows for direct wiring
- Energy efficient low maintenance with high output
- Fortified bracket and fastenings



Internal terminal block for direct wiring

Construction: Die-cast aluminium

Driver: Integral

Lamp type: LED

230V
50Hz

IP65



Code	Wattage	Colour	CCT	Height	Width	Projection	Lumens	
FLP100	100W	Cool White	4000K	205mm	300mm	60mm	8400lm	
FLP100A	100W	Daylight	6000K	205mm	300mm	60mm	9200lm	NEW
FLP150	150W	Cool White	4000K	237mm	360mm	73mm	13500lm	
FLP150A	150W	Daylight	6000K	237mm	360mm	73mm	14100lm	NEW
FLP200	200W	Cool White	4000K	237mm	360mm	73mm	17150lm	
FLP200A	200W	Daylight	6000K	237mm	360mm	73mm	18400lm	NEW



RGB LED FLOODLIGHTS

- Colour changing LED floodlights
- RGB controller included

Construction: Die-cast aluminium

Driver: Integral

Lamp type: LED

230V
50Hz

IP65



3
YEAR
WARRANTY



Code	Wattage	Finish	Colour	Height	Width	Projection
FLF10RGB	10W	Black	RGB	90mm	130mm	30mm
FLF20RGB	20W	Black	RGB	126mm	180mm	30mm
FLF30RGB	30W	Black	RGB	147mm	210mm	37mm
FLF50RGB	50W	Black	RGB	182mm	260mm	41mm



LED SECURITY SPOTLIGHTS WITH PIR

- Adjustable die-cast aluminium head and polycarbonate body
- Cree LED
- Instant ignition
- Easy-fix mounting for simple installation
- Integral 180° PIR sensor with adjustable lux and time settings - 10m detection range (approx.)

Construction: Die-cast aluminium & polycarbonate

Driver: Integral

Lamp type: CoB LED

PIR field of detection: 180°

230V
50Hz

IP44



Code	Wattage	Finish	CCT	Height	Width	Projection	Lumens
FL8BK	8W	Black	5000K	176mm	78mm	107mm	610lm
FL8W	8W	White	5000K	176mm	78mm	107mm	610lm
FL16BK	2 x 8W	Black	5000K	176mm	141mm	113mm	1100lm
FL16W	2 x 8W	White	5000K	176mm	141mm	113mm	1100lm



TWIN SPOT SECURITY FLOODLIGHTS

- 2 x 9W LED
- Individual adjustable heads
- Long life and low-maintenance
- Ideal for outdoor and indoor applications; domestic, retail, and commercial use

PIR version:

- Illuminates for a fixed period of 90 seconds - illumination is constant whilst movement is detected
- Manual override facility
- Maximum detection distance approx. 8 metres

Construction: Die-cast aluminium

Driver: Integral

Lamp type: LED

PIR field of detection: 120°

230V
50Hz

IP65



Code	Model	Wattage	CCT	Height	Width	Projection	Lumens
FLTB	Black	2 x 9W	3500K	104mm	165mm	150mm	1300lm
FLTW	White	2 x 9W	3500K	104mm	165mm	150mm	1300lm
FLTPB	Black with PIR	2 x 9W	3500K	120mm	165mm	150mm	1300lm
FLTPW	White with PIR	2 x 9W	3500K	120mm	165mm	150mm	1300lm



HQI ALUMINIUM FLOODLIGHT

- Die-cast aluminium body, complete with integral control gear and ignitor
- Asymmetrical reflector
- Bracket for wall mounting

Construction: Die-cast aluminium
Lamp type: RX7



Height	Width	Projection	Depth	(mm)
350	231	257	85	

Code	Model
TR150HQI	150W SON/HQI

SON FLOODLIGHTS

- Symmetrical reflector
- Internal photocell sensor, thermal photodiode dusk to dawn function. On - min. 20 lux | Off - max. 80 lux.
- Bracket for wall mounting

Construction: Polycarbonate
Lamp type: E27 70W SON-I

Height	Width	Projection	Depth	(mm)
300	275	280	208	

Code	Model
TRHP70	70W SON
TRHP70PC	70W SON with Sensor





Knightsbridge

Committed to a brighter future



At Knightsbridge, we believe in looking after our customers and looking after our planet. This philosophy is important to us and is why we have started to apply it to the way we package and present our products.

We are now working in conjunction with the FSC® moving towards 100% recyclable / 100% recycled packaging solutions. Look out for the FSC® label on our certified packaging.



This is our plan, this is our commitment to a brighter future.



ENVIRONMENTALLY APPROPRIATE forest management ensures that the harvest of timber and non-timber products maintains the forest's biodiversity, productivity, and ecological processes.



SOCIALLY BENEFICIAL forest management helps both local people and society at large to enjoy long term benefits and also provides strong incentives to local people to sustain the forest resources and adhere to long-term management plans.



ECONOMICALLY VIABLE forest management means that forest operations are structured and managed so as to be sufficiently profitable, without generating financial profit at the expense of the forest resource, the ecosystem, or affected communities.



COMMERCIAL LIGHTING BULKHEADS & WALL PACKS

These luminaries provide a high lumen output, long life and low running costs. Bulkheads can be wall or ceiling mounted, making them an efficient and versatile lighting option

Polo Bulkheads	292
Round Bulkheads	293
Square Bulkheads / BPLED Gear Trays	294
LED Bulkheads	295
CCT Adjustable LED Bulkheads & Accessories	296-298
Polo LED Bulkheads / Round LED Bulkheads	300
LED Halo Bulkheads	301
IK10 CCT Adjustable LED Bulkheads	302-303
E27 and B22 Amenity Bulkheads	304
LED Amenity Wall Packs / E27 Dome Bulkheads	305
CCT Adjustable Wall Pack	306



- Robust luminaire for internal or external use that can be wall or ceiling mounted
- Manufactured from tough polycarbonate with HF soft start electronic control gear in all models
- Choose from opal or prismatic diffusers
- Twist & lock mechanism allows for easy lamp change and maintenance
- All polo bulkheads are supplied complete with 2D 3500K lamp
- Supplied as standard with white bezel



16W POLO BULKHEADS

Construction: Polycarbonate

Lamp type: 2D 16W

Overall Ø	Projection	(mm)
270	95	

Code	Wattage	Model	Colour	CCT
TPB16WPHF	16W	Prismatic Diffuser	White	3500K
TPB16WOHF	16W	Opal Diffuser	White	3500K

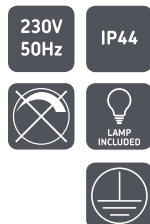

TPB16 TRIMS



Code	Finish
TPB16BRRG	Brass
TPB16CHRG	Chrome

28W POLO BULKHEADS

Overall Ø	Projection	(mm)
330	110	

Construction: Polycarbonate

Lamp type: 2D 28W

Code	Wattage	Model	Colour	CCT
TPB28WPHF	28W	Prismatic Diffuser - Standard	White	3500K
TPB28WPEMHF	28W	Prismatic Diffuser - Emergency	White	3500K
TPB28WOHF	28W	Opal Diffuser - Standard	White	3500K
TPB28WOEMHF	28W	Opal Diffuser - Emergency	White	3500K

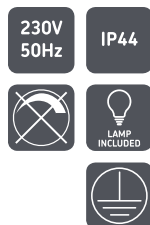

TPB33 TRIMS



Code	Finish
TPB33BRRG	Brass
TPB33CHRG	Chrome

16W ROUND BULKHEADS

Construction: Polycarbonate

Lamp type: 2D 16W



Overall Ø	Projection	(mm)
200	80	



Code	Wattage	Model	Colour	CCT
TPR16WPHF	16W	Prismatic Diffuser	White	3500K
TPR16W0HF	16W	Opal Diffuser	White	3500K

28W ROUND BULKHEADS

Construction: Polycarbonate

Lamp type: 2D 28W



Overall Ø	Projection	(mm)
285	80	



Code	Wattage	Model	Finish	Colour	CCT
TPR28WPHF	28W	Prismatic Diffuser	White Trim	White	3500K
TPR28BPHF	28W	Prismatic Diffuser	Black Trim	White	3500K
TPR28WPEMHF	28W	Prismatic Diffuser - Emergency	White Trim	White	3500K
TPR28W0HF	28W	Opal Diffuser	White Trim	White	3500K
TPR28W0EMHF	28W	Opal Diffuser - Emergency	White Trim	White	3500K



28W SQUARE BULKHEADS

Construction: Polycarbonate

Lamp type: 2D 28W



Length	Width	Projection	(mm)
285	285	80	



Code	Wattage	Model	Finish	Colour	CCT
TPS28WPHF	28W	Prismatic Diffuser	White Trim	White	3500K
TPS28WPEMHF	28W	Prismatic Diffuser - Emergency	White Trim	White	3500K
TPS28BPHF	28W	Prismatic Diffuser	Black Trim	White	3500K
TPS28BPEMHF	28W	Prismatic Diffuser - Emergency	Black Trim	White	3500K
TPS28WOHF	28W	Opal Diffuser	White Trim	White	3500K
TPS28WOEMHF	28W	Opal Diffuser - Emergency	White Trim	White	3500K
TPS28BOHF	28W	Opal Diffuser	Black Trim	White	3500K
TPS28BOEMHF	28W	Opal Diffuser - Emergency	Black Trim	White	3500K

BPLED LED GEAR TRAYS

- Ideal replacement for traditional circular 2D 28W bulkheads
- Available with emergency function
- High SMD LED output and energy efficient

Construction: Cem-1

Driver: Included

Lamp type: SMD LED

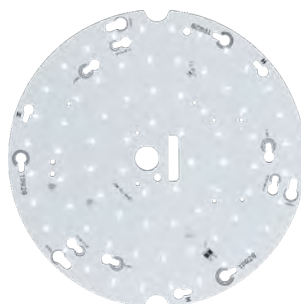

Overall Ø	(mm)
246	

Code	Wattage	Model	Colour	CCT	Lumens
BPLED	14W	Standard	Cool White	4000K	1400lm
BPLEDEM	14W	Emergency	Cool White	4000K	1400lm



- Constructed from robust polycarbonate, ideal for commercial and domestic use
- Complete with hinged gear tray for easy installation
- Available in standard, microwave sensor, and emergency options

12W/20W LED BULKHEADS

Construction: Polycarbonate

Lamp type: LED

Overall Ø	Projection	(mm)
305	84 (12W)	
400	96 (20W)	



Code	Wattage	Model	Colour	CCT	Lumens
BL12LED	12W	Standard	Cool White	4000K	1000lm
BL20LED	20W	Standard	Cool White	4000K	1600lm
BL12LEDE	12W	Emergency	Cool White	4000K	1000lm
BL20LEDE	20W	Emergency	Cool White	4000K	1600lm
BL12LEDS	12W	Sensor	Cool White	4000K	1000lm
BL20LEDS	20W	Sensor	Cool White	4000K	1600lm



CCT ADJUSTABLE LED BULKHEAD

This versatile IP65 LED bulkhead boasts LED colour changing technology enabling the installer / end-user to adjust the colour temperature via a switch on the gear tray.

- Time saving and user-friendly installation via hinged gear tray and push fit terminal block
- Specialised polycarbonate diffuser ensures high lumen levels with smooth uninterrupted light
- Suitable for domestic and commercial applications, wall or ceiling mounted
- A range of easy-fit coloured trims and eyelid options make this an extremely adaptable and time-saving solution
- Trim and eyelid options are manufactured from polycarbonate and easy to fix via simple push-fit design
- Supplied with white bezel

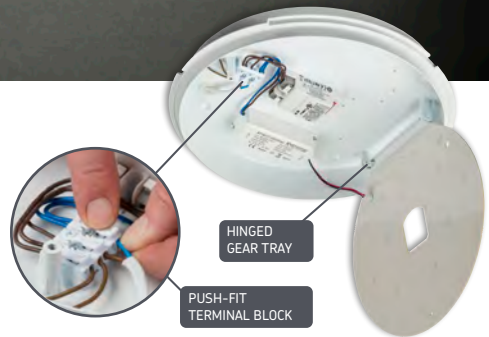

Construction: Polycarbonate

Driver: Included

Lamp type: LED

20W CCT ADJUSTABLE LED BULKHEAD



- CCT adjustable to 3000K, 1530lm / 4000K, 1760lm / 5700K, 1640lm

Overall Ø	Projection	(mm)
380	81	

Code	Wattage	Model	Colour	CCT
BT20CT	20W	Standard	CCT	3000/4000/5700K
BT20CTEM	20W	Emergency	CCT	3000/4000/5700K
BT20CTS	20W	Sensor	CCT	3000/4000/5700K
BT20CTEMS	20W	Emergency and Sensor	CCT	3000/4000/5700K
BT20CTA	20W	Sensor (Corridor Function)	CCT	3000/4000/5700K
BT20CTEMA	20W	Emergency and Sensor (Corridor Function)	CCT	3000/4000/5700K

14W CCT ADJUSTABLE LED BULKHEAD

- CCT adjustable to 3000K, 1085lm / 4000K, 1285lm / 5700K, 1130lm

Overall Ø	Projection	(mm)
315	74	

Code	Wattage	Model	Colour	CCT
BT14CT	14W	Standard	CCT	3000/4000/5700K
BT14CTEM	14W	Emergency	CCT	3000/4000/5700K
BT14CTS	14W	Sensor	CCT	3000/4000/5700K
BT14CTEMS	14W	Emergency and Sensor	CCT	3000/4000/5700K
BT14CTA	14W	Sensor (Corridor Function)	CCT	3000/4000/5700K
BT14CTEMA	14W	Emergency and Sensor (Corridor Function)	CCT	3000/4000/5700K

9W CCT ADJUSTABLE LED BULKHEAD

- CCT adjustable to 3000K, 665lm / 4000K, 760lm / 5700K, 700lm

Overall Ø	Projection	(mm)
256	74	

Code	Wattage	Model	Colour	CCT
BT9CT	9W	Standard	CCT	3000/4000/5700K
BT9CTEM	9W	Emergency	CCT	3000/4000/5700K
BT9CTS	9W	Sensor	CCT	3000/4000/5700K
BT9CTEMS	9W	Emergency and Sensor	CCT	3000/4000/5700K

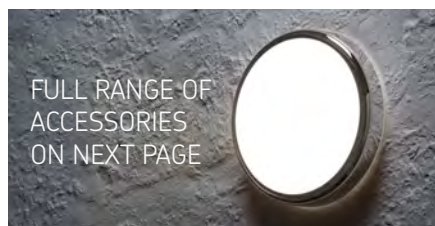



BT9 BEZELS

Code	Finish
BT9CHR	Chrome
BT9B	Black
BT9G	Grey
BT9MBR	Brass
BT9SLV	Matt Silver

BT14 BEZELS

Code	Finish
BT14CHR	Chrome
BT14B	Black
BT14G	Grey
BT14MBR	Brass
BT14SLV	Matt Silver

BT20 BEZELS

Code	Finish
BT20CHR	Chrome
BT20B	Black
BT20G	Grey
BT20MBR	Brass
BT20SLV	Matt Silver



BT9 EYELIDS

Code	Finish
BT9EB	Black
BT9EG	Grey
BT9ES	Silver

BT14 EYELIDS

Code	Finish
BT14EB	Black
BT14EG	Grey
BT14ES	Silver





HAVE A QUESTION? CHAT WITH OUR TEAM **INSTANTLY!**

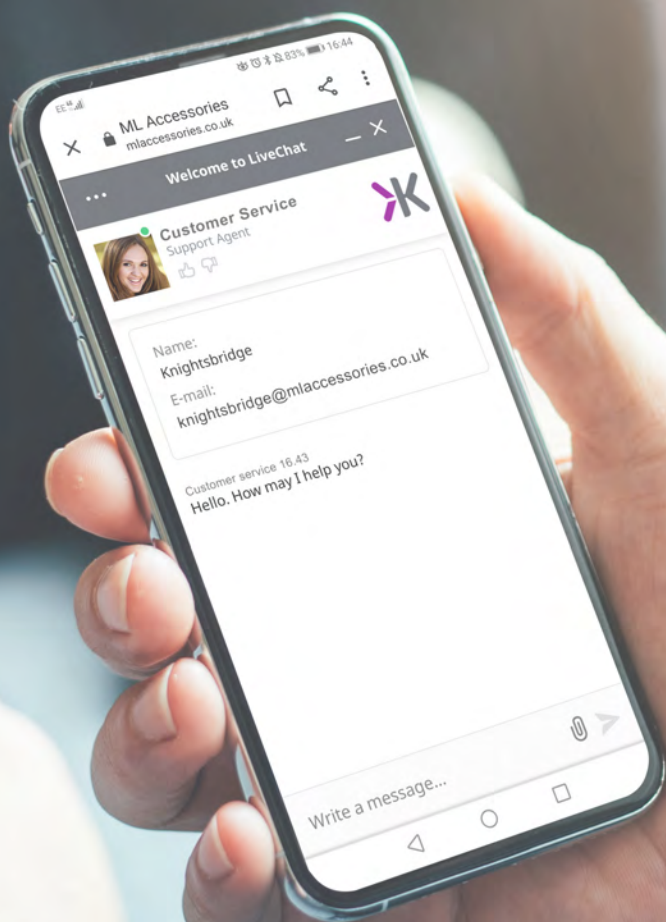

www.mlaccessories.co.uk



14W POLO LED BULKHEADS

- Features include a specially designed diffuser to ensure optimum lumen output
- Energy efficient and cool running
- Suitable for commercial and domestic applications



Construction: Polycarbonate

Lamp type: LED

Overall Ø	Projection	(mm)
330	110	



Code	Wattage	Model	Colour	CCT	Lumens
TPB14LED	14W	Standard	Daylight	6000K	1070lm
TPB14EMLED	14W	Emergency	Daylight	6000K	1070lm
TPB14SLED	14W	Sensor	Daylight	6000K	1070lm
TPB14EMSLED	14W	Emergency and Sensor	Daylight	6000K	1070lm
TPB14LEDA	14W	Sensor (Corridor Function)	Daylight	6000K	1070lm

TPB TRIMS



Code	Finish
TPB33BRRG	Brass
TPB33CHRG	Chrome

14W ROUND LED BULKHEAD

- Lightweight robust polycarbonate body
- Hinged gear tray for easy wiring and maintenance
- Comparable luminaire lumen output to 28W 2D fluorescent lamp



Construction: Polycarbonate

Lamp type: LED

Overall Ø	Projection	(mm)
285	86	



Code	Model	Wattage	Colour	CCT	Lumens
TPR14LED	Standard	14W	Cool White	4000K	1100lm
TPR14LEDA	Sensor (Corridor Function)	14W	Cool White	4000K	1100lm
TPR14LEDEM	Emergency	14W	Cool White	4000K	1100lm
TPR14LEDS	Sensor	14W	Cool White	4000K	1100lm

HALO BULKHEADS

- Low profile design with a range of bezels available to create an ambient halo backwash effect
- Supplied with 6000K LED tray as standard, alternative 4000K tray available

Construction: Polycarbonate & Acrylic

Lamp type: LED



14W LED HALO BULKHEADS

Overall Ø	Projection	(mm)
291	97	

Code	Wattage	Model	Colour	CCT	Lumens
BF1430	14W	Standard	Daylight	6000K	1020lm
BF1430EM	14W	Emergency	Daylight	6000K	1020lm
BF1430S	14W	Sensor	Daylight	6000K	1020lm
BF1430EMS	14W	Emergency and Sensor	Daylight	6000K	1020lm
BF14L4K	14W	Cool White Gear Tray	Cool White	4000K	-

24W LED HALO BULKHEADS

Overall Ø	Projection	(mm)
318	117	

Code	Wattage	Model	Colour	CCT	Lumens
BF2440	24W	Standard	Daylight	6000K	1600lm
BF2440EM	24W	Emergency	Daylight	6000K	1600lm
BF2440S	24W	Sensor	Daylight	6000K	1600lm
BF2440EMS	24W	Emergency and Sensor	Daylight	6000K	1600lm
BF24L4K	24W	Cool White Gear Tray	Cool White	4000K	-

BF14 TRIMS



Code	Finish
BF14BBR	Matt Brass
BF14BCHR	Chrome
BF14BMS	Matt Silver
BF14BWHT	White

BF24 TRIMS



Code	Finish
BF24BBR	Matt Brass
BF24BCHR	Chrome
BF24BMS	Matt Silver
BF24BWHT	White



A robust range of die-cast LED bulkheads. Features included are anti-vandal fixings CCT LED and high IK rating. Ideal for a wide range of environments

- CCT adjustable
- Low energy, low maintenance
- Standard and eyelid designs available



ANTI-VANDAL
DIFFUSER AND FIXINGS

18W CCT ADJUSTABLE LED BULKHEAD

Construction: Die-cast Aluminium
Lamp type: LED

IK10

230V
50Hz

IP65



5
YEAR
WARRANTY

Overall Ø	Projection	(mm)
360	92	

Code	Wattage	Model	Finish	CCT	Lumens
SHE1B	18W	Standard	Black	3000/4000/6000K	1680/1790/1810lm
SHE1BEM	18W	Emergency	Black	3000/4000/6000K	1680/1790/1810lm
SHE1BEMP	18W	Emergency + Daylight Sensor	Black	3000/4000/6000K	1680/1790/1810lm
SHE1BEMS	18W	Emergency + Microwave Sensor	Black	3000/4000/6000K	1680/1790/1810lm
SHE1BP	18W	Daylight Sensor	Black	3000/4000/6000K	1680/1790/1810lm
SHE1BS	18W	Microwave Sensor	Black	3000/4000/6000K	1680/1790/1810lm
SHE1G	18W	Standard	Grey	3000/4000/6000K	1680/1790/1810lm
SHE1GEM	18W	Emergency	Grey	3000/4000/6000K	1680/1790/1810lm
SHE1GEMP	18W	Emergency + Daylight Sensor	Grey	3000/4000/6000K	1680/1790/1810lm
SHE1GEMS	18W	Emergency + Microwave Sensor	Grey	3000/4000/6000K	1680/1790/1810lm
SHE1GP	18W	Daylight Sensor	Grey	3000/4000/6000K	1680/1790/1810lm
SHE1GS	18W	Microwave Sensor	Grey	3000/4000/6000K	1680/1790/1810lm



18W CCT ADJUSTABLE LED EYELID BULKHEAD

Construction: Die-cast Aluminium
Lamp type: LED

Overall Ø	Projection	(mm)
360	94	

IK10

ANTI-VANDAL
DIFFUSER AND FIXINGS

**230V
50Hz**

IP65



Code	Wattage	Model	Finish	CCT	Lumens
SHE2B	18W	Standard	Black	3000/4000/6000K	1020/1080/1090lm
SHE2BEM	18W	Emergency	Black	3000/4000/6000K	1020/1080/1090lm
SHE2BEMP	18W	Emergency + Daylight Sensor	Black	3000/4000/6000K	1020/1080/1090lm
SHE2BEMS	18W	Emergency + Microwave Sensor	Black	3000/4000/6000K	1020/1080/1090lm
SHE2BP	18W	Daylight Sensor	Black	3000/4000/6000K	1020/1080/1090lm
SHE2BS	18W	Microwave Sensor	Black	3000/4000/6000K	1020/1080/1090lm
SHE2G	18W	Standard	Grey	3000/4000/6000K	1020/1080/1090lm
SHE2GEM	18W	Emergency	Grey	3000/4000/6000K	1020/1080/1090lm
SHE2GEMP	18W	Emergency + Daylight Sensor	Grey	3000/4000/6000K	1020/1080/1090lm
SHE2GEMS	18W	Emergency + Microwave Sensor	Grey	3000/4000/6000K	1020/1080/1090lm
SHE2GP	18W	Daylight Sensor	Grey	3000/4000/6000K	1020/1080/1090lm
SHE2GS	18W	Microwave Sensor	Grey	3000/4000/6000K	1020/1080/1090lm



E27 AMENITY BULKHEADS

Construction: Aluminium & Polycarbonate

Lamp type: E27 (100W max.)

Width	Length	Projection	(mm)
105	240	110	

Code	Model
E27PC	Prismatic Diffuser
E27PR	Red Diffuser



B22 AMENITY BULKHEADS

Construction: Aluminium & Polycarbonate

Lamp type: B22d (BH22BC - 100W max. / BH22PB - 60W max.)

Width	Length	Projection	(mm)
124	244	120	

Code	Model
BH22BC	Aluminium Trim (Class I)
BH22PB	Black Polycarbonate Trim (Class II)





LED AMENITY WALLPACKS

Construction: Polycarbonate

Driver: Integral

Lamp type: LED



Width	Length	Projection (mm)
108	197	78



Code	Wattage	Model	Colour	CCT	Lumens
AMLEDB	5W	White / Black Base	Cool White	4000K	440lm
AMLEDBS	5W	White / Black Base with Sensor	Cool White	4000K	410lm
AMLEDR	5W	Red / Black Base	Red	-	-
AMLEDW	5W	White / White Base	Cool White	4000K	460lm
AMLEDWS	5W	White / White Base with Sensor	Cool White	4000K	410lm

E27 DOME BULKHEADS

Construction: Aluminium & Glass

Lamp type: E27 (60W max.)

Height	Width	Projection (mm)
210	100	110

Code	Model
TPOV60B	Black
TPOV60W	White





15W CCT ADJUSTABLE WALL PACK WITH SENSOR

Construction: Die-cast Aluminium

Driver: Integral

Lamp type: LED

Height	Width	Projection (mm)
218	147	78

230V 50Hz	IP65			5 YEAR WARRANTY	
--------------	------	--	--	-----------------------	--

Code	Wattage	Model	Colour	CCT	Lumens
WP15CTP	15W	Daylight Sensor	CCT Adjustable	3000/4000/5000K	1790/1835/1955lm NEW

SERVICE



ALL CALLS ANSWERED
IN 3 RINGS OR LESS



SAME DAY COLLECTION
FROM OUR WAREHOUSE



QUOTES WITHIN
1 HOUR



DELIVER DIRECT TO
YOUR CUSTOMERS
WITH K-DIRECT



5PM CUT OFF NEXT DAY
DELIVERY (MON-THU)
(3PM ON FRIDAYS)



ORDER TRACKING
AVAILABLE





COMMERCIAL LIGHTING

COMMERCIAL DOWNLIGHTS

These discreet, modern downlights are perfect for office, retail and other commercial spaces. This range includes the extremely versatile CPL LED Panel Downlights

Recess/Surface CCT Adjustable LED Panel Downlights

310-311

LED Downlights

312-313

LED Wallwashers

313



RECESS / SURFACE CCT ADJUSTABLE LED PANEL DOWNLIGHTS

This innovative dual mounting LED Panel is the ideal replacement for recessed traditional CFL / fluorescent downlights. Available in four sizes, the adjustable recessed fixings enable replacement for existing recessed light fixtures, and is easily adaptable for existing apertures of between 55mm - 250mm (subject to model). This ensures minimal redecoration and fast installation.

- Available in four sizes
- Pre-wired with 300mm cable
- Adjustable recessed brackets, suitable for 55mm to 250mm cut-out
- Edge-lit
- Optional magnetic bezels available

Construction: Polycarbonate

Driver: Integral

Lamp type: LED

RECESS
MOUNTED

SURFACE
MOUNTED

ADJUSTABLE
MOUNTING BRACKET

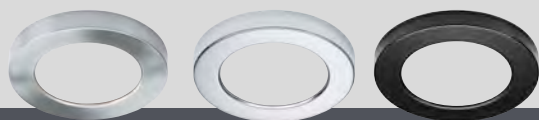

EASY-FIT MAGNETIC BEZELS



Supplied with white bezel as standard

230V
50Hz

IP20



3
YEAR
WARRANTY





6W LED PANEL DOWNLIGHT

- CCT adjustable to 3000K, 400lm / 4000K, 430lm / 6000K, 410lm

Overall Ø	Min. Void	Min./Max. Cut-out (mm)
140	50	Min. 55 - Max. 100

Code	Wattage
CPL6CT	6W
CPL6BC	Brushed Chrome Bezel
CPL6PC	Polished Chrome Bezel
CPL6MB	Matt Black Bezel NEW



12W LED PANEL DOWNLIGHT

- CCT adjustable to 3000K, 850lm / 4000K, 940lm / 6000K, 920lm

Overall Ø	Min. Void	Min./Max. Cut-out (mm)
165	50	Min. 55 - Max. 125

Code	Wattage
CPL12CT	12W
CPL12BC	Brushed Chrome Bezel
CPL12PC	Polished Chrome Bezel
CPL12MB	Matt Black Bezel NEW



18W LED PANEL DOWNLIGHT

- CCT adjustable to 3000K, 1300lm / 4000K, 1400lm / 6000K, 1360lm

Overall Ø	Min. Void	Min./Max. Cut-out (mm)
217	50	Min. 55 - Max. 175

Code	Wattage
CPL18CT	18W
CPL18BC	Brushed Chrome Bezel
CPL18PC	Polished Chrome Bezel
CPL18MB	Matt Black Bezel NEW

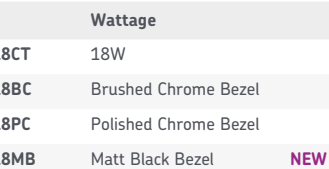

24W LED PANEL DOWNLIGHT

- CCT adjustable to 3000K, 1940lm / 4000K, 2140lm / 6000K, 2100lm

Overall Ø	Min. Void	Min./Max. Cut-out (mm)
290	50	Min. 55 - Max. 250

Code	Wattage
CPL24CT	24W
CPL24BC	Brushed Chrome Bezel
CPL24PC	Polished Chrome Bezel
CPL24MB	Matt Black Bezel NEW





LED CCT ADJUSTABLE DOWNLIGHT

Construction: Polycarbonate

Driver: Integral

Lamp type: LED

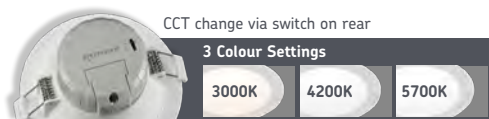

CCT change via switch on rear

3 Colour Settings

3000K

4200K

5700K

230V
50Hz

IP44



3
YEAR
WARRANTY



Cut-out Ø	Overall Ø	Minimum Void	Recessed Depth	(mm)
92	110	113	63	
Code	Wattage	CCT	Lumens	
RDL9CCT	9W	3000/4200/5700K	800/880/850lm	

LED ROUND RECESSED ADJUSTABLE DOWNLIGHTS

- Low power consumption when compared to classic CDM light source
- Reliable constant colour rendering and light output
- Low-maintenance and energy efficient providing cost savings
- Ideal for retail, office, and commercial applications

Construction: Aluminium

Driver: Included

Lamp type: LED

Tilt: 40°

Rotation: 350°



230V
50Hz

IP40



3
YEAR
WARRANTY



Cut-out Ø	Overall Ø	Minimum Void	Recessed Depth	(mm)
134	157	150	98 (15W)	
160	190	172	122 (40W)	
Code	Wattage	Colour	CCT	Lumens
WW15C	15W	Cool White	4000K	1400lm
WW40C	40W	Cool White	4000K	3650lm

CoB LED RECESSED DOWNLIGHTS

- Recessed dimmable LED fixtures with high lumen output
- Supplied with dimmable driver (please check dimmer compatibility)
- Ideal for commercial and retail environments

Construction: Aluminium & Polycarbonate

Driver: Included

Lamp type: CoB LED



Emergency Kit code:
EMKIT2 (see page 359
for details)

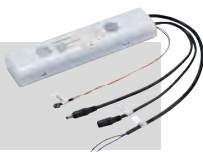

Minimum Void	Recessed Depth	(mm)
100	70	



Code	Wattage	Colour	CCT	Lumens	Overall Ø	Cut-out Ø
CRDL10	10W	Cool White	4000K	1080lm	135mm	125mm
CRDL15	15W	Cool White	4000K	1780lm	195mm	175mm
CRDL20	20W	Cool White	4000K	2430lm	195mm	175mm
CRDL30	30W	Cool White	4000K	3480lm	230mm	200mm

LED RECTANGULAR RECESSED WALLWASHERS

- Low power consumption when compared to classic CDM light source
- Reliable constant colour rendering and light output
- Low-maintenance and energy efficient providing cost savings
- Supplied complete with remote driver
- Ideal for retail, office, and commercial applications



Construction: Aluminium

Driver: Included

Lamp type: LED

Tilt: 60°



Length	Width	Minimum Void	Recessed Depth	Cut-out Dimensions	(mm)
240	157	135	85	222 x 125	

Code	Wattage	Colour	CCT	Lumens
WW30R	30W	Cool White	4000K	2800lm
WW40R	40W	Cool White	4000K	3650lm



COMMERCIAL LIGHTING

RECESSED, SURFACE, & SUSPENSION LIGHTING

Modular panels, surface mounted and suspension. Options, ideal for offices, retail, and a wide array of other commercial facilities

LED Recessed Modular Fittings	316
LED Panel	317
T8 Recessed Modular Fittings	318
PL and T8 Recessed Fluorescent Fittings	319
T5 Modular Fluorescent Fittings / T8 Surface Mounted Luminaire	320
LED Surface Mounted Luminaire	321



LED RECESSED MODULAR FITTINGS

- An energy-efficient alternative to standard 4x18W fluorescent modular fittings
- Long-life, low maintenance
- Compatible with standard 600mm x 600mm 15mm and 25mm grids
- Instant ignition, ideal for external sensors

Construction: Steel

Driver: Included

Lamp type: LED

Width	Length	Recessed Depth	(mm)
595	595	52	

230V 50Hz	IP20			5 YEAR WARRANTY	
--------------	------	--	--	-----------------------	--

Code	Wattage	Colour	CCT	Lumens
MRBLED	32W	Cool White	4000K	3370lm
MRBLED6	32W	Daylight	6000K	3450lm

EMKIT2
Emergency Kit
See page 359





LED PANEL

- Compatible with standard 600mm x 600mm 15mm and 25mm grids
- White trim
- Diffuser TP(a) rated

Construction: Aluminium / Polycarbonate

Driver: Included

Lamp type: LED

Width	Length	Recessed Depth	(mm)
595	595	9.8	

230V
50Hz

IP20



3
YEAR
WARRANTY



Code	Wattage	Colour	CCT	Lumens
LEDPAN38	38W	Cool White	4000K	4330lm



EMKIT2
Emergency Kit
See page 359



T8 RECESSED MODULAR FITTINGS (4 x 18W)

Construction: Steel

Lamp type: Fluorescent



Width	Length	Recessed Depth	(mm)
595	595	80	



Code	Wattage	Model
MRB418HF	72W	4 x 18W - Standard
MRB418EMHF	72W	4 x 18W - Emergency

FR600	Fire Hood (600mm x 600mm)
-------	---------------------------



T8 RECESSED MODULAR FITTINGS (4 x 36W)

Construction: Steel

Lamp type: Fluorescent



Width	Length	Recessed Depth	(mm)
595	1195	86	



Code	Wattage	Model
MRA436HF	144W	4 x 36W - Standard
MRA436EMHF	144W	4 x 36W - Emergency

FR1200	Firehood (600mm x 1200mm)
--------	---------------------------



PL RECESSED MODULAR FLUORESCENT FITTINGS

- Requires 2 x 55W 4-Pin PL lamps (not supplied with fitting)
- 1 x high frequency electronic ballast supplied
- Both designs are suitable for indirect lighting, the model with double parabolic louvre is also suitable for direct lighting

Construction: Steel

Lamp type: Fluorescent



MRE255PLHF

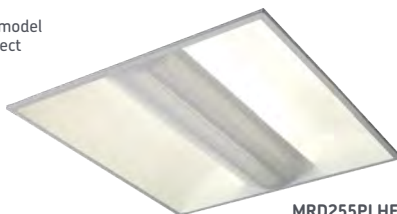

MRD255PLHF

Width	Length	Recessed Depth	(mm)
595	595	120	



Code	Model
MRD255PLHF	2 x 55W PL
MRE255PLHF	2 x 55W PL (with Double Parabolic Louvre)
MRE255PLEMHF	2 x 55W PL (with Double Parabolic Louvre) - Emergency

T8 MODULAR FLUORESCENT FITTINGS (4 x 18W)

Construction: Steel

Lamp type: Fluorescent

Width	Length	Projection	(mm)
600	610	80	



Code	Model
SURF418HF	4 x 18W T8
SURF418EMHF	4 x 18W T8 - Emergency





T5 MODULAR FLUORESCENT FITTINGS (4 x 14W)

Construction: Steel
Lamp type: Fluorescent

Width	Length	Projection	(mm)
596	596	52	

Code	Model
SURF414HF	4 x 14W T5
SURF414EMHF	4 x 14W T5 - Emergency



T8 SURFACE MOUNTED LUMINAIRE

Construction: Steel
Lamp type: Fluorescent

Projection	(mm)
80	



Code	Model	Width	Length
SURF236HF	2 x 36W T8	304mm	1220mm
SURF236EMHF	2 x 36W T8 - Emergency	304mm	1220mm
SURF258HF	2 x 58W T8	304mm	1520mm
SURF258EMHF	2 x 58W T8 - Emergency	304mm	1520mm
SURF270HF	2 x 70W T8	300mm	1785mm
SURF270EMHF	2 x 70W T8 - Emergency	300mm	1785mm

SUSPENSION KIT

Code	Model
5FTT5KIT	2m Suspension Kit



LED SURFACE MOUNTED LUMINAIRE

- Surface mounted high lumen LED luminaire
- Ideal for educational and nursing / care facilities, commercial, and retail environments

Construction: Polycarbonate

Driver: Included

Lamp type: LED

Width	Projection	(mm)
198	68	



Code	Wattage	Model	Length	Colour	CCT	Lumens
PRCLED	49W	Standard	1490mm	Cool White	4000K	6110lm
PRCLEDEM	49W	Emergency	1490mm	Cool White	4000K	6110lm
PRCLED4	43W	Standard	1229mm	Cool White	4000K	4700lm
PRCLEDEM4	43W	Emergency	1229mm	Cool White	4000K	4700lm



COMMERCIAL LIGHTING BATTENS

Our huge range of battens provides a suitable product for any application. This includes innovative LED battens designed for quick and easy installations

T8 Fluorescent Battens / T8 Prismatic Diffusers / T8 Reflectors	324
T5 Fluorescent Battens / T5 Prismatic Diffusers	325
T8 LED Tubes / T8 LED Battens	326
High Output LED Battens	328-329
LED Battens	330-331
LED CCT Adjustable Battens	332
LED Single & Twin Battens	333



T8 HF SINGLE FLUORESCENT BATTENS

- Supplied complete with high frequency control gear

Construction: Steel

Lamp type: Fluorescent



Width	Projection	(mm)
61	82	

Code	Model	Length	Qty
T8118HF	1 x 18W	617mm	4
T8136HF	1 x 36W	1227mm	4
T8136EMHF	1 x 36W - Emergency	1227mm	1
T8158HF	1 x 58W	1527mm	4
T8158EMHF	1 x 58W - Emergency	1527mm	1
T8170HF	1 x 70W	1791mm	4
T8170EMHF	1 x 70W - Emergency	1791mm	1



T8 PRISMATIC DIFFUSERS

Construction: Polycarbonate

Code	Model	Length	Qty
T8DIFF136	1 x 36W	4ft	2
T8DIFF158	1 x 58W	5ft	2
T8DIFF170	1 x 70W	6ft	2
T8DIFF236	2 x 36W	4ft	2
T8DIFF258	2 x 58W	5ft	2
T8DIFF270	2 x 70W	6ft	2



T8 HF TWIN FLUORESCENT BATTENS

Construction: Steel

Lamp type: Fluorescent



Width	Projection	(mm)
101	86	

Code	Model	Length	Qty
T8218HF	2 x 18W	617mm	4
T8236HF	2 x 36W	1227mm	4
T8236EMHF	2 x 36W - Emergency	1227mm	1
T8258HF	2 x 58W	1527mm	4
T8258EMHF	2 x 58W - Emergency	1527mm	1
T8270HF	2 x 70W	1791mm	4
T8270EMHF	2 x 70W - Emergency	1791mm	1



T8 REFLECTORS

Construction: Steel

Width	Projection	(mm)
150	45	

Code	Model	Length	Qty
T8REF36	Reflector for 36W	4ft	4
T8REF58	Reflector for 58W	5ft	4
T8REF70	Reflector for 70W	6ft	4

T5 HF SINGLE FLUORESCENT BATTENS

Construction: Steel

Lamp type: Fluorescent

Width	Projection	(mm)
63	82.5	

Code	Wattage	Model	Length	Qty
T5114	14W	1 x 14W	575mm	4
T5128	28W	1 x 28W	1175mm	4
T5128EM	28W	1 x 28W - Emergency	1175mm	1
T5135	35W	1 x 35W	1475mm	4
T5135EM	35W	1 x 35W - Emergency	1475mm	1
T5149	49W	1 x 49W	1475mm	4
T5149EM	49W	1 x 49W - Emergency	1475mm	1



T5 HF TWIN FLUORESCENT BATTENS

Construction: Steel

Lamp type: Fluorescent

Width	Projection	(mm)
63	83.5	

Code	Wattage	Model	Length	Qty
T5214	14W	2 x 14W	575mm	4
T5228	28W	2 x 28W	1175mm	4
T5228EM	28W	2 x 28W - Emergency	1175mm	1
T5235	35W	2 x 35W	1475mm	4
T5235EM	35W	2 x 35W - Emergency	1475mm	1
T5249	49W	2 x 49W	1475mm	4
T5249EM	49W	2 x 49W - Emergency	1475mm	1



T5 PRISMATIC DIFFUSERS

- Streamlined, anti-glare, polycarbonate prismatic diffuser
- Complete with end caps
- Diffuser fits single and twin fitting

Construction: Polycarbonate

Code	Model	Qty
T5DIF2	2ft	2
T5DIF4	4ft	2
T5DIF5	5ft	2





T8 LED TUBES

- Energy efficient, long life, cost effective alternative to classic T8 fluorescent lamps
- Manufactured from shatterproof, robust polycarbonate
- Instant ignition provides uniform illumination
- Integral driver and mercury-free components ensure safe environment
- Ideally for use with Knightsbridge dedicated LED battens, however, these can be used with most prewired dedicated LED battens
- Not for use with external electronic or magnetic ballasts

Construction: Aluminium & Polycarbonate

Driver: Integral

Lamp type: LED

230V
50Hz

IP20



Code	Wattage	Model	Length	Colour	CCT	Lumens
T8LED2	10W	2ft	604mm	Cool White	4000K	1100lm
T8LED2D	10W	2ft	604mm	Daylight	6000K	1100lm
T8LED4	20W	4ft	1214mm	Cool White	4000K	2350lm
T8LED4D	20W	4ft	1214mm	Daylight	6000K	2400lm
T8LED5	24W	5ft	1514mm	Cool White	4000K	2750lm
T8LED5D	24W	5ft	1514mm	Daylight	6000K	2900lm
T8LED6	30W	6ft	1778mm	Cool White	4000K	3350lm
T8LED6D	30W	6ft	1778mm	Daylight	6000K	3400lm



05020 Batten Sensor, page 365

T8 LED BATTENS

- Supplied pre-wired for use with dedicated T8 LED self-ballasted tubes
- Supplied without a ballast (necessary for use with fluorescent lights)
- For use with LED tubes which are powered from one side only
- Manufactured in sizes to replace most standard traditional T8 fluorescent fixtures
- Tubes not included

Construction: Steel

Lamp type: LED

230V
50Hz

IP20



Code	Model	Width	Length	Projection	Qty
T8LB14	Single (4ft)	63mm	1225mm	80mm	4
T8LB15	Single (5ft)	63mm	1525mm	80mm	4
T8LB16	Single (6ft)	63mm	1778mm	80mm	4
T8LB24	Twin (4ft)	102mm	1225mm	86mm	4
T8LB25	Twin (5ft)	102mm	1525mm	86mm	4
T8LB26	Twin (6ft)	102mm	1778mm	86mm	4





We're only a click away.

K-Direct is a quick and reliable home delivery service that provides next day delivery (across mainland UK) with a no-minimum order value or quantity. Simply place your customer's order online and have it delivered direct on your behalf. Cut out the time spent double handling and order exactly what you want without having to order minimum product quantities. Don't let logistics stand in the way of you and our fantastic products - order with K-Direct and ensure a professional, fast and efficient delivery service.

Our responsive website ensures, however you access our products, your experience is quick and hassle free.

**Quality products,
first class delivery**

-
- A quick and reliable home delivery service
 - Shipping direct to your customers on **YOUR** behalf
 - In excess of 3000 product lines in stock now
 - Quality which is not compromised, MLA is renowned for a 1st class customer service experience
 - No minimum box quantities*
 - No minimum order value
 - Reduces commitment to stock
 - No double handling
 - Next day delivery across mainland UK
 - Fast, efficient and professional
 - Created for our wholesalers to satisfy their customers

* Exceptions apply to fragile items

Place your customers order online and have it delivered direct on your behalf



HIGH OUTPUT LED BATTENS

- Dedicated non-replaceable LED light source
- Traditional T8 powder-coated steel body
- Purposely designed around the traditional T8 body to suit refurbishment projects with the appearance of a T8 batten
- Polycarbonate diffuser ensures strength and security resulting in minimal possibility of damage
- Virtually maintenance-free.
- Ideal for replacement or as an alternative for T5/T8
- Perfect for indoor use in commercial, retail and domestic environments
- Compatible with external microwave and sensor controls

LED SINGLE BATTENS

Construction: Stainless Steel

Driver: Integral

Lamp type: LED



05020 Batten Sensor, page 365

Width	Projection	(mm)
60	85	

230V
50Hz

IP20

LAMP
INCLUDED

5
YEAR
WARRANTY

Code	Wattage	Model	Length	Colour	CCT	Lumens
T8BLED12	10W	(2ft) - Standard	615mm	Cool White	4000K	1200lm
T8BLED14	20W	(4ft) - Standard	1225mm	Cool White	4000K	2300lm
T8BLED15	26W	(5ft) - Standard	1525mm	Cool White	4000K	3000lm
T8BLED15EM1	26W	(5ft) - Emergency	1525mm	Cool White	4000K	3000lm NEW
T8BLED16	30W	(6ft) - Standard	1790mm	Cool White	4000K	3450lm
T8BLED16EM1	30W	(6ft) - Emergency	1790mm	Cool White	4000K	3450lm NEW



LED TWIN BATTENS

Construction: Stainless Steel

Driver: Integral

Lamp type: LED

Width	Projection	(mm)
95	85	



Code	Wattage	Model	Length	Colour	CCT	Lumens
T8BLED22	20W	(2ft) - Standard	615mm	Cool White	4000K	2200lm
T8BLED24	40W	(4ft) - Standard	1225mm	Cool White	4000K	4500lm
T8BLED25	50W	(5ft) - Standard	1525mm	Cool White	4000K	5250lm
T8BLED25EM1	50W	(5ft) - Emergency	1525mm	Cool White	4000K	5250lm NEW
T8BLED25HL	80W	(5ft) - High Lumen	1525mm	Cool White	4000K	9100lm
T8BLED25HLEM	80W	(5ft) - High Lumen + Emergency	1525mm	Cool White	4000K	9100lm
T8BLED26	60W	(6ft) - Standard	1790mm	Cool White	4000K	6500lm
T8BLED26EM1	60W	(6ft) - Emergency	1790mm	Cool White	4000K	6500lm NEW
T8BLED26HL	100W	(6ft) - High Lumen	1790mm	Cool White	4000K	10700lm
T8BLED26HLEM	100W	(6ft) - High Lumen + Emergency	1790mm	Cool White	4000K	10700lm



LED BATTENS

- High efficiency - up to 120lm/W
- Rear and end conduit fixings
- Hinged gear tray and push-fit loop in/loop out connectors, for quick and easy installation
- Ideal replacement for most traditional fluorescent battens, including high lumen models that substitute traditional twin fittings

Construction: Pressed Steel

Driver: Included

Lamp type: LED

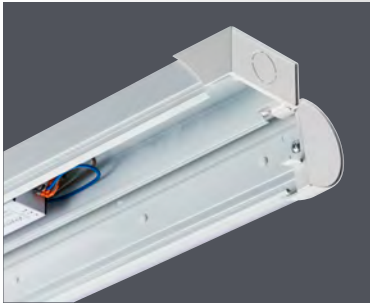

Width	Projection	(mm)
61	71	



Code	Wattage	Model	Length	Colour	CCT	Lumens	
BATS2	12W	Standard	615mm	Cool White	4000K	1315lm	NEW
BATS4	22W	Standard	1225mm	Cool White	4000K	2625lm	NEW
BATS4EM	22W	Emergency	1225mm	Cool White	4000K	2625lm	NEW
BATS4S	22W	Sensor	1225mm	Cool White	4000K	2625lm	NEW
BATS5	37W	Standard	1525mm	Cool White	4000K	4290lm	NEW
BATS5EM	37W	Emergency	1525mm	Cool White	4000K	4290lm	NEW
BATS5S	37W	Sensor	1525mm	Cool White	4000K	4290lm	NEW
BATS5EMS	37W	Sensor + Emergency	1525mm	Cool White	4000K	4290lm	NEW



05020 Batten Sensor, page 365

Code	Wattage	Model	Length	Colour	CCT	Lumens	
BATS5H	55W	High Lumen	1525mm	Cool White	4000K	5925lm	NEW
BATS5EMH	55W	High Lumen + Emergency	1525mm	Cool White	4000K	5925lm	NEW
BATS6	42W	Standard	1790mm	Cool White	4000K	4875lm	NEW
BATS6EM	42W	Emergency	1790mm	Cool White	4000K	4875lm	NEW
BATS6S	42W	Sensor	1790mm	Cool White	4000K	4875lm	NEW
BATS6EMS	42W	Sensor + Emergency	1790mm	Cool White	4000K	4875lm	NEW
BATS6H	60W	High Lumen	1790mm	Cool White	4000K	6475lm	NEW
BATS6EMH	60W	High Lumen + Emergency	1790mm	Cool White	4000K	6475lm	NEW



LED CCT ADJUSTABLE BATTENS

These LED Battens offer ultra high efficiency, with the latest CCT changing and LED Chip technology on-board, and convenience.

- Push-fit terminals with innovative hinged LED tray for ease of installation
- Options available include microwave sensor, emergency, and high lumen output
- Ideal replacement for old fluorescent fittings with retrofit fixing points

Construction: Steel & Polycarbonate

Driver: Included

Lamp type: LED



05020 Batten Sensor, page 365

Width	Projection	(mm)
61	71	

230V 50Hz	IP20			5 YEAR WARRANTY	
--------------	------	--	--	-----------------------	--

Code	Wattage	Model	Length	CCT	Lumens
BATC4	22W	Standard	1170mm	3000/4000/6000K	2545/2765/2745lm
BATC4EM	22W	Emergency	1170mm	3000/4000/6000K	2545/2765/2745lm
BATC5	35W	Standard	1470mm	3000/4000/6000K	3775/4160/4160lm
BATC5S	35W	Sensor	1470mm	3000/4000/6000K	3775/4160/4160lm NEW
BATC5EM	35W	Emergency	1470mm	3000/4000/6000K	3775/4160/4160lm
BATC5H	60W	High Lumen	1470mm	3000/4000/6000K	6670/7440/7035lm
BATC5EMH	60W	High Lumen + Emergency	1470mm	3000/4000/6000K	6670/7440/7035lm
BATC6	40W	Standard	1734mm	3000/4000/6000K	4645/5045/4955lm
BATC6S	40W	Sensor	1734mm	3000/4000/6000K	4645/5045/4955lm NEW
BATC6EM	40W	Emergency	1734mm	3000/4000/6000K	4645/5045/4955lm
BATC6H	67W	High Lumen	1734mm	3000/4000/6000K	7255/8100/7715lm
BATC6EMH	67W	High Lumen + Emergency	1734mm	3000/4000/6000K	7255/8100/7715lm



LED SINGLE BATTENS

- Double-insulated, lightweight, versatile, slimline design
- Simple installation via an easy-wire terminal box on the rear
- Alternative option to T5/T8 batten
- Ideal for commercial, retail, and domestic use in hallways, kitchens, and under cabinets

Construction: Aluminium & Polycarbonate

Lamp type: LED

Width	Projection	(mm)
30	45	



Code	Wattage	Length	Colour	CCT	Lumens
LEDBAT9	9W	605mm	Cool White	4000K	900lm
LEDBAT17	17W	1220mm	Cool White	4000K	1800lm
LEDBAT22	22W	1520mm	Cool White	4000K	2400lm
LEDBAT26	25W	1768mm	Cool White	4000K	2700lm



LED TWIN BATTENS

Construction: Aluminium & Polycarbonate

Lamp type: LED

Width	Projection	(mm)
60	52	



Code	Wattage	Length	Colour	CCT	Lumens
LEDBATW35	35W	1200mm	Cool White	4000K	3700lm
LEDBATW44	44W	1500mm	Cool White	4000K	4700lm
LEDBATW44EM	44W	1500mm	Cool White	4000K	4700lm
LEDBATW50	50W	1768mm	Cool White	4000K	5350lm
LEDBATW50EM	50W	1768mm	Cool White	4000K	5350lm





COMMERCIAL LIGHTING NON-CORROSIVE

Durable, non-corrosive battens perfect for industrial applications

T5 Non-Corrosive Fluorescent Fittings	336
230V & 110V T8 Non-Corrosive Fluorescent Fittings	337
LED-Ready Non-Corrosive Fittings	339
Integral LED Non-Corrosive Fittings	340-341
Slimline LED Non-Corrosive Fittings	342
High Bay / Low Bay	344-345

NON-CORROSIVE IP65 T5 AND T8 FLUORESCENT FITTINGS:

- Manufactured from strong robust polycarbonate
- High output polycarbonate prismatic lens for optimum light output
- Min./max. operating temperatures: -15°C / +30°C
- Polycarbonate clips, fixing brackets and 20mm compression gland included
- Can be surface mounted or suspended with suspension eye
- Push-fit terminals for ease of installation



OS020 Batten Sensor, page 365

T5 HF SINGLE NON-CORROSIVE FLUORESCENT FITTINGS

Construction: Polycarbonate

Lamp type: T5

Width	Projection	(mm)
65	75	

Code	Model	Length
NC65128HF	1 x 28W (4ft) - Standard	1210mm
NC65135HF	1 x 35W (5ft) - Standard	1510mm
NC65135EMHF	1 x 35W (5ft) - Emergency	1510mm



T5 HF TWIN NON-CORROSIVE FLUORESCENT FITTINGS

Construction: Polycarbonate

Lamp type: T5

Width	Projection	(mm)
104	75	

Code	Model	Length
NC65228HF	2 x 28W (4ft) - Standard	1210mm
NC65235HF	2 x 35W (5ft) - Standard	1510mm
NC65235EMHF	2 x 35W (5ft) - Emergency	1510mm



STAINLESS STEEL CLIPS

- Optional stainless steel clips for T5 non-corrosive fittings

Code	Model	Qty
NCT5CLIP	Stainless Steel Clip	20





T8 HF SINGLE NON-CORROSIVE FLUORESCENT FITTINGS

Construction: Polycarbonate

Lamp type: T8

Width	Projection	(mm)
94	90	

Code	Model	Length
AC65118	1 x 18W (2ft) - Standard	653mm
AC65136	1 x 36W (4ft) - Standard	1263mm
AC65136EM	1 x 36W (4ft) - Emergency	1263mm
AC65158	1 x 58W (5ft) - Standard	1563mm
AC65158EM	1 x 58W (5ft) - Emergency	1563mm
AC65170	1 x 70W (6ft) - Standard	1828mm
AC65170EM	1 x 70W (6ft) - Emergency	1828mm



T8 HF TWIN NON-CORROSIVE FLUORESCENT FITTINGS

Construction: Polycarbonate

Lamp type: T8

Width	Projection	(mm)
129	90	

Code	Model	Length
AC65218	2 x 18W (2ft) - Standard	653mm
AC65236	2 x 36W (4ft) - Standard	1263mm
AC65236EM	2 x 36W (4ft) - Emergency	1263mm
AC65258	2 x 58W (5ft) - Standard	1563mm
AC65258EM	2 x 58W (5ft) - Emergency	1563mm
AC65270	2 x 70W (6ft) - Standard	1828mm
AC65270EM	2 x 70W (6ft) - Emergency	1828mm



110V T8 HF NON-CORROSIVE FLUORESCENT FITTINGS

Construction: Polycarbonate

Lamp type: T8



Model	Width	Projection	(mm)
Single	94	90	
Twin	129	90	

Code	Model	Length
AC651581	1 x 58W (5ft) - Standard	1563mm
AC651581EM	1 x 58W (5ft) - Emergency	1563mm
AC652581	2 x 58W (5ft) - Standard	1563mm
AC652581EM	2 x 58W (5ft) - Emergency	1563mm



STAINLESS STEEL CLIPS

- Optional stainless steel clips for T8 non-corrosive fittings

Code	Model	Qty
ACCLIP	Stainless Steel Clip	20



KEEP UP TO DATE WITH NEW PRODUCTS, SPECIAL OFFERS, AND MORE



Knightsbridge

 @KnightsbridgeML

 @Knightsbridgemia

 @Knightsbridge

 @Knightsbridgemia



LED-READY SINGLE NON-CORROSIVE FITTINGS

- Constructed from impact-resistant durable polycarbonate base and diffuser
- Supplied pre-wired for use with dedicated T8 LED self-ballasted tubes (LED tube not included)
- Ideal for industrial and commercial applications

Construction: Polycarbonate

Driver: Not Required

Lamp type: T8 LED

Width	Projection	(mm)
94	90	

Code	Model	Length
NCLB12	Single (2ft)	653mm
NCLB14	Single (4ft)	1263mm
NCLB15	Single (5ft)	1563mm
NCLB16	Single (6ft)	1828mm



OS020 Batten Sensor, page 365

LED-READY TWIN NON-CORROSIVE FITTINGS

Construction: Polycarbonate

Driver: Not Required

Lamp type: T8 LED

Width	Projection	(mm)
129	90	

Code	Model	Length
NCLB22	Twin (2ft)	653mm
NCLB24	Twin (4ft)	1263mm
NCLB25	Twin (5ft)	1563mm
NCLB26	Twin (6ft)	1828mm





INTEGRAL LED NON-CORROSIVE FITTINGS

INCLUDES 110V MODELS FOR SITE LIGHTING

- High output IP65 LED non-corrosive fittings
- Constructed from impact-resistant durable polycarbonate base and diffuser
- Fitting supplied with quick-fit connector and complete with fixing accessories
- Ideal replacement for standard fluorescent fixtures
- Optional stainless steel accessories available



INTEGRAL LED SINGLE NON-CORROSIVE FITTINGS

Construction: Polycarbonate

Driver: Integral

Lamp type: LED



05020 Batten Sensor, page 365

Width	Projection	(mm)
94	90	



Code	Wattage	Model	Length	Colour	CCT	Lumens
TRLED12	14W	Single (2ft) - Standard	653mm	Cool White	4000K	1530lm
TRLED14	23W	Single (4ft) - Standard	1263mm	Cool White	4000K	2650lm
TRLED14EM	23W	Single (4ft) - Emergency	1263mm	Cool White	4000K	2650lm
TRLED15	29W	Single (5ft) - Standard	1563mm	Cool White	4000K	3650lm
TRLED151	29W	Single (5ft) - 110V	1563mm	Cool White	4000K	3400lm
TRLED151EM	29W	Single (5ft) - 110V Emergency	1563mm	Cool White	4000K	3400lm
TRLED15D	29W	Single (5ft) - Standard	1563mm	Daylight	6000K	3610lm
TRLED15EM	29W	Single (5ft) - Emergency	1563mm	Cool White	4000K	3650lm
TRLED15EMD	29W	Single (5ft) - Emergency	1563mm	Daylight	6000K	3610lm
TRLED16	33W	Single (6ft) - Standard	1828mm	Cool White	4000K	4100lm
TRLED16D	33W	Single (6ft) - Standard	1828mm	Daylight	6000K	3960lm
TRLED16EM	33W	Single (6ft) - Emergency	1828mm	Cool White	4000K	4100lm
TRLED16EMD	33W	Single (6ft) - Emergency	1828mm	Daylight	6000K	3960lm



INTEGRAL LED TWIN NON-CORROSIVE FITTINGS

Construction: Polycarbonate
Driver: Integral
Lamp type: LED

Width	Projection	(mm)	230V 50Hz	IP65		 LAMP INCLUDED	5 YEAR WARRANTY		110V
129	90								

Code	Wattage	Model	Length	Colour	CCT	Lumens
TRLED22	28W	Twin (2ft) - Standard	653mm	Cool White	4000K	3050lm
TRLED221	28W	Twin (2ft) - 110V	653mm	Cool White	4000K	3000lm
TRLED221EM	28W	Twin (2ft) - 110V Emergency	653mm	Cool White	4000K	3000lm
TRLED24	41W	Twin (4ft) - Standard	1263mm	Cool White	4000K	4670lm
TRLED24EM	41W	Twin (4ft) - Emergency	1263mm	Cool White	4000K	4670lm
TRLED25	50W	Twin (5ft) - Standard	1563mm	Cool White	4000K	5800lm
TRLED25D	50W	Twin (5ft) - Standard	1563mm	Daylight	6000K	5700lm
TRLED25EM	50W	Twin (5ft) - Emergency	1563mm	Cool White	4000K	5800lm
TRLED25EMD	50W	Twin (5ft) - Emergency	1563mm	Daylight	6000K	5700lm
TRLED26	69W	Twin (6ft) - Standard	1828mm	Cool White	4000K	7770lm
TRLED26D	69W	Twin (6ft) - Standard	1828mm	Daylight	6000K	7820lm
TRLED26EM	69W	Twin (6ft) - Emergency	1828mm	Cool White	4000K	7770lm
TRLED26EMD	69W	Twin (6ft) - Emergency	1828mm	Daylight	6000K	7820lm

STAINLESS STEEL CLIPS

Code	Model	Qty
ACCLIP	Stainless Steel Clip	20





SLIMLINE LED NON-CORROSIVE FITTINGS

- Slimline, low-profile, high output dedicated LED non-corrosive fittings
- Built for longevity and efficiency
- Innovative wiring system enabling installation with no need to open the product
- An ideal alternative to conventional T8/ T5

Construction: Polycarbonate
Driver: Integral
Lamp type: LED



OS020 Batten Sensor, page 365

Width	Projection	(mm)
86	66 (36W) 72 (48W / 60W)	

230V
50Hz

IP65

LAMP INCLUDED

3
YEAR WARRANTY

Code	Wattage	Model	Length	Colour	CCT	Lumens
NCLED36	36W	(4ft) - Standard	1180mm	Cool White	4000K	3000lm
NCLED36EM	36W	(4ft) - Emergency	1180mm	Cool White	4000K	3000lm
NCLED36S	36W	(4ft) - Sensor	1180mm	Cool White	4000K	3000lm
NCLED48	48W	(5ft) - Standard	1480mm	Cool White	4000K	4000lm
NCLED48EM	48W	(5ft) - Emergency	1480mm	Cool White	4000K	4000lm
NCLED48S	48W	(5ft) - Sensor	1480mm	Cool White	4000K	4000lm
NCLED60	60W	(5ft) - Standard	1480mm	Cool White	4000K	5700lm
NCLED60S	60W	(5ft) - Sensor	1480mm	Cool White	4000K	5700lm



HAVE A QUESTION? CHAT WITH OUR TEAM **INSTANTLY!**

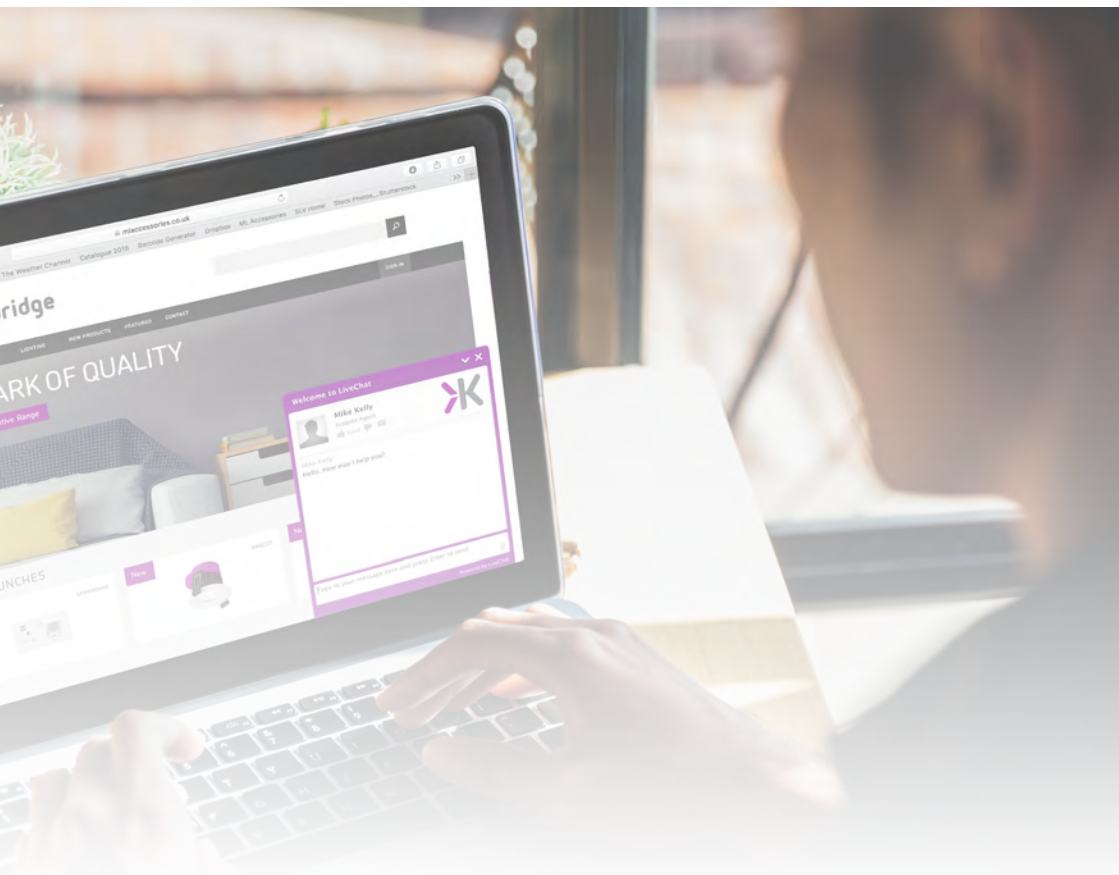

Knightsbridge

www.mlaccessories.co.uk



LED HIGH BAY

Our latest dimmable LED High Bay has an improved high LED lumen efficiency (130lm/W). Supplied with 1-10V dimmable driver (1-10V dimmer is required) and a suspension hook.

- Suspended or surface mountable
- High lumen output for indoor use

Construction: Aluminium

Driver: Integral

Lamp type: LED

Beam angle: 115°

230V
50Hz

IP65



Code	Wattage	Diameter	Projection	Colour	CCT	Lumens
HBN150	150W	298mm	193mm	Daylight	5500K	19800lm
HBN200	200W	360mm	215mm	Daylight	5500K	27000lm



MICROWAVE DIMMING SENSOR

- Supplied with fixing bracket
- Simple to fix
- 1-10V dimming only
- 360° detection angle



Overall Ø	Projection (mm)
80	62

Code	Model
HBNS1	Microwave 1 - 10V Dimming Sensor

LED HIGH BAY REFLECTOR

- Modifies HBN High Bay beam angle from 115° to 80°
- Simple installation (supplied with 4 3x12mm screws)

Projection: 153mm

Code	Model	Diameter
HBNR1	Reflector (for HBN150)	382mm
HBNR2	Reflector (for HBN200)	463mm

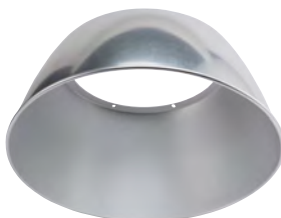

SON/HQI LOW BAY

- Powder-coated sheet steel
- Toughened glass front cover
- Symmetrical reflector

Construction: Steel

Ballast: Included

Lamp type: Metal Halide

Length	Width	Projection	(mm)
590	280	150	

Code	Model
TR250SLB	250W max.
TR400SLB	400W max.





EMERGENCY LIGHTING

A comprehensive range of emergency floodlights, bulkheads, exit signs, downlights and emergency kits. The range includes products with self-test facilities

Emergency Floodlights	348-349
Emergency Bulkheads	350-351
Exit Signs & Legends	352
Suspended / Recessed / Dual-mounting Exit Signs	353-355
Emergency Downlights	356-358
Emergency Kits	359



LED EMERGENCY FLOODLIGHT

- Robust lightweight polycarbonate case and spotlights
- High lumen output
- Suitable for non-maintained use only
- **EMTWINST ONLY**: self test facility in accordance with EN 62034

Construction: Polycarbonate

Lamp type: LED



AUTO
SELF-TEST

Height	Projection	Width	(mm)
301	90	280	

230V 50Hz	IP65			3 YEAR WARRANTY	
--------------	------	--	--	-----------------------	--

Code	Wattage	Model	Colour	CCT	Emergency Lumens	
EMTWINIP	2 x 3W	3-hour	Daylight	6000K	490lm	
EMTWINST	2 x 3W	Self-test - 3-hour	Daylight	6000K	490lm	NEW



LED EMERGENCY FLOODLIGHT

- Constructed from durable lightweight polycarbonate
- Replacement for traditional twin halogen units
- Long life, high lumen, low-maintenance
- Suitable for non-maintained use only

Construction: Polycarbonate

Lamp type: LED

Height	Projection	Width	(mm)
270	70	273	



Code	Wattage	Model	Colour	CCT	Emergency Lumens
EMTWINPC	2 x 3W	3-hour	Daylight	6500K	410lm

LED EMERGENCY FLOODLIGHT

- Replacement for traditional twin halogen units
- Long life, high lumens, low-maintenance
- Suitable for non-maintained use only

Construction: Polycarbonate

Lamp type: LED



Height	Projection	Width	(mm)
260	130	293	



Code	Wattage	Model	Colour	CCT	Emergency Lumens
EMTWIN	2 x 3W	3-hour	Warm White	3000K	375lm

3W LED EMERGENCY BULKHEAD

- Hinged gear tray and push-fit connector for simple installation
- Complete with self-adhesive legend kit
- Suitable for maintained or non-maintained use

Construction: Polycarbonate

Lamp type: LED



Height	Projection	Length	(mm)
117	60	350	



Code	Wattage	Model	Colour	CCT	Lumens	Emergency Lumens
EMLED4	3W	3-hour	Daylight	5500K	115lm	115lm

6W LED EMERGENCY BULKHEAD

- Hinged gear tray for ease of installation
- Legend kit included
- Suitable for maintained or non-maintained use

Construction: Polycarbonate

Lamp type: LED



Height	Projection	Length	(mm)
107	76	345	



Code	Wattage	Model	Colour	CCT	Lumens	Emergency Lumens
EMLED1	6W	3-hour	Daylight	6500K	405lm	120lm

4W LED EMERGENCY BULKHEAD

- Hinged gear tray for ease of installation
- Legend kit included
- Suitable for maintained or non-maintained use

Construction: Polycarbonate

Lamp type: LED

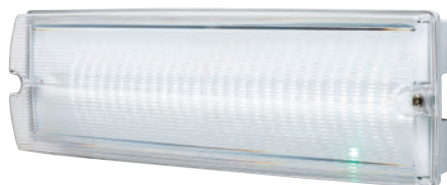

Height	Projection	Length	(mm)
110	60	351	



Code	Wattage	Model	Colour	CCT	Lumens	Emergency Lumens
EMLED3	4W	3-hour	Daylight	6500K	160lm	100lm

3W COMPACT LED EMERGENCY BULKHEAD

- 40% smaller than the standard emergency luminaire
- Hinged gear tray for ease of installation
- Legend kit, opal and prismatic diffuser included
- Suitable for maintained or non-maintained use



Construction: Polycarbonate

Lamp type: LED

Height	Projection	Length	(mm)
97	48	216	



Code	Wattage	Model	Colour	CCT	Lumens	Emergency Lumens
EMLED2A	3W	3-hour	Daylight	6000K	150lm	115lm

4W LED EMERGENCY SELF-TEST BULKHEAD

- Self-test facility in accordance with EN 62034, ensuring periodic testing at pre-programmed intervals
- Suitable for maintained or non-maintained use
- Low maintenance



Construction: Polycarbonate

Lamp type: LED

Height	Projection	Length	(mm)
110	60	350	



Code	Wattage	Model	Colour	CCT	Lumens	Emergency Lumens
EMLED5	4W	Self-test - 3-hour	Daylight	6000K	150lm	135lm

**SELF-ADHESIVE LEGEND
KIT SUPPLIED WITH ALL
EMERGENCY BULKHEADS**



WALL MOUNTED LED EXIT SIGN AND LEGENDS

- Lightweight wall mounted metal frame with polycarbonate legends
- Supplied as standard with arrow up - alternative legends available
- Suitable for maintained or non-maintained use

Construction: Pressed Steel

Lamp type: LED



Height	Projection	Width	(mm)
190	60	390	



Code	Wattage	Model	Colour	CCT	Lumens	Emergency Lumens
EMRUN	6W	3-hour	Daylight	6000K	105lm	50lm

LEGENDS

- To fit EMEXIT, EMXST, EMLSUS and EMLREC

Code	Model
EMRUND	Down Legend
EMRUNL	Left Legend
EMRUNR	Right Legend
EMRUNU	Up Legend

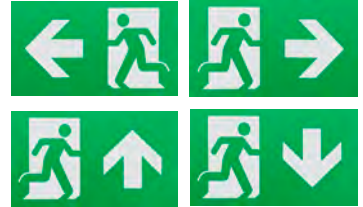

WALL MOUNTED SELF-TEST EXIT SIGN AND LEGENDS

- Self-test facility in accordance with EN 62034
- Lightweight, durable polycarbonate with interchangeable legends
- Supplied with arrow up, alternative down and left/right legends included
- Suitable for maintained or non-maintained use

Construction: Polycarbonate

Lamp type: LED



Height	Projection	Width	(mm)
169	42	324	



Code	Wattage	Model	Colour	CCT	Lumens	Emergency Lumens
EMRNST	4W	Self-test - 3-hour	Daylight	6000K	150lm	120lm

NEW

SELF-TEST

**AUTO
SELF-TEST**

WHAT IS SELF-TEST?

The self-test feature is built into each product and conducts routine functional and duration testing in accordance with the relevant standards, obviating the need for costly manual testing and intervention other than to record and rectify faults.

WHAT ARE THE BENEFITS?

Self-test lighting offers convenience, compliance, cost savings, and ease of fault identification. With no requirement to isolate the mains supply to test, there is no disruption to the normal working day and no loss of productivity.

HOW DOES IT WORK?

After installation and an initial 24-hour charging period, the product conducts its own self-test operation. This comprises of a 3-hour duration test, after which a 30-second 'monthly' function test is carried out every 28 days, and then yearly another 3-hour duration test. Following each self-test sequence, the unit will revert into charging mode.

The unit's status and any fault modes are shown by the bi-colour LED indicator and manual initiation of the testing procedure is also possible should it be required.

SUSPENDED LED EXIT SIGN (4W) AND LEGENDS

- Supplied as standard with arrow up - alternative legends available
- Suitable for maintained or non-maintained use
- Comes with 1.5m suspension kit terminating in aluminium ceiling plate

Construction: Polycarbonate

Lamp type: LED



Height	Length	Width	(mm)
222	332	25	



Code	Wattage	Model	Colour	CCT	Lumens	Emergency Lumens
EMSWING	4W	3-hour	Daylight	6000K	70lm	34lm

Code	Model
EMSWINGD	Down Legend

Code	Model
EMSWINGLR	Left/Right Legend



DUAL MOUNTING LED EXIT SIGN

- Lightweight, wall or ceiling mounted
- Supplied as standard with arrow up - alternative legends available
- Suitable for maintained or non-maintained use (not switched maintained)
- **EMXST ONLY:** Self-test facility in accordance to EN 62034

Construction: Aluminium

Lamp type: LED



CEILING
MOUNTED

WALL
MOUNTED

Height	Length	Projection	(mm)
230	310	44	

230V
50Hz

IP20



3
YEAR
WARRANTY



AUTO
SELF-TEST

Code	Wattage	Model	Colour	CCT	Lumens	Emergency Lumens
EMEXIT	4W	3-hour	Daylight	6000K	92lm	90lm
EMXST	4W	Self-test - 3-hour	Daylight	6000K	40lm	10.5lm

SUSPENDED LED EXIT SIGN

- Lightweight suspendable ceiling mounted LED exit sign
- Polycarbonate legends, supplied as standard with arrow up – alternative legends available
- For maintained or non-maintained use (not switched maintained)



Construction: Polycarbonate

Lamp type: LED

Height	Length	Width	(mm)
185	300	45	



Code	Wattage	Model	Colour	CCT	Lumens	Emergency Lumens
EMLSUS	2W	3-hour	Cool White	6000K	15lm	8lm



RECESSED LED EXIT SIGN

- Polycarbonate legends, supplied as standard with arrow up – alternative legends available
- For maintained or non-maintained use (not switched maintained)

Construction: Polycarbonate

Lamp type: LED

Projection	Length	Width	(mm)
170	335	76	



Code	Wattage	Model	Colour	CCT	Lumens	Emergency Lumens
EMLREC	2W	3-hour	Cool White	6000K	15lm	8lm

LEGENDS

Code	Model
EMEXITL2	Up Legend
EMEXITL3	Down Legend
EMEXITLR	Left/Right Legend



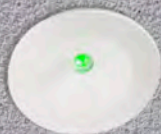

EMPOWER3 RECESSED LED EMERGENCY DOWNLIGHT

- Supplied with compact energy efficient Li-ion battery
- Suitable for non-maintained use only
- Aluminium, white, and black bezels included

Construction: Die-cast aluminium

Lamp type: LED



WHITE AND BLACK BEZEL INCLUDED

Overall Ø	Minimum Void	Cut-out Ø (mm)
42	75	34



Code	Wattage	Model	Colour	CCT	Emergency Lumens	
EMPOWER3	3W	3-hour	Daylight	6000K	120lm	NEW

EMPOWER RECESSED LED EMERGENCY DOWNLIGHT

- Aluminium body with aluminium, white, and black bezels
- Green LED indicates when downlight is in charging mode
- Supplied pre-wired
- Inverter and battery pack included
- Suitable for non-maintained use only
- **EMPOWERST ONLY:** Self-test facility in accordance to EN 62034

Construction: Die-cast aluminium

Lamp type: LED



Overall Ø	Minimum Void	Cut-out Ø (mm)
42	75	34



Code	Wattage	Model	Colour	CCT	Emergency Lumens	
EMPOWERST	3W	Self-test - 3-hour	Daylight	6000K	120lm	NEW
EMPOWER	3W	3-hour	Daylight	6000K	120lm	

EMPOWER2 RECESSED LED EMERGENCY DOWNLIGHT

- Separate green LED indicates when light is in charging mode
- Supplied pre-wired
- Low-profile inverter and battery pack included
- Suitable for maintained or non-maintained use

Construction: Die-cast aluminium

Lamp type: LED



Overall Ø	Minimum Void	Cut-out Ø (mm)
55	80	46

Code	Wattage	Model	Colour	CCT	Emergency Lumens
EMPOWER2	3W	3-hour	Daylight	6000K	210lm
EMPOWERW2	3W	3-hour	Warm White	3000K	145lm

HIGH LUMEN RECESSED LED EMERGENCY DOWNLIGHT

- Dual status LED - illuminates green whilst charging and converts to white LED when power is lost
- Inverter and battery pack included
- Ideal for corridors, stairwells, and a variety of commercial and public areas
- Suitable for non-maintained use only

Construction: Die-cast aluminium

Lamp type: LED



Overall Ø	Minimum Void	Cut-out Ø (mm)
68	97	55

Code	Wattage	Model	Colour	CCT	Emergency Lumens
ENM5	5W	3-hour	Daylight	6000K	340lm

ADAPTABLE EMERGENCY LED DOWNLIGHT

- Slimline, low-profile design, supplied with Hole convertor for ease of use
- Adjustable trim with two cut-out diameters
- Inverter and battery pack included
- Manual test button
- Suitable for non-maintained use only

Construction: Polycarbonate

Lamp type: LED



Overall Ø	Minimum Void	Cut-out Ø	(mm)	230V 50Hz	IP20		 LAMP INCLUDED	3 YEAR WARRANTY	
140	80	70-130							
Code	Wattage	Model	Colour	CCT	Emergency Lumens				
EMPDL	3W	3-hour	Daylight	5500K	130lm				

LED SURFACE EMERGENCY DOWNLIGHT

- Surface mounted
- Ideal for commercial and residential use
- Suitable for non-maintained use only

Construction: Polycarbonate

Lamp type: LED



Overall Ø	Projection	(mm)	230V 50Hz	IP20		 LAMP INCLUDED	3 YEAR WARRANTY	
118	50							
Code	Wattage	Model	Colour	CCT	Emergency Lumens			
EMSUR	3W	3-hour	Daylight	6000K	135lm			

CPL DOWNLIGHT EMERGENCY KIT

- Compatible with 6W / 12W / 18W / 24W CPL fittings
- Inverter and battery pack included
- Pre-wired with easy-fix connectors and LED charge indicator
- CPL luminaire not included

Construction: Polycarbonate

Length	Height	Width	(mm)
211	24	34	

Code	Model	
CPLEM	3-hour LED Emergency Pack	NEW



LED 3-HOUR EMERGENCY KIT

- Converts LED luminaires to 3-hour emergency 50W max.
- Maintained and non-maintained use
- Suitable for Knightsbridge products: LEDPAN38/PLxxLED/ MRBLED/ CRDLxx

Construction: Polycarbonate

Height	Length	Width	(mm)
32	225	60	

Code	Model
EMKIT2	LED (Constant Current) Emergency Kit



GU10 LED EMERGENCY KIT

- Pre-wired with easy-fix connectors and LED charge indicator
- For maintained and non-maintained use

Construction: Polycarbonate

Lamp type: GU10 LED (6W max.)

Min. Cut-out Ø	(mm)
55	

Code	Model	Finish
EMGUKIT1	LED Emergency Pack	White





SEE PAGES 243-260
FOR OUTDOOR
WALL LIGHTS

SENSORS

Our range of sensors offers solutions to a variety of lighting requirements both indoor and outdoor, suitable for commercial and domestic applications

Indoor Sensors	362-363
Microwave Sensors	363
Outdoor Sensors	364
Photocell Sensors / Batten Microwave Sensor	365



OS0016



OS0019



OS009

RECESS MOUNTED INDOOR PIR SENSORS

Field of detection: 360°

230V
50Hz

IP20

Code	Range*	Function	Max. Load	Cut-out
OS0016	2-20m	Adjustable Lux / Adjustable Time (10s - 10mins)	2000W Incandescent / 1000W LED	80mm
OS0019	8m	Adjustable Lux / Adjustable Time (30s - 30mins)	2000W Incandescent / 200W LED	38mm
OS009	6m	Adjustable Lux / Adjustable Time (10s - 8mins)	1200W Incandescent / 300W LED	62mm

SURFACE MOUNTED INDOOR PIR SENSOR

Field of detection: 360°



230V
50Hz

IP20

Code	Range*	Function	Max. Load
OS0011	6m	Adjustable Lux / Adjustable Time (10s - 8mins)	1200W Incandescent / 300W LED

FLUSH FIX / SURFACE MOUNT INDOOR PIR SENSORS

- Minimum mounting box depth 25mm



230V
50Hz

IP20

Field of detection: 120° (must have L and N feed)

Code	Range*	Function	Max. Load
PIR0901	5m	Adjustable Lux / Adjustable Time (1-16mins)	2400W Incandescent / 720W LED
PIR0901S	5m	Adjustable Lux / Adjustable Time (1-16mins) with override switch	2400W Incandescent / 720W LED

* When mounted at 2.4 metres high

MICROWAVE SENSORS

- These products should be installed into an IP rated enclosure or luminaire



MSENSOR



OS008

230V
50Hz

IP20

Code	Model	Range	Function	Max. Load	Type
MSENSOR	5.8GHz	2-8m	Adjustable Lux / Adjustable Time (10s - 30m)	1000W Incandescent 500W LED	Dial setting
OS008	5.8GHz	2-8m	Adjustable Lux / Adjustable Time (8s - 12mins)	250W Incandescent 250W LED	DIP Switch Setting

CORNER MOUNTABLE

OUTDOOR PIR SENSORS

- Completely adjustable head unit for optimum positioning
- Easy to install – wire to the rear mounting plate then simply click the PIR unit into the mounting plate
- Versatile mounting options including wall, ceiling, or corner mounting
- Includes shrouding kit for shielding parts of the PIR to prevent accidental activation
- Automatic operation or manual override function



230V
50Hz

IP55

Field of detection: 200°

Code	Range*	Function	Max. Load	Colour
OS001	12m	Override function / Adjustable Lux Adjustable Time (3s - 30mins)	2000W Incandescent / 225W LED	White
OS001B	12m	Override function / Adjustable Lux Adjustable Time (3s - 30mins)	2000W Incandescent / 225W LED	Black

OUTDOOR PIR SENSORS

- Adjustable head unit (up / down)
- Wall or ceiling mountable



230V
50Hz

IP44

Field of detection: 180°

Code	Range*	Function	Max. Load	Colour
OS004	12m	Adjustable Lux / Adjustable Time (10s - 8mins)	1200W Incandescent / 300W LED	White
OS004B	12m	Adjustable Lux / Adjustable Time (10s - 8mins)	1200W Incandescent / 300W LED	Black

OUTDOOR PIR SENSORS (COMPACT)

- Adjustable head unit
- Wall or ceiling mountable



230V
50Hz

IP44

Field of detection: 180°

Code	Range*	Function	Max. Load	Colour
OS0014	12m	Adjustable Lux / Adjustable Time (10s - 15mins)	2000W Incandescent 1000W LED	White
OS0014B	12m	Adjustable Lux / Adjustable Time (10s - 15mins)	2000W Incandescent 1000W LED	Black

* When mounted at 2.4 metres high

OUTDOOR PHOTOCELL SENSOR

- Dusk-to-dawn photocell timer. Ideal for controlling outdoor lighting during the evenings for security and convenience
- Suitable for shop window display lighting or advertising systems
- Wall mountable - easy installation



230V
50Hz

IP55

Code	Function	Max. Load	Colour
OS006	Ambient Light Memory Function - 2/4/6/8hr durations	1000W Incandescent / 200W LED	White



230V
50Hz

PHOTOCELL SENSORS

Code	Function	IP Rating	Max. Load	Colour
TRPCKIT	NEMA Photocell Kit - Dusk-to-Dawn Sensor	IP54	2000W Tungsten Halogen, 2 x 400W SON 3 x 150W HQL, 1800vA	Black
TRRPC	Remote Miniature Photocell	IP65	2000W Tungsten Halogen, 2 x 400W SON 3 x 150W HQL, 1800vA	Black

BATTEN MICROWAVE SENSOR

- IP65 pre-wired microwave sensor
- Ideal for battens or non-corrosives with 20mm conduit entry
- Adjustable lux, time, and sensitivity



Code	Function	Range*	Max. Load	
OS020	Adjustable Lux / Adjustable Time (5s - 10mins)	4-6m	400W LED	NEW



LAMPS & LIGHTING ACCESSORIES

The everyday lighting essentials including lamps, drivers, fuses, screws, and more

E27/E40 LED Corn Lamps	368
LED GU10 Lamps	369
LED Filament Lamps	370
G4 & G9 LED Capsule Lamps	371
G9 Halogen Capsule Lamps / Tungsten Halogen Lamps	372
2D Lamp / LED Gear Tray	373
PL Lamps / T8 LED Tubes / GX53 LED Lamp	374
Waterproof Junction Box / Transformer / LED Drivers	375
LED Dimmable Drivers / 12V IP67 LED Driver	376
24V IP67 LED Driver / Suction Cup / Spring Clips / Lamp Holders	377
Strip Connectors / Fuses / Screws / Blanking Plug	378



See page
268
for E27
BOLLARDS



CRN12CW



CRN36CW



CRN54CW

E27 / E40 CORN LAMPS

- Suitable for indoor use or enclosed outdoor luminaires
- Integral cooling system maximising LED operation
- Suitable for open and closed fixtures
- 360° light distribution

Construction: Polycarbonate
Lamp type: LED
Beam angle: 179°

230V
50Hz

IP20



5
YEAR
WARRANTY

Code	Wattage	Lamp Base	CCT	Lumens	Height	
CRN12CW	12W	E27	4000K	1695lm	128mm	NEW
CRN18CW	18W	E27	4000K	2495lm	148mm	NEW
CRN27CW	27W	E27	4000K	3750lm	173mm	NEW
CRN36CW	36W	E40	4000K	5115lm	216mm	NEW
CRN54CW	54W	E40	4000K	6870lm	255mm	NEW

CoB LED GU10 LAMPS

- Retrofit replacement for most GU10 halogen lamps.
Similar look and feel to that of traditional halogen light source

Construction: Glass
Lamp type: LED
Beam angle: 38°

230V
50Hz



GUC5WW



GUC5CW



GUC5DL

Code	Wattage	Model	Colour	CCT	Lumens	Qty
GUC5DWW	5W	Dimmable	Warm White	3000K	385lm	20
GUC5DCW	5W	Dimmable	Cool White	4000K	425lm	20
GUC5DDL	5W	Dimmable	Daylight	6000K	385lm	20
GUC5WW	5W	Non-Dimmable	Warm White	3000K	410lm	20
GUC5CW	5W	Non-Dimmable	Cool White	4000K	455lm	20
GUC5DL	5W	Non-Dimmable	Daylight	6000K	415lm	20

SMD LED GU10 LAMPS

Construction: Aluminium & Polycarbonate
Lamp type: LED
Beam angle: 36°

230V
50Hz



GU5LDWW



GU5LDCW



GU5LDDL

Code	Wattage	Model	Colour	CCT	Lumens	Qty
GU5LDWW	5W	Dimmable	Warm White	3000K	400lm	20
GU5LDCW	5W	Dimmable	Cool White	4000K	440lm	20
GU5LDDL	5W	Dimmable	Daylight	6000K	450lm	20
GU5LWW	5W	Non-Dimmable	Warm White	3000K	380lm	20
GU5LCW	5W	Non-Dimmable	Cool White	4000K	415lm	20
GU5LDL	5W	Non-Dimmable	Daylight	6000K	430lm	20

SMD LED GU10 LAMPS WITH WIDE BEAM

- Retrofit replacement for most GU10 halogen lamps

Construction: Ceramic
Lamp type: LED
Beam angle: 120°

230V
50Hz



GUSM5WW



GUSM5CW



GUSM5DL

Code	Wattage	Colour	CCT	Lumens	Qty
GUSM5WW	5W	Warm White	2700K	410lm	20
GUSM5CW	5W	Cool White	4000K	450lm	20
GUSM5DL	5W	Daylight	6000K	455lm	20



LED FILAMENT LAMPS



CLD4BCC



CLD4ESC



CLD4SBCC



CLD4SESC



CLD4SESO



CLD6SESC



CLD6ESC

230V
50Hz



CLEAR / FROSTED CANDLE

Code	Wattage	Model	Lamp Type	Colour	CCT	Height	Overall Ø	Lumens	
CLD4BCC	4W	Clear Candle	BC	Warm White	2700K	91mm	35mm	430lm	NEW
CLD4ESC	4W	Clear Candle	ES	Warm White	2700K	93mm	35mm	430lm	NEW
CLD4SBCC	4W	Clear Candle	SBC	Warm White	2700K	95mm	35mm	430lm	NEW
CLD4SESC	4W	Clear Candle	SES	Warm White	2700K	97mm	35mm	430lm	NEW
CLD4SESO	4W	Frosted Candle	SES	Warm White	2700K	97mm	35mm	400lm	NEW
CLD6ESC	6W	Clear Candle	ES	Warm White	2700K	93mm	35mm	630lm	NEW
CLD6SESC	6W	Clear Candle	SES	Warm White	2700K	97mm	35mm	630lm	NEW



GBD4ESC



GBD4SESC

230V
50Hz



GOLF BALL

Code	Wattage	Model	Lamp Type	Colour	CCT	Height	Overall Ø	Lumens	
GBD4ESC	4W	Clear Golf Ball	ES	Warm White	2700K	72mm	45mm	430lm	NEW
GBD4SESC	4W	Clear Golf Ball	SES	Warm White	2700K	78mm	45mm	430lm	NEW



GLSD8BCC



GLSD8ESC

230V
50Hz



CLEAR GLS

Code	Wattage	Model	Lamp Type	Colour	CCT	Height	Overall Ø	Lumens	
GLSD8BCC	8W	Clear GLS	BC	Warm White	2700K	103mm	60mm	890lm	NEW
GLSD8ESC	8W	Clear GLS	ES	Warm White	2700K	105mm	60mm	890lm	NEW



12V G4 BASE LED CAPSULE LAMPS

- Suitable for use with AC and DC

Construction: Thermoplastic & Copper/Silicone (G4LED3 and G4LED4)

Lamp type: LED

12V



Code	Wattage	Colour	CCT	Height	Overall Ø	Lumens	Qty
G4LED1	1.5W	Warm White	2700K	32mm	10.2mm	110lm	10
G4LED2	1.5W	Cool White	4000K	32mm	10.2mm	120lm	10
G4LED3	2W	Warm White	2700K	37mm	13mm	150lm	10
G4LED4	3W	Warm White	2700K	42mm	16mm	200lm	10



G9 BASE LED CAPSULE LAMPS

- Suitable replacement for most G9 halogen lamps
- Dimmable where stated

Lamp type: LED

230V
50Hz

Code	Wattage	Model	Colour	CCT	Height	Overall Ø	Lumens	Qty
G9LED6	4W	Dimmable	Warm White	2700K	50mm	16mm	220lm	10
G9LED7	4W	Dimmable	Cool White	4000K	50mm	16mm	280lm	10
G9LED8	4W	Non-Dimmable	Warm White	2700K	50mm	16mm	370lm	10
G9LED9	4W	Non-Dimmable	Cool White	4000K	50mm	16mm	370lm	10
G9LED10	2W	Non-Dimmable	Warm White	3000K	43mm	16mm	200lm	10
G9LED11	2W	Non-Dimmable	Cool White	4000K	43mm	16mm	200lm	10
G9LED14	3.5W	Dimmable	Warm White	2700K	55.5mm	18.5mm	470lm	10
G9LED15	3.5W	Dimmable	Cool White	4000K	55.5mm	18.5mm	510lm	10

G9 BASE ENERGY SAVER HALOGEN CAPSULE LAMPS

Construction: Glass
Lamp type: G9 Halogen



230V
50Hz



Code	Wattage	Colour	CCT	Height	Overall Ø	Lumens	Qty
G918W	18W	Warm White	2900K	41mm	13mm	200lm	20
G928W	28W	Warm White	2900K	41mm	13mm	370lm	20
G942W	42W	Warm White	2900K	41mm	13mm	620lm	20

TUNGSTEN HALOGEN ENERGY SAVING LAMPS

Construction: Glass & Ceramic
Lamp type: R7s



110V

230V
50Hz



Code	Wattage	Model	Colour	CCT	Length	Overall Ø	Qty
L80	80W	230V	Warm White	2900K	78mm	8mm	50
L110	500W	110V	Warm White	2900K	118mm	12.2mm	50
L120	120W	230V	Warm White	2900K	78mm	8mm	50
L160	160W	230V	Warm White	2900K	118mm	10mm	50
L230	230W	230V	Warm White	2900K	118mm	10mm	50
L400	400W	230V	Warm White	2900K	118mm	10mm	50
L1000	1000W	230V	Warm White	2900K	190mm	12.2mm	50



2D WHITE ENERGY EFFICIENT LAMP

Construction: Glass

Lamp type: Fluorescent

230V
50Hz



Code	Wattage	Model	Colour	CCT	Qty
2D16W2P	16W	2 Pin	White	3500K	10
2D16W4P	16W	4 Pin	White	3500K	10
2D28W4P	28W	4 Pin	White	3500K	10

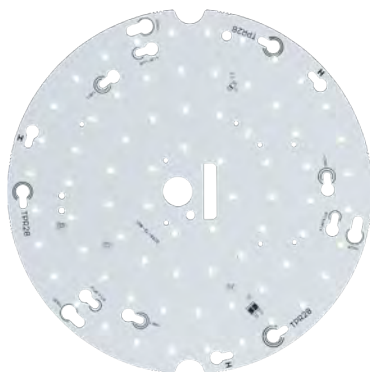

LED GEAR TRAY

- Replacement for 2D 28W fittings
- High output

Construction: CEM-1

Lamp type: SMD LED

230V
50Hz



3
YEAR
WARRANTY

Code	Wattage	Model	Colour	CCT	Overall Ø
BPLED	14W	Standard	Cool White	4000K	246mm
BPLEDEM	14W	Emergency	Cool White	4000K	246mm
BPLEDS	14W	Sensor	Cool White	4000K	246mm
BPLEDEMS	14W	Emergency + Sensor	Cool White	4000K	246mm



PL LAMPS

Construction: Glass
Lamp type: Fluorescent



230V
50Hz



Code	Wattage	Model	Colour	CCT	Height	Overall Ø	Qty
PL18W4P	18W	4 Pin G24q-2	Cool White	4000K	141mm	33mm	20
PL26W4P	26W	4 Pin G24q-3	Cool White	4000K	161mm	33mm	20

T8 LED TUBES

- Alternative to classic T8 fluorescent lamps
- Up to 130lm/W
- Instant ignition provides uniform illumination
- Integral driver for ease of installation
- Not for use with external electronic or magnetic ballasts



230V
50Hz



Lamp type: LED

Code	Wattage	Construction	Colour	CCT	Length	Overall Ø	Lumens	Qty
T8LEDP9CW	9W	Glass	Cool White	4000K	603mm	27mm	1090lm	4 NEW
T8LEDP9DL	9W	Glass	Daylight	6000K	603mm	27mm	1080lm	4 NEW
T8LEDP18CW	18W	Glass	Cool White	4000K	1212mm	27mm	2295lm	4 NEW
T8LEDP18DL	18W	Glass	Daylight	6000K	1212mm	27mm	2230lm	4 NEW
T8LEDP24CW	24W	Glass	Cool White	4000K	1512mm	27mm	2980lm	4 NEW
T8LEDP24DL	24W	Glass	Daylight	6000K	1512mm	27mm	2895lm	4 NEW

T8LED6	30W	Polycarbonate	Cool White	4000K	1778mm	26mm	3350lm	1
T8LED6D	30W	Polycarbonate	Daylight	6000K	1778mm	26mm	3400lm	1

GX53 LED LAMP

Construction: Polycarbonate & Acrylic
Lamp type: LED



230V
50Hz



Code	Wattage	Colour	CCT	Height	Overall Ø	Lumens
GXLED3K	5W	Warm White	3000K	26mm	75mm	400lm
GXLED5K	5W	Daylight	5000K	26mm	75mm	430lm

IP68 WATERPROOF JUNCTION BOX

- To be wired in series (refer to diagram)

Code	Model
IP68JBS	Max. load 48V DC 20W

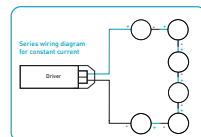

TRANSFORMER T02

- Dimmable, thermal overload, and short circuit protection

Code	Model	Length	Width	Height
T02	20W - 60W	120mm	30mm	23mm
T03	35W - 105W	123mm	39mm	28mm



12V IP20 CONSTANT VOLTAGE LED DRIVER

Code	Model	Length	Width	Height
12VDCA	12V 12W	98mm	39mm	22mm
12DC36	12V 36W	125mm	55mm	30mm
12DC40	12V 40W	166mm	52mm	24mm
12DC60	12V 60W	113mm	45mm	47mm



24V IP20 CONSTANT VOLTAGE LED DRIVER

Code	Model	Length	Width	Height
24VDCA	24V 12W	98mm	36mm	22mm
24DC36	24V 36W	125mm	55mm	30mm
24DC40	24V 40W	166mm	52mm	24mm
24DC60	24V 60W	113mm	45mm	47mm
24DC100A	24V 100W	160mm	100mm	40mm
24DC150A	24V 150W	200mm	100mm	40mm
24DC200A	24V 200W	200mm	110mm	50mm





IP20 CONSTANT CURRENT LED DRIVERS

- Compatible with most trailing-edge dimmers (dimmable models)

Code	Model	Length	Width	Height	
1W350DA	18-35V 350mA 12W (dimmable)	98mm	39mm	22mm	
1W210DA	12-40V 350mA 16.5W (dimmable)	125mm	41mm	29mm	NEW
1W350A	2-34V 350mA 12W (non-dimmable)	98mm	39mm	22mm	
25W350DA	36-72V 350mA 25W (dimmable)	120mm	45mm	28mm	NEW
25W700DA	18-36V 700mA 25W (dimmable)	120mm	45mm	28mm	NEW
40W700DA	28-56V 700mA 40W (dimmable)	166mm	52mm	25mm	NEW

12V IP20 CONSTANT VOLTAGE DIMMABLE LED DRIVER

- Compatible with most trailing-edge dimmers

Code	Model	Length	Width	Height
12DC25D	12V 25W	128mm	52mm	30mm
12DC50D	12V 50W	184mm	61mm	32mm



24V IP20 CONSTANT VOLTAGE DIMMABLE LED DRIVER

- Compatible with most trailing-edge dimmers

Code	Model	Length	Width	Height
24DC25D	24V 25W	128mm	52mm	30mm
24DC50D	24V 50W	184mm	61mm	32mm
24DC100D	24V 100W	210mm	67mm	34mm



12V IP67 CONSTANT VOLTAGE LED DRIVER

Code	Model	Length	Width	Height
12DCIP36	12V 36W	222mm	30mm	20mm



24V IP67 CONSTANT VOLTAGE LED DRIVER



Code	Model	Length	Width	Height
24DCIP36	24V 36W	222mm	30mm	20mm
24DCIP60	24V 60W	168mm	50mm	33mm
24DCIP100	24V 100W	165mm	70mm	43mm



RUBBER SUCTION CUP

- For easy changing of GU10 halogen lamps

Code	Model	Qty
LSC1	Rubber Suction Cup	10



SPRING CLIPS FOR LOW VOLTAGE FITTINGS

Code	Model	Qty
LVC1	50mm	100
LVC2	35mm	100

LAMP HOLDERS

Code	Model	Qty
LH01	Low Voltage with 180mm Silicon Cable	50
LH01C	Low Voltage with 180mm Silicon Cable and Metal Clip	50
LH02	GU10 with 260mm Silicon Cable	50
LH03	GU10 with Bridge and Separate Earth Terminal	50
LH04	Low Voltage with Bridge	50



LH01C



LH02



LH03



LH04



STRIP CONNECTORS

- 380V terminal strips for connecting electrical cable
- 12-Way terminal block
- Made with PA66 material (UL94-V2 self extinguishing) EN 60947, operating temperature: -30°C to +110°C

Code	Model	Qty
SC3PA	3A	10
SC5PA	5A	10
SC15PA	15A	10
SC30PA	30A	10
SC60PA	60A	10



FUSES (ASTA Approved)

Code	Model	Qty
SN3AFUSE	3A	10
SN5AFUSE	5A	10
SN13AFUSE	13A	10
SNMIXEDFUSE	Mixed Pack (3 x 3A, 3 x 5A, 4 x 13A)	10

RAISED-HEAD ELECTRICAL FIXING SCREWS

- Ideal for use with Square, Curved, or Raised Edge Ranges

Code	Model	Qty
CSCREW35	M3.5 x 35mm Nickel	100
CSCREW50	M3.5 x 50mm Nickel	100
CSCREW75	M3.5 x 75mm Nickel	100



FLAT-HEAD ELECTRICAL FIXING SCREWS

- Ideal for use with the Screwless and Flat Plate ranges

Code	Model	Qty
C-SCREW50B	M3.5 x 50mm Brass	100
C-SCREW50N	M3.5 x 50mm Nickel	100
C-SCREW50BK	M3.5 x 50mm Black Nickel and Gunmetal	100



BLANKING PLUG

Code	Model	Qty
1390	Blanking Plug	5

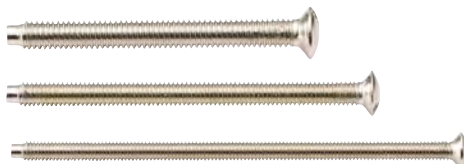



WEATHERPROOF
SWITCHES PAGE 134



SMART SWITCHED
SOCKET PAGE 164

Just a few of the new products from

Knightsbridge



DUAL-MOUNTING
CCT LED PANEL
DOWNLIGHTS PAGE 311



INTERCHANGABLE
ROUND LED
WALL LIGHT PAGE 253



INDEX

NO.			
Code	Catalogue Section	Qty	Page
1350	Wiring Basics	10	147
1375	Wiring Basics	10	147
1390	Wiring Basics	5	147
8261	Wiring Basics	1	145
8910	Wiring Basics	20	147
12DC25D	LED Flex	1	237
12DC36	LED Flex	1	237
12DC40	LED Flex	1	237
12DC50D	LED Flex	1	237
12DC60	LED Flex	1	237
12DCIP36	LED Flex	1	237
12GTOWER	Wiring Basics	1	146
12VDCA	LED Flex	1	237
132A	Wiring Basics	20	148
1GAKW	Smart Home	1	165
1G5BBK	Wiring Basics	1	143
1G5BGY	Wiring Basics	1	143
1G5BW	Wiring Basics	1	143
1IPB	Groundlights & Deck Lighting	1	277
1IPW	Groundlights & Deck Lighting	1	277
1MPRF	LED Flex	1	234
1MPSC	LED Flex	1	234
1MPSF	LED Flex	1	234
1SPIKE38	Outdoor Wall Lights	1	260
1W210DA	Lamps & Lighting Accessories	1	376
1W350A	Lamps & Lighting Accessories	1	376
1W350DA	Lamps & Lighting Accessories	1	376
1WALL38	Outdoor Wall Lights	1	260
20042M	Wiring Basics	1	146
20043M	Wiring Basics	1	146
2004S2M	Wiring Basics	1	146
20062M	Wiring Basics	1	146
2006S2M	Wiring Basics	1	146
2135-RB	Wiring Basics	20	148
2135-RW	Wiring Basics	20	148
24DC100A	LED Flex	1	237
24DC100D	LED Flex	1	237
24DC150A	LED Flex	1	237
24DC200A	LED Flex	1	237
24DC25D	LED Flex	1	237
24DC36	LED Flex	1	237
24DC40	LED Flex	1	237
24DC50D	LED Flex	1	237
24DC60	LED Flex	1	237
24DCIP100	LED Flex	1	237
24DCIP36	LED Flex	1	237
24DCIP60	LED Flex	1	237
24VDCA	Lamps & Lighting Accessories	1	375
25W350DA	Lamps & Lighting Accessories	1	376
25W700DA	Lamps & Lighting Accessories	1	376
2D16W2P	Lamps & Lighting Accessories	10	373
2D16W4P	Lamps & Lighting Accessories	10	373
2D28W4P	Lamps & Lighting Accessories	10	373
2GPHBK	Raised Edge - Rounded	1	26
2GPHGY	Raised Edge - Rounded	1	26
2GPHW	Raised Edge - Rounded	1	26

NO.			
Code	Catalogue Section	Qty	Page
2SPIKE38	Outdoor Wall Lights	1	260
2WALL38	Outdoor Wall Lights	1	260
316WALK	Groundlights & Deck Lighting	1	272
3GKW	Smart Home	1	165
40W700DA	Lamps & Lighting Accessories	1	376
4IPB	Groundlights & Deck Lighting	1	277
4IPW	Groundlights & Deck Lighting	1	277
5401A	Outdoor Wall Lights	1	256
5FTT5KIT	Recessed, Surface & Suspension	1	320
8270AB	Wiring Basics	1	144
8270BC	Wiring Basics	1	144
8270BN	Wiring Basics	1	144
8270MB	Wiring Basics	1	145
8270MW	Wiring Basics	1	144
8270PB	Wiring Basics	1	144
8270PC	Wiring Basics	1	144
8271AB	Wiring Basics	1	145
8271BC	Wiring Basics	1	145
8271BN	Wiring Basics	1	145
8271PB	Wiring Basics	1	145
8271PC	Wiring Basics	1	145
8300AB	Wiring Basics	1	145
8300BC	Wiring Basics	1	145
8300BN	Wiring Basics	1	145
8300MB	Wiring Basics	1	145
8300MW	Wiring Basics	1	145
8300PC	Wiring Basics	1	145
8GTOWER	Wiring Basics	1	146

A.			
Code	Catalogue Section	Qty	Page
AC65118	Non-corrosive	1	337
AC65136	Non-corrosive	1	337
AC65136EM	Non-corrosive	1	337
AC65158	Non-corrosive	1	337
AC651581	Non-corrosive	1	337
AC651581EM	Non-corrosive	1	337
AC65158EM	Non-corrosive	1	337
AC65170	Non-corrosive	1	337
AC65170EM	Non-corrosive	1	337
AC65218	Non-corrosive	1	337
AC65236	Non-corrosive	1	337
AC65236EM	Non-corrosive	1	337
AC65258	Non-corrosive	1	337
AC652581	Non-corrosive	1	337
AC652581EM	Non-corrosive	1	337
AC65258EM	Non-corrosive	1	337
AC65270	Non-corrosive	1	337
AC65270EM	Non-corrosive	1	337
AMLEDB	Bulkheads & Wall Packs	1	305
AMLEDBS	Bulkheads & Wall Packs	1	305
AMLEDR	Bulkheads & Wall Packs	1	305
AMLEDW	Bulkheads & Wall Packs	1	305
AMLEDWS	Bulkheads & Wall Packs	1	305
AV2	Datacomms	1	124
AV6	Datacomms	1	124
AV7	Datacomms	1	124

A.			
Code	Catalogue Section	Qty	Page
AV8	Datacomms	1	124
B.			
Code	Catalogue Section	Qty	Page
BATC4	Battens	1	332
BATC4EM	Battens	1	332
BATC5	Battens	1	332
BATC5EM	Battens	1	332
BATC5EMH	Battens	1	332
BATC5H	Battens	1	332
BATC5S	Battens	1	332
BATC6	Battens	1	332
BATC6EM	Battens	1	332
BATC6EMH	Battens	1	332
BATC6H	Battens	1	332
BATC6S	Battens	1	332
BATS2	Battens	1	330
BATS4	Battens	1	330
BATS4EM	Battens	1	330
BATS4S	Battens	1	330
BATS5	Battens	1	330
BATS5EM	Battens	1	330
BATS5EMH	Battens	1	331
BATS5EMS	Battens	1	330
BATS5H	Battens	1	331
BATS5S	Battens	1	330
BATS6	Battens	1	331
BATS6EM	Battens	1	331
BATS6EMH	Battens	1	331
BATS6EMS	Battens	1	331
BATS6H	Battens	1	331
BATS6S	Battens	1	331
BF1430	Bulkheads & Wall Packs	1	301
BF1430EM	Bulkheads & Wall Packs	1	301
BF1430EMS	Bulkheads & Wall Packs	1	301
BF1430S	Bulkheads & Wall Packs	1	301
BF14BBR	Bulkheads & Wall Packs	1	301
BF14BCHR	Bulkheads & Wall Packs	1	301
BF14BMS	Bulkheads & Wall Packs	1	301
BF14BWH	Bulkheads & Wall Packs	1	301
BF14L4K	Bulkheads & Wall Packs	1	301
BF2440	Bulkheads & Wall Packs	1	301
BF2440EM	Bulkheads & Wall Packs	1	301
BF2440EMS	Bulkheads & Wall Packs	1	301
BF2440S	Bulkheads & Wall Packs	1	301
BF24BBR	Bulkheads & Wall Packs	1	301
BF24BCHR	Bulkheads & Wall Packs	1	301
BF24BMS	Bulkheads & Wall Packs	1	301
BF24BWH	Bulkheads & Wall Packs	1	301
BF24L4K	Bulkheads & Wall Packs	1	301
BH22BC	Bulkheads & Wall Packs	1	304
BH22PB	Bulkheads & Wall Packs	1	304
BL01BK	Outdoor Wall Lights	1	254
BL12LED	Bulkheads & Wall Packs	1	295
BL12LEDE	Bulkheads & Wall Packs	1	295
BL12LEDS	Bulkheads & Wall Packs	1	295
BL20LED	Bulkheads & Wall Packs	1	295

B.			
Code	Catalogue Section	Qty	Page
BL20LEDE	Bulkheads & Wall Packs	1	295
BL20LEDS	Bulkheads & Wall Packs	1	295
BLED5BB	Outdoor Wall Lights	1	254
BLED5BW	Outdoor Wall Lights	1	254
BLED5SB	Outdoor Wall Lights	1	254
BLED5SW	Outdoor Wall Lights	1	254
BPLED	Bulkheads & Wall Packs	1	294
BPLEDEM	Bulkheads & Wall Packs	1	294
BPLEDEMS	Lamps & Lighting Accessories	1	373
BPLEDS	Lamps & Lighting Accessories	1	373
BT14B	Bulkheads & Wall Packs	1	298
BT14CHR	Bulkheads & Wall Packs	1	298
BT14CT	Bulkheads & Wall Packs	1	297
BT14CTA	Bulkheads & Wall Packs	1	297
BT14CTEM	Bulkheads & Wall Packs	1	297
BT14CTEMA	Bulkheads & Wall Packs	1	297
BT14CTEMS	Bulkheads & Wall Packs	1	297
BT14CTS	Bulkheads & Wall Packs	1	297
BT14EB	Bulkheads & Wall Packs	1	298
BT14EG	Bulkheads & Wall Packs	1	298
BT14ES	Bulkheads & Wall Packs	1	298
BT14G	Bulkheads & Wall Packs	1	298
BT14MBR	Bulkheads & Wall Packs	1	298
BT14SLV	Bulkheads & Wall Packs	1	298
BT20B	Bulkheads & Wall Packs	1	298
BT20CHR	Bulkheads & Wall Packs	1	298
BT20CT	Bulkheads & Wall Packs	1	297
BT20CTA	Bulkheads & Wall Packs	1	297
BT20CTEM	Bulkheads & Wall Packs	1	297
BT20CTEMA	Bulkheads & Wall Packs	1	297
BT20CTEMS	Bulkheads & Wall Packs	1	297
BT20CTS	Bulkheads & Wall Packs	1	297
BT20G	Bulkheads & Wall Packs	1	298
BT20MBR	Bulkheads & Wall Packs	1	298
BT20SLV	Bulkheads & Wall Packs	1	298
BT9B	Bulkheads & Wall Packs	1	298
BT9CHR	Bulkheads & Wall Packs	1	298
BT9CT	Bulkheads & Wall Packs	1	297
BT9CTEM	Bulkheads & Wall Packs	1	297
BT9CTEMS	Bulkheads & Wall Packs	1	297
BT9CTS	Bulkheads & Wall Packs	1	297
BT9EB	Bulkheads & Wall Packs	1	298
BT9EG	Bulkheads & Wall Packs	1	298
BT9ES	Bulkheads & Wall Packs	1	298
BT9G	Bulkheads & Wall Packs	1	298
BT9MBR	Bulkheads & Wall Packs	1	298
BT9SLV	Bulkheads & Wall Packs	1	298
BWLED1	Bathroom	1	211
BWLED10	Bathroom	1	211
BWLED2	Bathroom	1	211
BWLED4	Bathroom	1	208
BWLED6	Bathroom	1	210
BWLED7	Bathroom	1	210
BWLED9	Bathroom	1	208
CABBCW	Under Cabinet	1	224
CABBCWW	Under Cabinet	1	224

C.			
Code	Catalogue Section	Qty	Page
CABCCW	Under Cabinet	1	224
CABCWW	Under Cabinet	1	224
CABWCW	Under Cabinet	1	224
CABWWW	Under Cabinet	1	224
CAPWGU	Groundlights & Deck Lighting	1	273
CENCONF	LED Flex	1	236
CENCONS	LED Flex	1	236
CFR5CW	Downlights	1	185
CFR5WW	Downlights	1	185
CFRB	Downlights	1	185
CFRBC	Downlights	1	185
CFRPC	Downlights	1	185
CFRW	Downlights	1	185
CL010BC	Raised Edge - Rounded	1	32
CL010PC	Raised Edge - Rounded	1	32
CL014BC	Raised Edge - Rounded	1	33
CL014PC	Raised Edge - Rounded	1	33
CL015BC	Raised Edge - Rounded	1	33
CL015PC	Raised Edge - Rounded	1	33
CL11BC	Raised Edge - Rounded	1	28
CL11PC	Raised Edge - Rounded	1	28
CL12BC	Raised Edge - Rounded	1	28
CL12PC	Raised Edge - Rounded	1	28
CL1GBC	Raised Edge - Rounded	1	33
CL1GPC	Raised Edge - Rounded	1	33
CL2181BC	Raised Edge - Rounded	1	30
CL2181PC	Raised Edge - Rounded	1	30
CL2182BC	Raised Edge - Rounded	1	30
CL2182PC	Raised Edge - Rounded	1	30
CL2183BC	Raised Edge - Rounded	1	30
CL2183PC	Raised Edge - Rounded	1	30
CL2184BC	Raised Edge - Rounded	1	30
CL2184PC	Raised Edge - Rounded	1	30
CL2BC	Raised Edge - Rounded	1	28
CL2GBC	Raised Edge - Rounded	1	33
CL2GPC	Raised Edge - Rounded	1	33
CL2PC	Raised Edge - Rounded	1	28
CL3BC	Raised Edge - Rounded	1	28
CL3PC	Raised Edge - Rounded	1	28
CL41BC	Raised Edge - Rounded	1	28
CL41PC	Raised Edge - Rounded	1	28
CL42BC	Raised Edge - Rounded	1	28
CL42PC	Raised Edge - Rounded	1	28
CL45BC	Raised Edge - Rounded	1	32
CL45PC	Raised Edge - Rounded	1	32
CL4BC	Raised Edge - Rounded	1	28
CL4GBC	Raised Edge - Rounded	1	33
CL4GPC	Raised Edge - Rounded	1	33
CL4PC	Raised Edge - Rounded	1	28
CL5ABC	Raised Edge - Rounded	1	28
CL5ABCG	Raised Edge - Rounded	1	28
CL5ABCW	Raised Edge - Rounded	1	28
CL5APC	Raised Edge - Rounded	1	28
CL5APCG	Raised Edge - Rounded	1	28
CL5APCW	Raised Edge - Rounded	1	28
CL63BC	Raised Edge - Rounded	1	31

C.			
Code	Catalogue Section	Qty	Page
CL63FBC	Raised Edge - Rounded	1	31
CL63FPC	Raised Edge - Rounded	1	31
CL63NBC	Raised Edge - Rounded	1	31
CL63NPC	Raised Edge - Rounded	1	31
CL63PC	Raised Edge - Rounded	1	31
CL6BC	Raised Edge - Rounded	1	31
CL6PC	Raised Edge - Rounded	1	31
CL73BC	Raised Edge - Rounded	1	32
CL73PC	Raised Edge - Rounded	1	32
CL74BC	Raised Edge - Rounded	1	32
CL74PC	Raised Edge - Rounded	1	32
CL7BC	Raised Edge - Rounded	1	26
CL7BCG	Raised Edge - Rounded	1	26
CL7BCW	Raised Edge - Rounded	1	26
CL7PC	Raised Edge - Rounded	1	26
CL7PCG	Raised Edge - Rounded	1	26
CL7PCW	Raised Edge - Rounded	1	26
CL81NBC	Raised Edge - Rounded	1	31
CL81NPC	Raised Edge - Rounded	1	31
CL82NBC	Raised Edge - Rounded	1	32
CL82NPC	Raised Edge - Rounded	1	32
CL834BC	Raised Edge - Rounded	1	31
CL834FBC	Raised Edge - Rounded	1	31
CL834FPC	Raised Edge - Rounded	1	31
CL834NBC	Raised Edge - Rounded	1	31
CL834NPC	Raised Edge - Rounded	1	31
CL834PC	Raised Edge - Rounded	1	31
CL83BC	Raised Edge - Rounded	1	32
CL83BCG	Raised Edge - Rounded	1	32
CL83BCW	Raised Edge - Rounded	1	32
CL83PC	Raised Edge - Rounded	1	32
CL83PCG	Raised Edge - Rounded	1	32
CL83PCW	Raised Edge - Rounded	1	32
CL85BC	Raised Edge - Rounded	1	33
CL85PC	Raised Edge - Rounded	1	33
CL86BC	Raised Edge - Rounded	1	33
CL86PC	Raised Edge - Rounded	1	33
CL89BC	Raised Edge - Rounded	1	27
CL89BCG	Raised Edge - Rounded	1	27
CL89BCW	Raised Edge - Rounded	1	27
CL89PC	Raised Edge - Rounded	1	27
CL89PCG	Raised Edge - Rounded	1	27
CL89PCW	Raised Edge - Rounded	1	27
CL91BC	Raised Edge - Rounded	1	27
CL91BCG	Raised Edge - Rounded	1	27
CL91BCW	Raised Edge - Rounded	1	27
CL91PC	Raised Edge - Rounded	1	27
CL91PCG	Raised Edge - Rounded	1	27
CL91PCW	Raised Edge - Rounded	1	27
CL9224BC	Raised Edge - Rounded	1	26
CL9224BCG	Raised Edge - Rounded	1	26
CL9224BCW	Raised Edge - Rounded	1	26
CL9224PC	Raised Edge - Rounded	1	26
CL9224PCG	Raised Edge - Rounded	1	26
CL9224PCW	Raised Edge - Rounded	1	26
CL9BC	Raised Edge - Rounded	1	26

C.			
Code	Catalogue Section	Qty	Page
CL9BCG	Raised Edge - Rounded	1	26
CL9BCW	Raised Edge - Rounded	1	26
CL9PC	Raised Edge - Rounded	1	26
CL9PCG	Raised Edge - Rounded	1	26
CL9PCW	Raised Edge - Rounded	1	26
CLD4BCC	Lamps & Lighting Accessories	1	370
CLD4ESC	Lamps & Lighting Accessories	1	370
CLD4SBCC	Lamps & Lighting Accessories	1	370
CLD4SESC	Lamps & Lighting Accessories	1	370
CLD4SESO	Lamps & Lighting Accessories	1	370
CLD6ESC	Lamps & Lighting Accessories	1	370
CLD6SESC	Lamps & Lighting Accessories	1	370
CLIP1	Non-corrosive	20	337
CLTOG12BC	Raised Edge - Rounded	1	29
CLTOG12PC	Raised Edge - Rounded	1	29
CLTOG1BC	Raised Edge - Rounded	1	29
CLTOG1PC	Raised Edge - Rounded	1	29
CLTOG2BC	Raised Edge - Rounded	1	29
CLTOG2PC	Raised Edge - Rounded	1	29
CLTOG3BC	Raised Edge - Rounded	1	29
CLTOG3PC	Raised Edge - Rounded	1	29
CLTOG4BC	Raised Edge - Rounded	1	29
CLTOG4PC	Raised Edge - Rounded	1	29
CON2P	LED Flex	1	236
CONFLEX2P	LED Flex	1	236
CONFLEX3P	LED Flex	1	236
CONFLEX4P	LED Flex	1	236
CONFLEX5P	LED Flex	1	236
CONFLEXCHS	LED Flex	1	236
CONIP2P	LED Flex	1	236
CONIP3P	LED Flex	1	236
CONIP4P	LED Flex	1	236
CONIP5P	LED Flex	1	236
CONT2P	LED Flex	1	236
CONX2P	LED Flex	1	236
CPL12BC	Commercial Downlights	1	311
CPL12CT	Commercial Downlights	1	311
CPL12MB	Commercial Downlights	1	311
CPL12PC	Commercial Downlights	1	311
CPL18BC	Commercial Downlights	1	311
CPL18CT	Commercial Downlights	1	311
CPL18MB	Commercial Downlights	1	311
CPL18PC	Commercial Downlights	1	311
CPL18WCT	Smart Home	1	169
CPL24BC	Commercial Downlights	1	311
CPL24CT	Commercial Downlights	1	311
CPL24MB	Commercial Downlights	1	311
CPL24PC	Commercial Downlights	1	311
CPL24WCT	Smart Home	1	169
CPL6BC	Commercial Downlights	1	311
CPL6CT	Commercial Downlights	1	311
CPL6MB	Commercial Downlights	1	311
CPL6PC	Commercial Downlights	1	311
CPLEM	Emergency	1	359
CRDL10	Commercial Downlights	1	313
CRDL15	Commercial Downlights	1	313

C.			
Code	Catalogue Section	Qty	Page
CRDL20	Commercial Downlights	1	313
CRDL30	Commercial Downlights	1	313
CRF02B	Under Cabinet	1	225
CRF02C	Under Cabinet	1	225
CRF02CBR	Under Cabinet	1	225
CRF02W	Under Cabinet	1	225
CRN12CW	Lamps & Lighting Accessories	1	368
CRN18CW	Lamps & Lighting Accessories	1	368
CRN27CW	Lamps & Lighting Accessories	1	368
CRN36CW	Lamps & Lighting Accessories	1	368
CRN54CW	Lamps & Lighting Accessories	1	368
CRN54W	Lamps & Lighting Accessories	1	368
CS010AB	Raised Edge - Square	1	47
CS010BC	Raised Edge - Square	1	47
CS014AB	Raised Edge - Square	1	48
CS014BC	Raised Edge - Square	1	48
CS015AB	Raised Edge - Square	1	48
CS015BC	Raised Edge - Square	1	48
CS11AB	Raised Edge - Square	1	43
CS11BC	Raised Edge - Square	1	43
CS12AB	Raised Edge - Square	1	44
CS12BC	Raised Edge - Square	1	44
CS1GAB	Raised Edge - Square	1	48
CS1GBC	Raised Edge - Square	1	48
CS2181AB	Raised Edge - Square	1	45
CS2181BC	Raised Edge - Square	1	45
CS2182AB	Raised Edge - Square	1	45
CS2182BC	Raised Edge - Square	1	45
CS2183AB	Raised Edge - Square	1	45
CS2183BC	Raised Edge - Square	1	45
CS2184AB	Raised Edge - Square	1	45
CS2184BC	Raised Edge - Square	1	45
CS2AB	Raised Edge - Square	1	44
CS2BC	Raised Edge - Square	1	44
CS2GAB	Raised Edge - Square	1	48
CS2GBC	Raised Edge - Square	1	48
CS3AB	Raised Edge - Square	1	44
CS3BC	Raised Edge - Square	1	44
CS41AB	Raised Edge - Square	1	44
CS41BC	Raised Edge - Square	1	44
CS42AB	Raised Edge - Square	1	44
CS42BC	Raised Edge - Square	1	44
CS45AB	Raised Edge - Square	1	47
CS45BC	Raised Edge - Square	1	47
CS4AB	Raised Edge - Square	1	44
CS4BC	Raised Edge - Square	1	44
CS4GAB	Raised Edge - Square	1	47
CS4GBC	Raised Edge - Square	1	47
CS5AAB	Raised Edge - Square	1	43
CS5ABC	Raised Edge - Square	1	43
CS5ABCG	Raised Edge - Square	1	43
CS5ABCW	Raised Edge - Square	1	43
CS63AB	Raised Edge - Square	1	46
CS63BC	Raised Edge - Square	1	46
CS63FAB	Raised Edge - Square	1	46
CS63FBC	Raised Edge - Square	1	46

C.

Code	Catalogue Section	Qty	Page
CS63NAB	Raised Edge - Square	1	46
CS63NBC	Raised Edge - Square	1	46
CS6AB	Raised Edge - Square	1	46
CS6BC	Raised Edge - Square	1	46
CS73AB	Raised Edge - Square	1	47
CS73BC	Raised Edge - Square	1	47
CS74AB	Raised Edge - Square	1	47
CS74BC	Raised Edge - Square	1	47
CS7AB	Raised Edge - Square	1	40
CS7BC	Raised Edge - Square	1	40
CS7BCG	Raised Edge - Square	1	40
CS7BCW	Raised Edge - Square	1	40
CS7USB4BC	Raised Edge - Square	1	42
CS7USB4BCG	Raised Edge - Square	1	42
CS7USB4BCW	Raised Edge - Square	1	42
CS81NAB	Raised Edge - Square	1	46
CS81NBC	Raised Edge - Square	1	46
CS82NAB	Raised Edge - Square	1	47
CS82NBC	Raised Edge - Square	1	47
CS834AB	Raised Edge - Square	1	47
CS834BC	Raised Edge - Square	1	47
CS834FAB	Raised Edge - Square	1	46
CS834FBC	Raised Edge - Square	1	46
CS834NAB	Raised Edge - Square	1	46
CS834NBC	Raised Edge - Square	1	46
CS83AB	Raised Edge - Square	1	47
CS83BC	Raised Edge - Square	1	47
CS83BCG	Raised Edge - Square	1	47
CS83BCW	Raised Edge - Square	1	47
CS85AB	Raised Edge - Square	1	48
CS85BC	Raised Edge - Square	1	48
CS86AB	Raised Edge - Square	1	48
CS86BC	Raised Edge - Square	1	48
CS89AB	Raised Edge - Square	1	43
CS89BC	Raised Edge - Square	1	43
CS89BCG	Raised Edge - Square	1	43
CS89BCW	Raised Edge - Square	1	43
CS91AB	Raised Edge - Square	1	40
CS91BC	Raised Edge - Square	1	40
CS91BCG	Raised Edge - Square	1	40
CS91BCW	Raised Edge - Square	1	40
CS9224AB	Raised Edge - Square	1	40
CS9224BC	Raised Edge - Square	1	40
CS9224BCG	Raised Edge - Square	1	40
CS9224BCW	Raised Edge - Square	1	40
CS9905BC	Raised Edge - Square	1	42
CS9905BCG	Raised Edge - Square	1	42
CS9905BCW	Raised Edge - Square	1	42
CS9906BC	Raised Edge - Square	1	41
CS9906BCG	Raised Edge - Square	1	41
CS9906BCW	Raised Edge - Square	1	41
CS9907BC	Raised Edge - Square	1	41
CS9907BCG	Raised Edge - Square	1	41
CS9907BCW	Raised Edge - Square	1	41
CS9AB	Raised Edge - Square	1	40
CS9BC	Raised Edge - Square	1	40

C.

Code	Catalogue Section	Qty	Page
CS9BCG	Raised Edge - Square	1	40
CS9BCW	Raised Edge - Square	1	40
CSBLUEBC	Raised Edge - Square	1	42
CSCREW35	Wiring Basics	100	148
CSCREW50	Wiring Basics	100	148
C-SCREW50B	Flat Plate	100	72
C-SCREW50BK	Flat Plate	100	72
C-SCREW50N	Flat Plate	100	72
CSCREW75	Wiring Basics	100	148
CSQUADBC	Raised Edge - Square	1	42
CSQUADBCG	Raised Edge - Square	1	42
CSQUADBCW	Raised Edge - Square	1	42
CSTOG12AB	Raised Edge - Square	1	45
CSTOG12BC	Raised Edge - Square	1	45
CSTOG1AB	Raised Edge - Square	1	45
CSTOG1BC	Raised Edge - Square	1	45
CSTOG2AB	Raised Edge - Square	1	45
CSTOG2BC	Raised Edge - Square	1	45
CSTOG3AB	Raised Edge - Square	1	45
CSTOG3BC	Raised Edge - Square	1	45
CSTOG4AB	Raised Edge - Square	1	45
CSTOG4BC	Raised Edge - Square	1	45
CU0100	Moulded Curved Edge	1	18
CU0110	Moulded Curved Edge	1	18
CU0120	Moulded Curved Edge	1	18
CU0140	Moulded Curved Edge	1	18
CU0150	Moulded Curved Edge	1	18
CU1000	Moulded Curved Edge	1	16
CU1100	Moulded Curved Edge	1	16
CU1200	Moulded Curved Edge	1	16
CU1200M	Moulded Curved Edge	1	16
CU1300	Moulded Curved Edge	10	18
CU1400	Moulded Curved Edge	10	18
CU1500	Moulded Curved Edge	5	18
CU1600	Moulded Curved Edge	5	18
CU1610	Moulded Curved Edge	10	18
CU1700	Moulded Curved Edge	10	18
CU1800	Moulded Curved Edge	5	18
CU1DIM	Moulded Curved Edge	1	16
CU1G	Moulded Curved Edge	1	18
CU2000	Moulded Curved Edge	1	16
CU2161	Moulded Curved Edge	1	16
CU2162	Moulded Curved Edge	1	16
CU2163	Moulded Curved Edge	1	16
CU2164	Moulded Curved Edge	1	16
CU298MM	Moulded Curved Edge	1	15
CU2DIM	Moulded Curved Edge	1	16
CU2G	Moulded Curved Edge	1	18
CU3000	Moulded Curved Edge	1	16
CU4000	Moulded Curved Edge	1	16
CU4100	Moulded Curved Edge	1	16
CU4101	Moulded Curved Edge	1	16
CU4200	Moulded Curved Edge	1	16
CU4G	Moulded Curved Edge	1	18
CU5U	Moulded Curved Edge	1	15
CU6000	Moulded Curved Edge	1	16

C.			
Code	Catalogue Section	Qty	Page
CU6000-3A	Moulded Curved Edge	1	16
CU6000N	Moulded Curved Edge	1	16
CU6300	Moulded Curved Edge	1	16
CU6300F	Moulded Curved Edge	1	16
CU6300N	Moulded Curved Edge	1	16
CU7000	Moulded Curved Edge	1	14
CU7000S	Moulded Curved Edge	1	14
CU7000U	Moulded Curved Edge	1	14
CU7300	Moulded Curved Edge	1	18
CU7400	Moulded Curved Edge	1	18
CU8331	Moulded Curved Edge	1	17
CU8331N	Moulded Curved Edge	1	17
CU8331NW	Moulded Curved Edge	1	17
CU8331W	Moulded Curved Edge	1	17
CU8332	Moulded Curved Edge	1	17
CU8332N	Moulded Curved Edge	1	17
CU8332NW	Moulded Curved Edge	1	17
CU8332W	Moulded Curved Edge	1	17
CU8333	Moulded Curved Edge	1	17
CU8333N	Moulded Curved Edge	1	17
CU8333NW	Moulded Curved Edge	1	17
CU8333W	Moulded Curved Edge	1	17
CU8340	Moulded Curved Edge	1	17
CU8341	Moulded Curved Edge	1	17
CU8341N	Moulded Curved Edge	1	17
CU8342	Moulded Curved Edge	1	17
CU8350	Moulded Curved Edge	1	18
CU8360	Moulded Curved Edge	1	18
CU8900N	Moulded Curved Edge	1	15
CU9000	Moulded Curved Edge	1	14
CU9000S	Moulded Curved Edge	1	14
CU9000U	Moulded Curved Edge	1	14
CU9903	Moulded Curved Edge	1	14
CU9904	Moulded Curved Edge	1	14
CU9931C	Moulded Curved Edge	1	14
CU9948	Moulded Curved Edge	1	14
CUBOIL	Moulded Curved Edge	1	21
CUDISH	Moulded Curved Edge	1	21
CUDRY	Moulded Curved Edge	1	21
CUFAN	Moulded Curved Edge	1	21
CUFRID	Moulded Curved Edge	1	21
CUG1	Moulded Curved Edge	1	19
CUG12	Moulded Curved Edge	1	19
CUG1F	Moulded Curved Edge	1	19
CUG2	Moulded Curved Edge	1	19
CUG2F	Moulded Curved Edge	1	19
CUG3	Moulded Curved Edge	1	19
CUG4	Moulded Curved Edge	1	19
CUG6	Moulded Curved Edge	1	19
CUG8	Moulded Curved Edge	1	19
CUGM1	Moulded Curved Edge	1	20
CUGM10	Moulded Curved Edge	1	20
CUGM11	Moulded Curved Edge	1	21
CUGM12	Moulded Curved Edge	1	21
CUGM13	Moulded Curved Edge	1	21
CUGM14	Moulded Curved Edge	1	20

C.			
Code	Catalogue Section	Qty	Page
CUGM15	Moulded Curved Edge	1	21
CUGM16	Moulded Curved Edge	1	21
CUGM17	Moulded Curved Edge	1	21
CUGM2	Moulded Curved Edge	1	20
CUGM3	Moulded Curved Edge	1	20
CUGM4	Moulded Curved Edge	1	20
CUGM5	Moulded Curved Edge	1	20
CUGM6	Moulded Curved Edge	1	20
CUGM7	Moulded Curved Edge	1	20
CUGM8	Moulded Curved Edge	1	20
CUGM9	Moulded Curved Edge	1	20
CUHOB	Moulded Curved Edge	1	21
CUHOOD	Moulded Curved Edge	1	21
CUMICR10	Moulded Curved Edge	1	21
CUOVEN	Moulded Curved Edge	1	21
CUWASH	Moulded Curved Edge	1	21
CWL1	Bathroom	1	208
CWL2	Bathroom	1	208
D.			
Code	Catalogue Section	Qty	Page
DC001	Additional Hardware	1	156
DC002	Additional Hardware	1	156
DC003	Additional Hardware	1	156
DC006	Additional Hardware	1	157
DC007	Additional Hardware	1	157
E.			
Code	Catalogue Section	Qty	Page
E27PC	Bulkheads & Wall Packs	1	304
E27PR	Bulkheads & Wall Packs	1	304
EMEXIT	Emergency	1	354
EMEXITL2	Emergency	1	354
EMEXITL3	Emergency	1	354
EMEXITLR	Emergency	1	354
EMGUKIT1	Downlights	1	176
EMKIT2	Emergency	1	359
EMLED1	Emergency	1	350
EMLED2A	Emergency	1	351
EMLED3	Emergency	1	350
EMLED4	Emergency	1	350
EMLED5	Emergency	1	351
EMLREC	Emergency	1	355
EMLSUS	Emergency	1	355
EMPDL	Emergency	1	358
EMPOWER	Emergency	1	356
EMPOWER2	Emergency	1	356
EMPOWER3	Emergency	1	356
EMPOWERST	Emergency	1	359
EMPOWERW2	Emergency	1	356
EMRNST	Emergency	1	352
EMRUN	Emergency	1	352
EMRUND	Emergency	1	352
EMRUNL	Emergency	1	352
EMRUNR	Emergency	1	352
EMRUNU	Emergency	1	352
EMSUR	Emergency	1	358
EMSWING	Emergency	1	353



E.

Code	Catalogue Section	Qty	Page
EMSWINGD	Emergency	1	353
EMSWINGLR	Emergency	1	353
EMTWIN	Emergency	1	349
EMTWINIP	Emergency	1	348
EMTWINPC	Emergency	1	349
EMTWINST	Emergency	1	348
EMXST	Emergency	1	354
ENM5	Emergency	1	357
EVOABF	Downlights	1	182
EVOABT	Downlights	1	183
EVOBCF	Downlights	1	182
EVOBCT	Downlights	1	183
EVOBKF	Downlights	1	182
EVOBKT	Downlights	1	183
EVOBRF	Downlights	1	182
EVOBRT	Downlights	1	183
EVOCBC	Downlights	1	182
EVOCC	Downlights	1	182
EVOCHF	Downlights	1	182
EVOCHT	Downlights	1	183
EVOCW	Downlights	1	182
EVOGMF	Downlights	1	182
EVOGMT	Downlights	1	183
EVOICF	Downlights	1	182
EVOICT	Downlights	1	183
EVOIPBC	Downlights	1	182
EVOIPCH	Downlights	1	182
EVOIPWH	Downlights	1	182
EVOWHF	Downlights	1	182
EVOWHT	Downlights	1	183
EX001T	Additional Hardware	1	159
EX003T	Additional Hardware	1	158
EX004H	Additional Hardware	1	158
EX004T	Additional Hardware	1	158
EX005T	Additional Hardware	1	158
EX007B	Additional Hardware	1	159
EX007W	Additional Hardware	1	159
EX009B	Additional Hardware	1	159
EX009W	Additional Hardware	1	159
EX4DUCT	Additional Hardware	1	159
EXT2	Spike Lights	1	265
EXT3	Spike Lights	1	265

F.

Code	Catalogue Section	Qty	Page
FL16BK	Floodlights	1	286
FL16W	Floodlights	1	286
FL8BK	Floodlights	1	286
FL8W	Floodlights	1	286
FLEXCON	LED Flex	1	236
FLEXFIX	LED Flex	1	236
FLEXFIXL	LED Flex	1	236
FLF10RGB	Floodlights	1	285
FLF20RGB	Floodlights	1	285
FLF30RGB	Floodlights	1	285
FLF50RGB	Floodlights	1	285
FLN10	Floodlights	1	282

F.

Code	Catalogue Section	Qty	Page
FLN20	Floodlights	1	282
FLN30	Floodlights	1	282
FLN50	Floodlights	1	282
FLNMC	Floodlights	1	282
FLNPIR	Floodlights	1	282
FLP100	Floodlights	1	284
FLP100A	Floodlights	1	284
FLP150	Floodlights	1	284
FLP150A	Floodlights	1	284
FLP200	Floodlights	1	284
FLP200A	Floodlights	1	284
FLR10	Floodlights	1	283
FLR10P	Floodlights	1	283
FLR20	Floodlights	1	283
FLR20P	Floodlights	1	283
FLR30	Floodlights	1	283
FLR30P	Floodlights	1	283
FLR50	Floodlights	1	283
FLR50P	Floodlights	1	283
FLTB	Floodlights	1	287
FLTPB	Floodlights	1	287
FLTPW	Floodlights	1	287
FLTW	Floodlights	1	287
FP0100BB	Flat Plate	1	69
FP0100BC	Flat Plate	1	69
FP0100GM	Flat Plate	1	69
FP0100PB	Flat Plate	1	69
FP0100PC	Flat Plate	1	69
FP0100PL	Flat Plate	1	69
FP0140BB	Flat Plate	1	70
FP0140BC	Flat Plate	1	70
FP0140GM	Flat Plate	1	70
FP0140PB	Flat Plate	1	70
FP0140PC	Flat Plate	1	70
FP0140PL	Flat Plate	1	70
FP0150BB	Flat Plate	1	70
FP0150BC	Flat Plate	1	70
FP0150GM	Flat Plate	1	70
FP0150PB	Flat Plate	1	70
FP0150PC	Flat Plate	1	70
FP0150PL	Flat Plate	1	70
FP1100BB	Flat Plate	1	62
FP1100BC	Flat Plate	1	62
FP1100GM	Flat Plate	1	62
FP1100PB	Flat Plate	1	62
FP1100PC	Flat Plate	1	62
FP1100PL	Flat Plate	1	62
FP1200BB	Flat Plate	1	62
FP1200BC	Flat Plate	1	62
FP1200GM	Flat Plate	1	62
FP1200PB	Flat Plate	1	62
FP1200PC	Flat Plate	1	62
FP1200PL	Flat Plate	1	62
FP12TOGGB	Flat Plate	1	64
FP12TOGBC	Flat Plate	1	64
FP12TOGGM	Flat Plate	1	64

F.				F.			
Code	Catalogue Section	Qty	Page	Code	Catalogue Section	Qty	Page
FP12TOGPB	Flat Plate	1	64	FP3000BB	Flat Plate	1	63
FP12TOGPC	Flat Plate	1	64	FP3000BC	Flat Plate	1	63
FP12TOGPL	Flat Plate	1	64	FP3000GM	Flat Plate	1	63
FP1GBB	Flat Plate	1	71	FP3000PB	Flat Plate	1	63
FP1GBC	Flat Plate	1	71	FP3000PC	Flat Plate	1	63
FP1GGM	Flat Plate	1	71	FP3000PL	Flat Plate	1	63
FP1GPB	Flat Plate	1	71	FP3TOGBB	Flat Plate	1	64
FP1GPC	Flat Plate	1	71	FP3TOGBC	Flat Plate	1	64
FP1GPL	Flat Plate	1	71	FP3TOGGM	Flat Plate	1	64
FP1TOGBB	Flat Plate	1	64	FP3TOGPB	Flat Plate	1	64
FP1TOGBC	Flat Plate	1	64	FP3TOGPC	Flat Plate	1	64
FP1TOGGM	Flat Plate	1	64	FP3TOGPL	Flat Plate	1	64
FP1TOGPB	Flat Plate	1	64	FP4000BB	Flat Plate	1	63
FP1TOGPC	Flat Plate	1	64	FP4000BC	Flat Plate	1	63
FP1TOGPL	Flat Plate	1	64	FP4000GM	Flat Plate	1	63
FP2000BB	Flat Plate	1	62	FP4000PB	Flat Plate	1	63
FP2000GM	Flat Plate	1	62	FP4000PC	Flat Plate	1	63
FP2000PB	Flat Plate	1	62	FP4000PL	Flat Plate	1	63
FP2000PC	Flat Plate	1	62	FP4100BB	Flat Plate	1	63
FP2000PL	Flat Plate	1	62	FP4100BC	Flat Plate	1	63
FP2181BB	Flat Plate	1	65	FP4100GM	Flat Plate	1	63
FP2181BC	Flat Plate	1	65	FP4100PB	Flat Plate	1	63
FP2181GM	Flat Plate	1	65	FP4100PC	Flat Plate	1	63
FP2181PB	Flat Plate	1	65	FP4100PL	Flat Plate	1	63
FP2181PC	Flat Plate	1	65	FP4200BB	Flat Plate	1	63
FP2181PL	Flat Plate	1	65	FP4200BC	Flat Plate	1	63
FP2182BB	Flat Plate	1	65	FP4200GM	Flat Plate	1	63
FP2182BC	Flat Plate	1	65	FP4200PB	Flat Plate	1	63
FP2182GM	Flat Plate	1	65	FP4200PC	Flat Plate	1	63
FP2182PB	Flat Plate	1	65	FP4200PL	Flat Plate	1	63
FP2182PC	Flat Plate	1	65	FP4GBB	Flat Plate	1	71
FP2182PL	Flat Plate	1	65	FP4GBC	Flat Plate	1	71
FP2183BB	Flat Plate	1	65	FP4GGM	Flat Plate	1	71
FP2183BC	Flat Plate	1	65	FP4GPB	Flat Plate	1	71
FP2183GM	Flat Plate	1	65	FP4GPC	Flat Plate	1	71
FP2183PB	Flat Plate	1	65	FP4GPL	Flat Plate	1	71
FP2183PC	Flat Plate	1	65	FP4TOGBB	Flat Plate	1	64
FP2183PL	Flat Plate	1	65	FP4TOGBC	Flat Plate	1	64
FP2184BB	Flat Plate	1	65	FP4TOGGM	Flat Plate	1	64
FP2184BC	Flat Plate	1	65	FP4TOGPB	Flat Plate	1	64
FP2184GM	Flat Plate	1	65	FP4TOGPC	Flat Plate	1	64
FP2184PB	Flat Plate	1	65	FP4TOGPL	Flat Plate	1	64
FP2184PC	Flat Plate	1	65	FP5ABB	Flat Plate	1	62
FP2184PL	Flat Plate	1	65	FP5ABC	Flat Plate	1	62
FP2GBB	Flat Plate	1	71	FP5ABCG	Flat Plate	1	62
FP2GBC	Flat Plate	1	71	FP5ABCW	Flat Plate	1	62
FP2GGM	Flat Plate	1	71	FP5AGM	Flat Plate	1	62
FP2GPB	Flat Plate	1	71	FP5APB	Flat Plate	1	62
FP2GPC	Flat Plate	1	71	FP5APC	Flat Plate	1	62
FP2GPL	Flat Plate	1	71	FP5APCG	Flat Plate	1	62
FP2TOGBB	Flat Plate	1	64	FP5APCW	Flat Plate	1	62
FP2TOGBC	Flat Plate	1	64	FP5APLW	Flat Plate	1	62
FP2TOGGM	Flat Plate	1	64	FP6000BB	Flat Plate	1	66
FP2TOGPB	Flat Plate	1	64	FP6000BC	Flat Plate	1	66
FP2TOGPC	Flat Plate	1	64	FP6000GM	Flat Plate	1	66
FP2TOGPL	Flat Plate	1	64	FP6000PB	Flat Plate	1	66



F.

Code	Catalogue Section	Qty	Page
FP6000PC	Flat Plate	1	66
FP6000PL	Flat Plate	1	66
FP6300BC	Flat Plate	1	66
FP6300FBB	Flat Plate	1	66
FP6300FBC	Flat Plate	1	66
FP6300FGM	Flat Plate	1	66
FP6300FPB	Flat Plate	1	66
FP6300FPC	Flat Plate	1	66
FP6300FPL	Flat Plate	1	66
FP6300GM	Flat Plate	1	66
FP6300NBB	Flat Plate	1	66
FP6300NBC	Flat Plate	1	66
FP6300NGM	Flat Plate	1	66
FP6300NPB	Flat Plate	1	66
FP6300NPC	Flat Plate	1	66
FP6300NPL	Flat Plate	1	66
FP6300PB	Flat Plate	1	66
FP6300PC	Flat Plate	1	66
FP6300PL	Flat Plate	1	66
FP7300BB	Flat Plate	1	69
FP7300BC	Flat Plate	1	69
FP7300GM	Flat Plate	1	69
FP7300PB	Flat Plate	1	69
FP7300PC	Flat Plate	1	69
FP7300PL	Flat Plate	1	69
FP7400BB	Flat Plate	1	69
FP7400BC	Flat Plate	1	69
FP7400GM	Flat Plate	1	69
FP7400PB	Flat Plate	1	69
FP7400PC	Flat Plate	1	69
FP7400PL	Flat Plate	1	69
FP8331NBB	Flat Plate	1	68
FP8331NBC	Flat Plate	1	68
FP8331NGM	Flat Plate	1	68
FP8331NPB	Flat Plate	1	68
FP8331NPC	Flat Plate	1	68
FP8331NPL	Flat Plate	1	68
FP8332NBB	Flat Plate	1	68
FP8332NBC	Flat Plate	1	68
FP8332NGM	Flat Plate	1	68
FP8332NPB	Flat Plate	1	68
FP8332NPC	Flat Plate	1	68
FP8332NPL	Flat Plate	1	68
FP8341BB	Flat Plate	1	67
FP8341BC	Flat Plate	1	67
FP8341FBB	Flat Plate	1	67
FP8341FBC	Flat Plate	1	67
FP8341FGM	Flat Plate	1	67
FP8341FPB	Flat Plate	1	67
FP8341FPC	Flat Plate	1	67
FP8341FPL	Flat Plate	1	67
FP8341GM	Flat Plate	1	67
FP8341NBB	Flat Plate	1	67
FP8341NBC	Flat Plate	1	67
FP8341NGM	Flat Plate	1	67
FP8341NPB	Flat Plate	1	67

F.

Code	Catalogue Section	Qty	Page
FP8341NPC	Flat Plate	1	67
FP8341NPL	Flat Plate	1	67
FP8341PB	Flat Plate	1	67
FP8341PC	Flat Plate	1	67
FP8341PL	Flat Plate	1	67
FP8350BB	Flat Plate	1	70
FP8350BC	Flat Plate	1	70
FP8350GM	Flat Plate	1	70
FP8350PB	Flat Plate	1	70
FP8350PC	Flat Plate	1	70
FP8350PL	Flat Plate	1	70
FP8360BB	Flat Plate	1	70
FP8360BC	Flat Plate	1	70
FP8360GM	Flat Plate	1	70
FP8360PB	Flat Plate	1	70
FP8360PC	Flat Plate	1	70
FP8360PL	Flat Plate	1	70
FP8900BB	Flat Plate	1	61
FP8900BC	Flat Plate	1	61
FP8900BCG	Flat Plate	1	61
FP8900BCW	Flat Plate	1	61
FP8900GM	Flat Plate	1	61
FP8900PB	Flat Plate	1	61
FP8900PC	Flat Plate	1	61
FP8900PCG	Flat Plate	1	61
FP8900PCW	Flat Plate	1	61
FP8900PLW	Flat Plate	1	61
FPQUADBB	Flat Plate	1	60
FPQUADBC	Flat Plate	1	60
FPQUADBCG	Flat Plate	1	60
FPQUADBCW	Flat Plate	1	60
FPQUADGM	Flat Plate	1	60
FPQUADPB	Flat Plate	1	60
FPQUADPC	Flat Plate	1	60
FPQUADPCG	Flat Plate	1	60
FPQUADPCW	Flat Plate	1	60
FPQUADPLW	Flat Plate	1	60
FPR7000BB	Flat Plate	1	56
FPR7000BC	Flat Plate	1	56
FPR7000BCG	Flat Plate	1	56
FPR7000BCW	Flat Plate	1	56
FPR7000GM	Flat Plate	1	56
FPR7000PB	Flat Plate	1	56
FPR7000PC	Flat Plate	1	56
FPR7000PCG	Flat Plate	1	56
FPR7000PCW	Flat Plate	1	56
FPR7000PLW	Flat Plate	1	56
FPR7UBBW	Flat Plate	1	57
FPR7UBCW	Flat Plate	1	57
FPR7UPBW	Flat Plate	1	57
FPR7UPCW	Flat Plate	1	57
FPR7USB4BB	Flat Plate	1	59
FPR7USB4BC	Flat Plate	1	59
FPR7USB4BCG	Flat Plate	1	59
FPR7USB4BCW	Flat Plate	1	59
FPR7USB4GM	Flat Plate	1	59

F.			
Code	Catalogue Section	Qty	Page
FPR7USB4PB	Flat Plate	1	59
FPR7USB4PC	Flat Plate	1	59
FPR7USB4PCG	Flat Plate	1	59
FPR7USB4PCW	Flat Plate	1	59
FPR7USB4PLW	Flat Plate	1	59
FPR8333NBB	Flat Plate	1	68
FPR8333NBC	Flat Plate	1	68
FPR8333NBCG	Flat Plate	1	68
FPR8333NBCW	Flat Plate	1	68
FPR8333NMG	Flat Plate	1	68
FPR8333NPB	Flat Plate	1	68
FPR8333NPC	Flat Plate	1	68
FPR8333NPCG	Flat Plate	1	68
FPR8333NPCW	Flat Plate	1	68
FPR8333NPLW	Flat Plate	1	68
FPR9000BB	Flat Plate	1	56
FPR9000BC	Flat Plate	1	56
FPR9000BCG	Flat Plate	1	56
FPR9000BCW	Flat Plate	1	56
FPR9000GM	Flat Plate	1	56
FPR9000PB	Flat Plate	1	56
FPR9000PC	Flat Plate	1	56
FPR9000PCG	Flat Plate	1	56
FPR9000PCW	Flat Plate	1	56
FPR9000PLW	Flat Plate	1	56
FPR9224BB	Flat Plate	1	57
FPR9224BC	Flat Plate	1	57
FPR9224BCG	Flat Plate	1	57
FPR9224BCW	Flat Plate	1	57
FPR9224GM	Flat Plate	1	57
FPR9224PB	Flat Plate	1	57
FPR9224PC	Flat Plate	1	57
FPR9224PCG	Flat Plate	1	57
FPR9224PCW	Flat Plate	1	57
FPR9224PLW	Flat Plate	1	57
FPR9901BB	Flat Plate	1	58
FPR9901BC	Flat Plate	1	58
FPR9901BCG	Flat Plate	1	58
FPR9901BCW	Flat Plate	1	58
FPR9901GM	Flat Plate	1	58
FPR9901PB	Flat Plate	1	58
FPR9901PC	Flat Plate	1	58
FPR9901PCG	Flat Plate	1	58
FPR9901PCW	Flat Plate	1	58
FPR9901PLW	Flat Plate	1	58
FPR9904NBC	Flat Plate	1	58
FPR9904NBCG	Flat Plate	1	58
FPR9904NBCW	Flat Plate	1	58
FPR9905BC	Flat Plate	1	60
FPR9905BCG	Flat Plate	1	60
FPR9905BCW	Flat Plate	1	60
FPR9UBBW	Flat Plate	1	57
FPR9UBCW	Flat Plate	1	57
FPR9UPBW	Flat Plate	1	57
FPR9UPCW	Flat Plate	1	57
FPRJ45BB	Flat Plate	1	69

F.			
Code	Catalogue Section	Qty	Page
FPRJ45BC	Flat Plate	1	69
FPRJ45GM	Flat Plate	1	69
FPRJ45PB	Flat Plate	1	69
FPRJ45PC	Flat Plate	1	69
FPRJ45PL	Flat Plate	1	69
FR1200	Recessed, Surface & Suspension	1	318
FR150	Downlights	1	176
FR600	Recessed, Surface & Suspension	1	318
G.			
Code	Catalogue Section	Qty	Page
G4LED1	Lamps & Lighting Accessories	10	371
G4LED2	Lamps & Lighting Accessories	10	371
G4LED3	Lamps & Lighting Accessories	10	371
G4LED4	Lamps & Lighting Accessories	10	371
G918W	Lamps & Lighting Accessories	20	372
G928W	Lamps & Lighting Accessories	20	372
G942W	Lamps & Lighting Accessories	20	372
G9LED10	Lamps & Lighting Accessories	10	371
G9LED11	Lamps & Lighting Accessories	10	371
G9LED12	Lamps & Lighting Accessories	10	371
G9LED13	Lamps & Lighting Accessories	10	371
G9LED14	Lamps & Lighting Accessories	10	371
G9LED15	Lamps & Lighting Accessories	10	371
G9LED6	Lamps & Lighting Accessories	10	371
G9LED7	Lamps & Lighting Accessories	10	371
G9LED8	Lamps & Lighting Accessories	10	371
G9LED9	Lamps & Lighting Accessories	10	371
GBD4ESC	Lamps & Lighting Accessories	1	370
GBD4SESC	Lamps & Lighting Accessories	1	370
GDBOILBC	Flat Plate	1	74
GDBOILMB	Screwless	1	103
GDBOILMW	Screwless	1	103
GDBOILPC	Flat Plate	1	74
GDBOILU	Metal Clad	1	119
GDCL12BC	Raised Edge - Rounded	1	34
GDCL12PC	Raised Edge - Rounded	1	34
GDCL1BC	Raised Edge - Rounded	1	34
GDCL1PC	Raised Edge - Rounded	1	34
GDCL2BC	Raised Edge - Rounded	1	34
GDCL2PC	Raised Edge - Rounded	1	34
GDCL3BC	Raised Edge - Rounded	1	34
GDCL3PC	Raised Edge - Rounded	1	34
GDCL4BC	Raised Edge - Rounded	1	34
GDCL4PC	Raised Edge - Rounded	1	34
GDCL6BC	Raised Edge - Rounded	1	34
GDCL6PC	Raised Edge - Rounded	1	34
GDCL8BC	Raised Edge - Rounded	1	34
GDCL8PC	Raised Edge - Rounded	1	34
GDCL9BC	Raised Edge - Rounded	1	34
GDCL9PC	Raised Edge - Rounded	1	34
GDCOOKBC	Flat Plate	1	74
GDCOOKMB	Screwless	1	103
GDCOOKMW	Screwless	1	103
GDCOOKPC	Flat Plate	1	74
GDCOOKU	Metal Clad	1	119
GDCS12BC	Raised Edge - Square	1	49

G.

Code	Catalogue Section	Qty	Page
GDCS1BC	Raised Edge - Square	1	49
GDCS2BC	Raised Edge - Square	1	49
GDCS3BC	Raised Edge - Square	1	49
GDCS4BC	Raised Edge - Square	1	49
GDCS6BC	Raised Edge - Square	1	49
GDCS8BC	Raised Edge - Square	1	49
GDCS9BC	Raised Edge - Square	1	49
GDDISHBC	Flat Plate	1	74
GDDISHMB	Screwless	1	103
GDDISHMW	Screwless	1	103
GDDISHPC	Flat Plate	1	74
GDDISHU	Metal Clad	1	119
GDDRYBC	Flat Plate	1	74
GDDRYMB	Screwless	1	103
GDDRYMW	Screwless	1	103
GDDRYPC	Flat Plate	1	74
GDDRYU	Metal Clad	1	119
GDF001F	Raised Edge - Rounded	1	35
GDF002F	Raised Edge - Rounded	1	35
GDFANBC	Flat Plate	1	74
GDFANMB	Screwless	1	103
GDFANMW	Screwless	1	103
GDFANPC	Flat Plate	1	74
GDFANU	Metal Clad	1	119
GDFP0012M	Metal Clad	1	117
GDFP001BC	Flat Plate	1	72
GDFP001M	Metal Clad	1	117
GDFP001PC	Flat Plate	1	72
GDFP002BC	Flat Plate	1	72
GDFP002M	Metal Clad	1	117
GDFP002PC	Flat Plate	1	72
GDFP003BC	Flat Plate	1	72
GDFP003M	Metal Clad	1	117
GDFP003PC	Flat Plate	1	72
GDFP004BC	Flat Plate	1	72
GDFP004M	Metal Clad	1	117
GDFP004PC	Flat Plate	1	72
GDFP006BC	Flat Plate	1	72
GDFP006M	Metal Clad	1	117
GDFP006PC	Flat Plate	1	72
GDFP008BC	Flat Plate	1	72
GDFP008M	Metal Clad	1	117
GDFP008PC	Flat Plate	1	72
GDFP009BC	Flat Plate	1	72
GDFP009M	Metal Clad	1	117
GDFP009PC	Flat Plate	1	72
GDFP012BC	Flat Plate	1	72
GDFP012PC	Flat Plate	1	72
GDFRIDBC	Flat Plate	1	74
GDFRIDMB	Screwless	1	103
GDFRIDMW	Screwless	1	103
GDFRIDPC	Flat Plate	1	74
GDFRIDU	Metal Clad	1	119
GDHOBBC	Flat Plate	1	74
GDHOBMB	Screwless	1	103
GDHOBMW	Screwless	1	103

G.

Code	Catalogue Section	Qty	Page
GDHOBPC	Flat Plate	1	74
GDHOBUB	Metal Clad	1	119
GDKEY	Moulded Curved Edge	1	20
GDL1	Outdoor Wall Lights	1	259
GDL2	Bollard & Post Lighting	1	269
GDL3	Bollard & Post Lighting	1	269
GDLMK23	Bollard & Post Lighting	1	269
GDLSPIKE2	Bollard & Post Lighting	1	269
GDM001BC	Flat Plate	1	73
GDM001MB	Screwless	1	103
GDM001MW	Screwless	1	102
GDM001PC	Flat Plate	1	73
GDM001U	Metal Clad	1	118
GDM002BC	Flat Plate	1	73
GDM002MB	Screwless	1	102
GDM002MW	Screwless	1	102
GDM002PC	Flat Plate	1	73
GDM002U	Metal Clad	1	118
GDM003BC	Flat Plate	1	73
GDM003MB	Screwless	1	102
GDM003MW	Screwless	1	102
GDM003PC	Flat Plate	1	73
GDM003U	Metal Clad	1	118
GDM004BC	Flat Plate	1	73
GDM004MB	Screwless	1	102
GDM004MW	Screwless	1	102
GDM004PC	Flat Plate	1	73
GDM004U	Metal Clad	1	118
GDM005BC	Flat Plate	1	73
GDM005MB	Screwless	1	103
GDM005MW	Screwless	1	102
GDM005PC	Flat Plate	1	73
GDM005U	Metal Clad	1	118
GDM006BC	Flat Plate	1	73
GDM006MB	Screwless	1	102
GDM006MW	Screwless	1	102
GDM006PC	Flat Plate	1	73
GDM006U	Metal Clad	1	118
GDM007BC	Flat Plate	1	73
GDM007MB	Screwless	1	102
GDM007MW	Screwless	1	102
GDM007PC	Flat Plate	1	73
GDM007U	Metal Clad	1	118
GDM008BC	Flat Plate	1	73
GDM008MB	Screwless	1	102
GDM008MW	Screwless	1	102
GDM008PC	Flat Plate	1	73
GDM008U	Metal Clad	1	118
GDM009BC	Flat Plate	1	73
GDM009MB	Screwless	1	102
GDM009MW	Screwless	1	102
GDM009PC	Flat Plate	1	73
GDM009U	Metal Clad	1	118
GDM010BC	Flat Plate	1	73
GDM010MB	Screwless	1	102
GDM010MW	Screwless	1	102

G.			
Code	Catalogue Section	Qty	Page
GDM010PC	Flat Plate	1	73
GDM010U	Metal Clad	1	118
GDM011BC	Flat Plate	1	74
GDM011MB	Screwless	1	103
GDM011MW	Screwless	1	103
GDM011PC	Flat Plate	1	74
GDM011U	Metal Clad	1	119
GDM012BC	Flat Plate	1	74
GDM012MB	Screwless	1	103
GDM012MW	Screwless	1	103
GDM012PC	Flat Plate	1	74
GDM012U	Metal Clad	1	119
GDM013BC	Flat Plate	1	74
GDM013MB	Screwless	1	103
GDM013MW	Screwless	1	103
GDM013PC	Flat Plate	1	74
GDM013U	Metal Clad	1	119
GDM014MB	Screwless	1	102
GDM014MW	Screwless	1	102
GDM014PC	Flat Plate	1	73
GDM014U	Metal Clad	1	119
GDM016BC	Flat Plate	1	74
GDM016MB	Screwless	1	103
GDM016MW	Screwless	1	103
GDM016PC	Flat Plate	1	74
GDM016U	Metal Clad	1	119
GDM017	Flat Plate	1	74
GDM018	Flat Plate	1	74
GDM019	Flat Plate	1	74
GDM020BC	Flat Plate	1	74
GDM020MB	Screwless	1	102
GDM020MW	Screwless	1	102
GDM020PC	Flat Plate	1	74
GDM020U	Metal Clad	1	118
GDM021BC	Flat Plate	1	74
GDM021MB	Screwless	1	102
GDM021MW	Screwless	1	102
GDM021PC	Flat Plate	1	74
GDM021U	Metal Clad	1	118
GDM022BC	Flat Plate	1	74
GDM022MB	Screwless	1	103
GDM022MW	Screwless	1	103
GDM022PC	Flat Plate	1	74
GDM022U	Metal Clad	1	119
GDM200MB	Screwless	1	102
GDM200MW	Screwless	1	102
GDM200PC	Flat Plate	1	73
GDM200U	Metal Clad	1	119
GDMICROBC	Flat Plate	1	74
GDMICROMB	Screwless	1	103
GDMICROMW	Screwless	1	103
GDMICROPC	Flat Plate	1	74
GDMICROU	Metal Clad	1	119
GDOVENBC	Flat Plate	1	74
GDOVENMB	Screwless	1	103
GDOVENMW	Screwless	1	103

G.			
Code	Catalogue Section	Qty	Page
GDOVENPC	Flat Plate	1	74
GDOVENU	Metal Clad	1	119
GDS001F	Screwless	1	101
GDS002F	Screwless	1	101
GDS003F	Screwless	1	101
GDS004F	Screwless	1	101
GDSF001BC	Screwless	1	101
GDSF001MB	Screwless	1	101
GDSF001MW	Screwless	1	101
GDSF001PC	Screwless	1	101
GDSF002BC	Screwless	1	101
GDSF002MB	Screwless	1	101
GDSF002MW	Screwless	1	101
GDSF002PC	Screwless	1	101
GDSF003BC	Screwless	1	101
GDSF003MB	Screwless	1	101
GDSF003MW	Screwless	1	101
GDSF003PC	Screwless	1	101
GDSF004BC	Screwless	1	101
GDSF004MB	Screwless	1	101
GDSF004MW	Screwless	1	101
GDSF004PC	Screwless	1	101
GDSF006BC	Screwless	1	101
GDSF006MB	Screwless	1	101
GDSF006MW	Screwless	1	101
GDSF006PC	Screwless	1	101
GDSF008BC	Screwless	1	101
GDSF008MB	Screwless	1	101
GDSF008MW	Screwless	1	101
GDSF008PC	Screwless	1	101
GDSF009BC	Screwless	1	101
GDSF009MW	Screwless	1	101
GDSF009PC	Screwless	1	101
GDSF012BC	Screwless	1	101
GDSF012MW	Screwless	1	101
GDSF012PC	Screwless	1	101
GDSG68G	Wiring Basics	1	142
GDSG68M	Metal Clad	1	118
GDSG912G	Wiring Basics	1	142
GDSG912M	Metal Clad	1	118
GDWASHBC	Flat Plate	1	74
GDWASHMB	Screwless	1	103
GDWASHMW	Screwless	1	103
GDWASHPC	Flat Plate	1	74
GDWASHU	Metal Clad	1	119
GLSD8BC	Lamps & Lighting Accessories	1	370
GLSD8ESC	Lamps & Lighting Accessories	1	370
GROUN2	Outdoor Wall Lights	1	246
GSE225	Wiring Basics	5	142
GSE25	Wiring Basics	10	142
GSK16	Wiring Basics	20	142
GSK225	Wiring Basics	5	142
GSK235	Wiring Basics	5	142
GSK235D	Wiring Basics	5	142
GSK247	Wiring Basics	5	142
GSK25	Wiring Basics	10	142

G.			
Code	Catalogue Section	Qty	Page
GSK27	Wiring Basics	20	142
GSK298MM	Wiring Basics	1	142
GSK335	Wiring Basics	5	142
GSK335D	Wiring Basics	5	142
GSK35	Wiring Basics	10	142
GSK47	Wiring Basics	10	142
GU10SPIKE	Spike Lights	1	264
GU10SPIKEBK	Spike Lights	1	264
GU10SPIKEL	Spike Lights	1	264
GU5LCW	Lamps & Lighting Accessories	20	369
GU5LDCW	Lamps & Lighting Accessories	20	369
GU5LDDL	Lamps & Lighting Accessories	20	369
GU5LDL	Lamps & Lighting Accessories	20	369
GU5LDWW	Lamps & Lighting Accessories	20	369
GU5LWW	Lamps & Lighting Accessories	20	369
GUC5CW	Lamps & Lighting Accessories	20	369
GUC5DCW	Lamps & Lighting Accessories	20	369
GUC5DDL	Lamps & Lighting Accessories	20	369
GUC5DL	Lamps & Lighting Accessories	20	369
GUC5DWW	Lamps & Lighting Accessories	20	369
GUC5WW	Lamps & Lighting Accessories	20	369
GUSPBK	Spike Lights	1	265
GUSPGR	Spike Lights	1	265
GXLED3K	Lamps & Lighting Accessories	1	374
GXLED5K	Lamps & Lighting Accessories	1	374
H.			
Code	Catalogue Section	Qty	Page
HBLU1	High Bay / Low Bay	1	345
HBLU2	High Bay / Low Bay	1	345
HBN150	High Bay / Low Bay	1	344
HBN200	High Bay / Low Bay	1	344
HBNR1	High Bay / Low Bay	1	345
HBNR2	High Bay / Low Bay	1	345
HBNS1	High Bay / Low Bay	1	345
HCBC	Downlights	1	176
HCC	Downlights	1	176
HCW	Downlights	1	176
HEOD1309BK	Heating	1	279
HEOD1309W	Heating	1	279
HEOT1300W	Heating	1	279
HPLED1W	Groundlights & Deck Lighting	1	277
HS20MM	Wiring Basics	1	149
HS25MM	Wiring Basics	1	149
HS32MM	Wiring Basics	1	149
HS38MM	Wiring Basics	1	149
HS51MM	Wiring Basics	1	149
HS60MM	Wiring Basics	1	149
HS65MM	Wiring Basics	1	149
HS70MM	Wiring Basics	1	149
HS72MM	Wiring Basics	1	149
HS75MM	Wiring Basics	1	149
HS80MM	Wiring Basics	1	149
HS85MM	Wiring Basics	1	149
HS90MM	Wiring Basics	1	149
HSARBORL	Wiring Basics	1	149
HSARBORS	Wiring Basics	1	149

HSPILOTDB5 Wiring Basics			
Code	Catalogue Section	Qty	Page
ICEMC	Downlights	1	189
IN001	Additional Hardware	1	154
IN0010	Additional Hardware	1	154
IN0011	Additional Hardware	1	154
IN0012	Additional Hardware	1	154
IN0013	Additional Hardware	1	154
IN0014	Additional Hardware	1	155
IN0015	Additional Hardware	1	155
IN0016	Additional Hardware	1	155
IN0017	Additional Hardware	1	155
IN0018	Additional Hardware	1	155
IN0019	Additional Hardware	1	155
IN002	Additional Hardware	1	154
IN0020	Additional Hardware	1	155
IN0021	Additional Hardware	1	154
IN0022	Additional Hardware	1	154
IN0023	Additional Hardware	1	154
IN0025	Additional Hardware	1	155
IN0026	Additional Hardware	1	155
IN0027	Additional Hardware	1	155
IN003	Additional Hardware	1	154
IN004	Additional Hardware	1	154
IN005	Additional Hardware	1	154
IN006	Additional Hardware	1	154
IN007	Additional Hardware	1	154
IN008	Additional Hardware	1	154
IN009	Additional Hardware	1	154
IP3G	Weatherproof	1	135
IP5G	Weatherproof	1	135
IP663G	Weatherproof	1	135
IP665G	Weatherproof	1	135
IP68JBS	Lamps & Lighting Accessories	1	375
IP9000R	Weatherproof	1	135
IPRCB	Weatherproof	1	135
IPREMOTE	Weatherproof	1	135
J.			
Code	Catalogue Section	Qty	Page
JB0010	Weatherproof	1	136
JB0010BK	Weatherproof	1	136
JB0011	Weatherproof	1	137
JB002	Weatherproof	1	137
JB003	Weatherproof	1	137
JB004	Weatherproof	1	137
JB006	Weatherproof	1	137
JB007	Weatherproof	1	136
JB007BK	Weatherproof	1	136
JB008	Weatherproof	1	136
JB008BK	Weatherproof	1	136
JB009	Weatherproof	1	136
JB009BK	Weatherproof	1	136
JB55	Weatherproof	1	136
JB55BK	Weatherproof	1	136
K			
Code	Catalogue Section	Qty	Page
KIT16B	Groundlights & Deck Lighting	1	276

K.			
Code	Catalogue Section	Qty	Page
KIT16W	Groundlights & Deck Lighting	1	276
KIT16WW	Groundlights & Deck Lighting	1	276

L.			
Code	Catalogue Section	Qty	Page
L01C	Downlights	1	173
L01CBR	Downlights	1	173
L01W	Downlights	1	173
L02B1	Downlights	1	172
L02BK1	Downlights	1	172
L02C1	Downlights	1	172
L02CBR1	Downlights	1	172
L02W1	Downlights	1	172
L1000	Lamps & Lighting Accessories	50	372
L110	Lamps & Lighting Accessories	50	372
L120	Lamps & Lighting Accessories	50	372
L160	Lamps & Lighting Accessories	50	372
L230	Lamps & Lighting Accessories	50	372
L400	Lamps & Lighting Accessories	50	372
L80	Lamps & Lighting Accessories	50	372
LANT1	Outdoor Wall Lights	1	258
LANT1W	Outdoor Wall Lights	1	258
LANT2	Outdoor Wall Lights	1	258
LANT2W	Outdoor Wall Lights	1	258
LANT3	Outdoor Wall Lights	1	258
LANT3W	Outdoor Wall Lights	1	258
LANT4	Outdoor Wall Lights	1	258
LANT4W	Outdoor Wall Lights	1	258
LANTBK	Outdoor Wall Lights	1	257
LANTSS	Outdoor Wall Lights	1	257
LDGL5	Groundlights & Deck Lighting	1	275
LDGL6	Groundlights & Deck Lighting	1	275
LDGL9	Groundlights & Deck Lighting	1	275
LE04C1	Downlights	1	173
LE04W1	Downlights	1	173
LED100	Under Cabinet	1	223
LED1000	Under Cabinet	1	223
LED11WB	Under Cabinet	1	222
LED11WCW	Under Cabinet	1	222
LED11WWW	Under Cabinet	1	222
LED250	Under Cabinet	1	223
LED2500	Under Cabinet	1	223
LED3WB	Under Cabinet	1	222
LED3WCW	Under Cabinet	1	222
LED3WWW	Under Cabinet	1	222
LED5WB	Under Cabinet	1	222
LED5WCW	Under Cabinet	1	222
LED5WWW	Under Cabinet	1	222
LED8SPLIT	Under Cabinet	1	223
LEDAD36	Under Cabinet	1	223
LEDAD36W	Under Cabinet	1	223
LEDAMP	LED Flex	1	237
LEDBAT17	Battens	1	333
LEDBAT22	Battens	1	333
LEDBAT26	Battens	1	333
LEDBAT9	Battens	1	333
LEDBATW35	Battens	1	333

L.			
Code	Catalogue Section	Qty	Page
LEDBATW44	Battens	1	333
LEDBATW44EM	Battens	1	333
LEDBATW50	Battens	1	333
LEDBATW50EM	Battens	1	333
LEDDIMMER	Under Cabinet	1	223
LEDDIMMERW	Under Cabinet	1	221
LEDF12CHS	LED Flex	1	231
LEDF24CCT	LED Flex	1	231
LEDF24RGB	LED Flex	1	231
LEDF24RGBW	LED Flex	1	231
LEDFCLIP	Under Cabinet	1	222
LEDICON	Under Cabinet	1	222
LEDFH24DL	LED Flex	1	233
LEDFH24WW	LED Flex	1	233
LEDFIPCCT	LED Flex	1	232
LEDFIPDL	LED Flex	1	232
LEDFIPRGB	LED Flex	1	232
LEDFIPRGBW	LED Flex	1	232
LEDFIPWW	LED Flex	1	232
LEDFN12B	LED Flex	1	230
LEDFN12CW	LED Flex	1	230
LEDFN12DL	LED Flex	1	230
LEDFN12G	LED Flex	1	230
LEDFN12R	LED Flex	1	230
LEDFN12WW	LED Flex	1	230
LEDFN212DL	LED Flex	1	230
LEDFN212WW	LED Flex	1	230
LEDFN24DL	LED Flex	1	230
LEDFN24WW	LED Flex	1	230
LEDFR1	LED Flex	1	235
LEDFR2	LED Flex	1	235
LEDFR3	LED Flex	1	235
LEDFR4	LED Flex	1	235
LEDFR5	LED Flex	1	235
LEDFR6	LED Flex	1	235
LEDFR7	LED Flex	1	235
LEDFR8	LED Flex	1	235
LEDFS12DL	LED Flex	1	233
LEDFS12WW	LED Flex	1	233
LEDFWIFI	Smart Home	1	168
LEDGL3D	Groundlights & Deck Lighting	1	273
LEDGL3W	Groundlights & Deck Lighting	1	273
LEDM06B	Groundlights & Deck Lighting	1	276
LEDM06W	Groundlights & Deck Lighting	1	276
LEDM07B	Groundlights & Deck Lighting	1	274
LEDM07W	Groundlights & Deck Lighting	1	274
LEDM08B1	Groundlights & Deck Lighting	1	274
LEDM08W1	Groundlights & Deck Lighting	1	274
LEDPAN38	Recessed, Surface & Suspension	1	317
LEDRACON	Under Cabinet	1	222
LEDREC	Under Cabinet	1	225
LEDT11WCW	Under Cabinet	1	223
LEDT11WWW	Under Cabinet	1	223
LEDT3WCW	Under Cabinet	1	223
LEDT3WWW	Under Cabinet	1	223
LEDT5WCW	Under Cabinet	1	223



L.

Code	Catalogue Section	Qty	Page
LED75WWW	Under Cabinet	1	223
LED7CLIP	Under Cabinet	1	223
LED7CON	Under Cabinet	1	223
LED7D1	Under Cabinet	1	222
LED7D2	Under Cabinet	1	222
LED7RI	Under Cabinet	1	225
LG06C	Downlights	1	172
LG06CBR	Downlights	1	172
LG06W	Downlights	1	172
LH01	Lamps & Lighting Accessories	50	377
LH01C	Lamps & Lighting Accessories	50	377
LH02	Lamps & Lighting Accessories	50	377
LH03	Lamps & Lighting Accessories	50	377
LH04	Lamps & Lighting Accessories	50	377
LJ5002	Wiring Basics	1	150
LSC1	Lamps & Lighting Accessories	10	377
LSPIKEA	Spike Lights	1	267
LVC1	Lamps & Lighting Accessories	100	377
LVC2	Lamps & Lighting Accessories	100	377
LWALL1A	Outdoor Wall Lights	1	247
LWALL2A	Outdoor Wall Lights	1	247
LWALL3A	Outdoor Wall Lights	1	247
LWR2G	Outdoor Wall Lights	1	250
LWR2W	Outdoor Wall Lights	1	250
LWR4G	Outdoor Wall Lights	1	250
LWR4W	Outdoor Wall Lights	1	250
LWS2G	Outdoor Wall Lights	1	250
LWS2W	Outdoor Wall Lights	1	250
LWS4G	Outdoor Wall Lights	1	250
LWS4W	Outdoor Wall Lights	1	250

M.

Code	Catalogue Section	Qty	Page
M1100	Metal Clad	1	115
M1200	Metal Clad	1	115
M1G	Metal Clad	1	116
M2000	Metal Clad	1	115
M2G	Metal Clad	1	116
M3000	Metal Clad	1	115
M4000	Metal Clad	1	115
M4G	Metal Clad	1	116
M6000	Metal Clad	1	115
M6000N	Metal Clad	1	115
M6300	Metal Clad	1	115
M6300F	Metal Clad	1	115
M6300N	Metal Clad	1	115
M7300	Metal Clad	1	116
M7400	Metal Clad	1	116
M8331N	Metal Clad	1	116
M8332N	Metal Clad	1	116
M8341	Metal Clad	1	115
M8341N	Metal Clad	1	115
M8500	Metal Clad	1	116
M8600	Metal Clad	1	116
M8700	Metal Clad	1	118
M8900	Metal Clad	1	118
MR7000	Metal Clad	1	115

M.

Code	Catalogue Section	Qty	Page
MR7000U	Metal Clad	1	115
MR8333N	Metal Clad	1	116
MR9000	Metal Clad	1	115
MR9000U	Metal Clad	1	115
MR9124	Metal Clad	1	115
MR9224	Metal Clad	1	115
MRA436EMHF	Recessed, Surface & Suspension	1	318
MRA436HF	Recessed, Surface & Suspension	1	318
MRB418EMHF	Recessed, Surface & Suspension	1	318
MRB418HF	Recessed, Surface & Suspension	1	318
MRBLED	Recessed, Surface & Suspension	1	316
MRBLED6	Recessed, Surface & Suspension	1	316
MRD255PLHF	Recessed, Surface & Suspension	1	319
MRE255PLHF	Recessed, Surface & Suspension	1	319
MRJ45	Metal Clad	1	116
MSENSOR	Sensors	1	363

N.

Code	Catalogue Section	Qty	Page
NC65128HF	Non-corrosive	1	336
NC65135EMHF	Non-corrosive	1	336
NC65135HF	Non-corrosive	1	336
NC65228HF	Non-corrosive	1	336
NC65235EMHF	Non-corrosive	1	336
NC65235HF	Non-corrosive	1	336
NCLB12	Non-corrosive	1	338
NCLB14	Non-corrosive	1	338
NCLB15	Non-corrosive	1	338
NCLB16	Non-corrosive	1	338
NCLB22	Non-corrosive	1	338
NCLB24	Non-corrosive	1	338
NCLB25	Non-corrosive	1	338
NCLB26	Non-corrosive	1	338
NCLD36	Non-corrosive	1	342
NCLD36EM	Non-corrosive	1	342
NCLD36S	Non-corrosive	1	342
NCLD48	Non-corrosive	1	342
NCLD48EM	Non-corrosive	1	342
NCLD48S	Non-corrosive	1	342
NCLD60	Non-corrosive	1	342
NCLD60S	Non-corrosive	1	342
NCT5CLIP	Non-corrosive	20	336
NET13BK	Datacomms	1	125
NET13GY	Datacomms	1	125
NET13WH	Datacomms	1	125
NET16WH	Moulded Square Edge	1	11
NET24C5E	Datacomms	1	126
NET24C6	Datacomms	1	126
NET26WH	Moulded Square Edge	1	11
NET46WH	Moulded Square Edge	1	11
NET5ABK	Datacomms	1	125
NET5AGY	Datacomms	1	125
NET5AWH	Datacomms	1	125
NETBR1G	Datacomms	1	124
NETBR1GGY	Datacomms	1	124
NETBR1GW	Datacomms	1	124
NETBR2G	Datacomms	1	124

N.	Code	Catalogue Section	Qty	Page
	NETBR2GGY	Datacomms	1	124
	NETBR2GW	Datacomms	1	124
	NETBR4G	Datacomms	1	124
	NETBR4GGY	Datacomms	1	124
	NETBR4GW	Datacomms	1	124
	NETBTMBK	Datacomms	1	122
	NETBTMGY	Datacomms	1	122
	NETBTMWH	Datacomms	1	122
	NETBTSBK	Datacomms	1	122
	NETBTSGY	Datacomms	1	122
	NETBTSWH	Datacomms	1	122
	NETC510M	Datacomms	1	126
	NETC51M	Datacomms	1	126
	NETC53M	Datacomms	1	126
	NETC55M	Datacomms	1	126
	NETC5CP	Datacomms	1	126
	NETC610M	Datacomms	1	126
	NETC61M	Datacomms	1	126
	NETC63M	Datacomms	1	126
	NETC65M	Datacomms	1	126
	NETC6CP	Datacomms	1	126
	NETCAT5BK	Datacomms	1	122
	NETCAT5GY	Datacomms	1	122
	NETCAT5WH	Datacomms	1	122
	NETCAT6BK	Datacomms	1	122
	NETCAT6GY	Datacomms	1	122
	NETCAT6WH	Datacomms	1	122
	NETDISATBK	Datacomms	1	123
	NETDISATGY	Datacomms	1	123
	NETDISATWH	Datacomms	1	123
	NETDITVBK	Datacomms	1	123
	NETDITVGY	Datacomms	1	123
	NETDITVWH	Datacomms	1	123
	NETHBK	Datacomms	1	125
	NETHDMIBK	Datacomms	1	124
	NETHDMIGY	Datacomms	1	124
	NETHDMIWH	Datacomms	1	124
	NETHGY	Datacomms	1	125
	NETHWH	Datacomms	1	125
	NETQBK	Datacomms	1	125
	NETQDBK	Datacomms	1	123
	NETQDGY	Datacomms	1	123
	NETQDWH	Datacomms	1	123
	NETQGY	Datacomms	1	125
	NETQWH	Datacomms	1	125
	NETRJ11BK	Datacomms	1	122
	NETRJ11GY	Datacomms	1	122
	NETRJ11WH	Datacomms	1	122
	NETSATBK	Datacomms	1	122
	NETSATGY	Datacomms	1	122
	NETSATSBK	Datacomms	1	123
	NETSATSGY	Datacomms	1	123
	NETSATSWH	Datacomms	1	123
	NETSATWH	Datacomms	1	122
	NETTRIBK	Datacomms	1	123
	NETTRIGY	Datacomms	1	123

N.	Code	Catalogue Section	Qty	Page
	NETTRIWH	Datacomms	1	123
	NETTVBK	Datacomms	1	122
	NETTVGY	Datacomms	1	122
	NETTV5BK	Datacomms	1	123
	NETTV5GY	Datacomms	1	123
	NETTV5WH	Datacomms	1	123
	NETTVWH	Datacomms	1	122
	NETUSBBK	Datacomms	1	125
	NETUSBCBK	Datacomms	1	125
	NETUSBCGY	Datacomms	1	125
	NETUSBCWH	Datacomms	1	125
	NETUSBGY	Datacomms	1	125
	NETUSBWH	Datacomms	1	125
	NH0112DS	Outdoor Wall Lights	1	256
	NH016W	Outdoor Wall Lights	1	248
	NH017W	Outdoor Wall Lights	1	248
	NH0183BD	Ceiling & Wall Lights	1	204
	NH01845Q	Ceiling & Wall Lights	1	204
	NH019W	Outdoor Wall Lights	1	249
	NH020B	Outdoor Wall Lights	1	249
	NH020W	Outdoor Wall Lights	1	249
	NH021W	Outdoor Wall Lights	1	248
	NH022W	Outdoor Wall Lights	1	248
	NH023B	Ceiling & Wall Lights	1	205
	NH023W	Ceiling & Wall Lights	1	205
	NH025W	Ceiling & Wall Lights	1	205
	NH027	Outdoor Wall Lights	1	255
	NH027S	Outdoor Wall Lights	1	255
	NH028	Outdoor Wall Lights	1	255
	NH028S	Outdoor Wall Lights	1	255
	NSP1C	Ceiling & Wall Lights	1	199
	NSP3C	Ceiling & Wall Lights	1	199
	NSP4C	Ceiling & Wall Lights	1	199
	NSPGU1BC	Ceiling & Wall Lights	1	196
	NSPGU1C	Ceiling & Wall Lights	1	196
	NSPGU1W	Ceiling & Wall Lights	1	196
	NSPGU2BC	Ceiling & Wall Lights	1	196
	NSPGU2C	Ceiling & Wall Lights	1	196
	NSPGU3BC	Ceiling & Wall Lights	1	197
	NSPGU3C	Ceiling & Wall Lights	1	197
	NSPGU4BC	Ceiling & Wall Lights	1	197
	NSPGU4C	Ceiling & Wall Lights	1	197
	O.			
N.	Code	Catalogue Section	Qty	Page
	OL01B	Bollard & Post Lighting	1	268
	OL01P	Bollard & Post Lighting	1	268
	OL01W	Outdoor Wall Lights	1	259
	OP2	Weatherproof	1	134
	OP21	Weatherproof	1	134
	OP3	Weatherproof	1	134
	OP63N	Weatherproof	1	133
	OP6N	Weatherproof	1	133
	OP7N	Weatherproof	1	133
	OP9KW	Smart Home	1	165
	OP9N	Weatherproof	1	133
	OPRCDKIT	Weatherproof	1	133

O.

Code	Catalogue Section	Qty	Page
OS001	Sensors	1	364
OS0011	Sensors	1	362
OS0014	Sensors	1	364
OS0014B	Sensors	1	364
OS0016	Sensors	1	362
OS0019	Sensors	1	362
OS001B	Sensors	1	364
OS004	Sensors	1	364
OS004B	Sensors	1	364
OS006	Sensors	1	365
OS008	Sensors	1	363
OS009	Sensors	1	362
OS020	Sensors	1	365
OSEKW	Smart Home	1	166
OSMKW	Smart Home	1	166

P.

Code	Catalogue Section	Qty	Page
PIR0901	Sensors	1	363
PIR0901S	Sensors	1	363
PL18W4P	Lamps & Lighting Accessories	20	374
PL26W4P	Lamps & Lighting Accessories	20	374
PRCLED	Recessed, Surface & Suspension	1	321
PRCLED4	Recessed, Surface & Suspension	1	321
PRCLED4EM	Recessed, Surface & Suspension	1	321
PRCLED4EM4	Recessed, Surface & Suspension	1	321

R.

Code	Catalogue Section	Qty	Page
RCD001	Wiring Basics	1	147
RCD002	Wiring Basics	1	147
RCD6000	Wiring Basics	1	147
RCD9000	Wiring Basics	1	147
RCTM2LED	Bathroom	1	213
RCTM2T8	Bathroom	1	213
RCTRGB	Bathroom	1	213
RD10BK	Outdoor Wall Lights	1	253
RD1B	Downlights	1	174
RD1C	Downlights	1	174
RD1CBR	Downlights	1	174
RD1W	Downlights	1	174
RD2B	Downlights	1	174
RD2C	Downlights	1	174
RD2CBR	Downlights	1	174
RD2W	Downlights	1	174
RDL9CCT	Commercial Downlights	1	312
RDSHC	Downlights	1	175
RDSHCBR	Downlights	1	175
RDSHW	Downlights	1	175
RGBAMP	LED Flex	1	237
RW6BC	Downlights	1	186
RW6C	Downlights	1	186
RW6CCT	Downlights	1	186
RW6CW	Downlights	1	186
RW6DTW	Downlights	1	186
RW6FBC	Downlights	1	187
RW6FBR	Downlights	1	187
RW6FC	Downlights	1	187

R.

Code	Catalogue Section	Qty	Page
RW6FMB	Downlights	1	187
RW6FMW	Downlights	1	187
RW6KRGBW	Smart Home	1	166
RW6KW	Smart Home	1	166
RW6MB	Downlights	1	186
RW6MW	Downlights	1	186
RW6WW	Downlights	1	186
RWL2A	Outdoor Wall Lights	1	251
RWL2W	Outdoor Wall Lights	1	251
RWL5A	Outdoor Wall Lights	1	251
RWL5W	Outdoor Wall Lights	1	251

S.

Code	Catalogue Section	Qty	Page
SC15PA	Wiring Basics	10	148
SC30PA	Wiring Basics	10	148
SC3PA	Wiring Basics	10	148
SC5PA	Wiring Basics	10	148
SC60PA	Wiring Basics	10	148
SF0100BC	Screwless	1	98
SF0100BN	Screwless	1	98
SF0100MB	Screwless	1	98
SF0100MW	Screwless	1	98
SF0100PB	Screwless	1	98
SF0100PC	Screwless	1	98
SF0140BC	Screwless	1	99
SF0140BN	Screwless	1	99
SF0140MB	Screwless	1	99
SF0140MW	Screwless	1	99
SF0140PB	Screwless	1	99
SF0140PC	Screwless	1	99
SF0150BC	Screwless	1	99
SF0150BN	Screwless	1	99
SF0150MB	Screwless	1	99
SF0150MW	Screwless	1	99
SF0150PB	Screwless	1	99
SF0150PC	Screwless	1	99
SF1100BC	Screwless	1	89
SF1100BN	Screwless	1	89
SF1100MB	Screwless	1	89
SF1100MBB	Screwless	1	89
SF1100MW	Screwless	1	89
SF1100PB	Screwless	1	89
SF1100PC	Screwless	1	89
SF1200BC	Screwless	1	90
SF1200BN	Screwless	1	90
SF1200MB	Screwless	1	90
SF1200MBB	Screwless	1	90
SF1200MW	Screwless	1	90
SF1200PB	Screwless	1	90
SF1200PC	Screwless	1	90
SF12TOGBC	Screwless	1	92
SF12TOGBN	Screwless	1	92
SF12TOGPB	Screwless	1	92
SF12TOGPC	Screwless	1	92
SF1GBC	Screwless	1	100
SF1GBN	Screwless	1	100

S.			
Code	Catalogue Section	Qty	Page
SF1GMB	Screwless	1	100
SF1GMW	Screwless	1	100
SF1GPB	Screwless	1	100
SF1GPC	Screwless	1	100
SF1TOGBC	Screwless	1	92
SF1TOGBN	Screwless	1	92
SF1TOGPB	Screwless	1	92
SF1TOGPC	Screwless	1	92
SF2000BC	Screwless	1	90
SF2000BN	Screwless	1	90
SF2000MB	Screwless	1	90
SF2000MBB	Screwless	1	90
SF2000MW	Screwless	1	90
SF2000PB	Screwless	1	90
SF2000PC	Screwless	1	90
SF2181BC	Screwless	1	93
SF2181BN	Screwless	1	93
SF2181MB	Screwless	1	93
SF2181MBB	Screwless	1	93
SF2181MW	Screwless	1	93
SF2181PB	Screwless	1	93
SF2181PC	Screwless	1	93
SF2182BC	Screwless	1	93
SF2182BN	Screwless	1	93
SF2182MB	Screwless	1	93
SF2182MBB	Screwless	1	93
SF2182MW	Screwless	1	93
SF2182PB	Screwless	1	93
SF2182PC	Screwless	1	93
SF2183BC	Screwless	1	93
SF2183BN	Screwless	1	93
SF2183MB	Screwless	1	93
SF2183MBB	Screwless	1	93
SF2183MW	Screwless	1	93
SF2183PB	Screwless	1	93
SF2183PC	Screwless	1	93
SF2184BC	Screwless	1	94
SF2184BN	Screwless	1	94
SF2184MB	Screwless	1	94
SF2184MBB	Screwless	1	94
SF2184MW	Screwless	1	94
SF2184PB	Screwless	1	94
SF2184PC	Screwless	1	94
SF2GBC	Screwless	1	100
SF2GBN	Screwless	1	100
SF2GMB	Screwless	1	100
SF2GMW	Screwless	1	100
SF2GPB	Screwless	1	100
SF2GPC	Screwless	1	100
SF2TOGBC	Screwless	1	92
SF2TOGBN	Screwless	1	92
SF2TOGPB	Screwless	1	92
SF2TOGPC	Screwless	1	92
SF3000BC	Screwless	1	90
SF3000BN	Screwless	1	90
SF3000MB	Screwless	1	90

S.			
Code	Catalogue Section	Qty	Page
SF3000MBB	Screwless	1	90
SF3000MW	Screwless	1	90
SF3000PB	Screwless	1	90
SF3000PC	Screwless	1	90
SF3TOGBC	Screwless	1	92
SF3TOGBN	Screwless	1	92
SF3TOGPB	Screwless	1	92
SF3TOGPC	Screwless	1	92
SF4000BC	Screwless	1	91
SF4000BN	Screwless	1	91
SF4000MB	Screwless	1	91
SF4000MBB	Screwless	1	91
SF4000MW	Screwless	1	91
SF4000PB	Screwless	1	91
SF4000PC	Screwless	1	91
SF4100BC	Screwless	1	91
SF4100BN	Screwless	1	91
SF4100MB	Screwless	1	91
SF4100MBB	Screwless	1	91
SF4100MW	Screwless	1	91
SF4100PB	Screwless	1	91
SF4100PC	Screwless	1	91
SF4200BC	Screwless	1	91
SF4200BN	Screwless	1	91
SF4200MB	Screwless	1	91
SF4200MBB	Screwless	1	91
SF4200MW	Screwless	1	91
SF4200PB	Screwless	1	91
SF4200PC	Screwless	1	91
SF4GBC	Screwless	1	100
SF4GBN	Screwless	1	100
SF4GMB	Screwless	1	100
SF4GMW	Screwless	1	100
SF4GPB	Screwless	1	100
SF4GPC	Screwless	1	100
SF4TOGBC	Screwless	1	92
SF4TOGBN	Screwless	1	92
SF4TOGPB	Screwless	1	92
SF4TOGPC	Screwless	1	92
SF5ABC	Screwless	1	89
SF5ABCG	Screwless	1	89
SF5ABCW	Screwless	1	89
SF5ABN	Screwless	1	89
SF5AMB	Screwless	1	89
SF5AMW	Screwless	1	89
SF5APB	Screwless	1	89
SF5APBW	Screwless	1	89
SF5APC	Screwless	1	89
SF5APCW	Screwless	1	89
SF6000BC	Screwless	1	94
SF6000BN	Screwless	1	94
SF6000MB	Screwless	1	94
SF6000MBB	Screwless	1	94
SF6000MW	Screwless	1	94
SF6000PB	Screwless	1	94



S.

Code	Catalogue Section	Qty	Page
SF6000PC	Screwless	1	94
SF6300BC	Screwless	1	94
SF6300BN	Screwless	1	94
SF6300MB	Screwless	1	94
SF6300MBB	Screwless	1	94
SF6300MW	Screwless	1	94
SF6300NBC	Screwless	1	95
SF6300NBN	Screwless	1	95
SF6300NMB	Screwless	1	95
SF6300NMBB	Screwless	1	95
SF6300NMW	Screwless	1	95
SF6300NPB	Screwless	1	95
SF6300NPC	Screwless	1	95
SF6300PB	Screwless	1	94
SF6300PC	Screwless	1	94
SF7300BC	Screwless	1	98
SF7300BN	Screwless	1	98
SF7300MB	Screwless	1	98
SF7300MWB	Screwless	1	98
SF7300MW	Screwless	1	98
SF7300PB	Screwless	1	98
SF7300PC	Screwless	1	98
SF7400BC	Screwless	1	98
SF7400BN	Screwless	1	98
SF7400MB	Screwless	1	98
SF7400MW	Screwless	1	98
SF7400PB	Screwless	1	98
SF7400PC	Screwless	1	98
SF8331NBC	Screwless	1	97
SF8331NBN	Screwless	1	97
SF8331NMB	Screwless	1	97
SF8331NMW	Screwless	1	97
SF8331NPB	Screwless	1	97
SF8331NPC	Screwless	1	97
SF8332NBC	Screwless	1	97
SF8332NBN	Screwless	1	97
SF8332NMB	Screwless	1	97
SF8332NMW	Screwless	1	97
SF8332NPB	Screwless	1	97
SF8332NPC	Screwless	1	97
SF8341BC	Screwless	1	95
SF8341BN	Screwless	1	95
SF8341MB	Screwless	1	95
SF8341MBB	Screwless	1	95
SF8341MW	Screwless	1	95
SF8341NBC	Screwless	1	95
SF8341NBN	Screwless	1	95
SF8341NMB	Screwless	1	95
SF8341NMBB	Screwless	1	95
SF8341NMW	Screwless	1	95
SF8341NPB	Screwless	1	95
SF8341NPC	Screwless	1	95
SF8341PB	Screwless	1	95
SF8341PC	Screwless	1	95
SF8350BC	Screwless	1	99
SF8350BN	Screwless	1	99
SF8350MB	Screwless	1	99

S.

Code	Catalogue Section	Qty	Page
SF8350MW	Screwless	1	99
SF8350PB	Screwless	1	99
SF8350PC	Screwless	1	99
SF8360BC	Screwless	1	99
SF8360BN	Screwless	1	99
SF8360MB	Screwless	1	99
SF8360MW	Screwless	1	99
SF8360PB	Screwless	1	99
SF8360PC	Screwless	1	99
SF8900BC	Screwless	1	88
SF8900BCG	Screwless	1	88
SF8900BCW	Screwless	1	88
SF8900BN	Screwless	1	88
SF8900MB	Screwless	1	88
SF8900MW	Screwless	1	88
SF8900PB	Screwless	1	88
SF8900PBW	Screwless	1	88
SF8900PC	Screwless	1	88
SF8900PCG	Screwless	1	88
SF8900PCW	Screwless	1	88
SFBLUEBC	Screwless	1	86
SFBLUEMBB	Screwless	1	86
SFBLUEMW	Screwless	1	86
SFCARDBC	Screwless	1	96
SFPLBC	Screwless	1	96
SFPLMW	Screwless	1	96
SFQUADBC	Screwless	1	85
SFQUADBCG	Screwless	1	85
SFQUADBCW	Screwless	1	85
SFQUADBN	Screwless	1	85
SFQUADMB	Screwless	1	85
SFQUADMW	Screwless	1	85
SFQUADPB	Screwless	1	85
SFQUADPBW	Screwless	1	85
SFQUADPC	Screwless	1	85
SFQUADPCG	Screwless	1	85
SFQUADPCW	Screwless	1	85
SFR7000BC	Screwless	1	80
SFR7000BCG	Screwless	1	80
SFR7000BCW	Screwless	1	80
SFR7000BN	Screwless	1	80
SFR7000MB	Screwless	1	80
SFR7000MBB	Screwless	1	80
SFR7000MW	Screwless	1	80
SFR7000PB	Screwless	1	80
SFR7000PBW	Screwless	1	80
SFR7000PC	Screwless	1	80
SFR7000PCG	Screwless	1	80
SFR7000PCW	Screwless	1	80
SFR7USB4BC	Screwless	1	85
SFR7USB4BCG	Screwless	1	85
SFR7USB4BCW	Screwless	1	85
SFR7USB4BN	Screwless	1	85
SFR7USB4MB	Screwless	1	85
SFR7USB4MBB	Screwless	1	85
SFR7USB4MW	Screwless	1	85

S.			
Code	Catalogue Section	Qty	Page
SFR7USB4PB	Screwless	1	85
SFR7USB4PBW	Screwless	1	85
SFR7USB4PC	Screwless	1	85
SFR7USB4PCG	Screwless	1	85
SFR7USB4PCW	Screwless	1	85
SFR8333NBC	Screwless	1	97
SFR8333NBCG	Screwless	1	97
SFR8333NBCW	Screwless	1	97
SFR8333NBN	Screwless	1	97
SFR8333NMB	Screwless	1	97
SFR8333NMBB	Screwless	1	97
SFR8333NMW	Screwless	1	97
SFR8333NPB	Screwless	1	97
SFR8333NPBW	Screwless	1	97
SFR8333NPC	Screwless	1	97
SFR8333PCG	Screwless	1	97
SFR8333PCW	Screwless	1	97
SFR8333UBC	Screwless	1	84
SFR8333UBCG	Screwless	1	84
SFR8333UBCW	Screwless	1	84
SFR8333UMBB	Screwless	1	84
SFR8333UMW	Screwless	1	84
SFR9000BC	Screwless	1	80
SFR9000BCG	Screwless	1	80
SFR9000BCW	Screwless	1	80
SFR9000BN	Screwless	1	80
SFR9000MB	Screwless	1	80
SFR9000MBB	Screwless	1	80
SFR9000MW	Screwless	1	80
SFR9000PB	Screwless	1	80
SFR9000PBW	Screwless	1	80
SFR9000PC	Screwless	1	80
SFR9000PCG	Screwless	1	80
SFR9000PCW	Screwless	1	80
SFR9224BC	Screwless	1	81
SFR9224BCG	Screwless	1	81
SFR9224BCW	Screwless	1	81
SFR9224BN	Screwless	1	81
SFR9224MB	Screwless	1	81
SFR9224MBB	Screwless	1	81
SFR9224MW	Screwless	1	81
SFR9224PB	Screwless	1	81
SFR9224PBW	Screwless	1	81
SFR9224PC	Screwless	1	81
SFR9224PCG	Screwless	1	81
SFR9224PCW	Screwless	1	81
SFR9901BC	Screwless	1	81
SFR9901BCG	Screwless	1	81
SFR9901BCW	Screwless	1	81
SFR9901BN	Screwless	1	81
SFR9901MB	Screwless	1	81
SFR9901MBB	Screwless	1	81
SFR9901MW	Screwless	1	81
SFR9901PB	Screwless	1	81
SFR9901PBW	Screwless	1	81
SFR9901PC	Screwless	1	81

S.			
Code	Catalogue Section	Qty	Page
SFR9901PCG	Screwless	1	81
SFR9901PCW	Screwless	1	81
SFR9904NBC	Screwless	1	84
SFR9904NBCG	Screwless	1	84
SFR9904NBCW	Screwless	1	84
SFR9904NMBB	Screwless	1	84
SFR9904NMW	Screwless	1	84
SFR9905BC	Screwless	1	87
SFR9905BCG	Screwless	1	87
SFR9905BCW	Screwless	1	87
SFR9905MBB	Screwless	1	87
SFR9905MW	Screwless	1	87
SFR9906BC	Screwless	1	83
SFR9906BCG	Screwless	1	83
SFR9906BCW	Screwless	1	83
SFR9906MBB	Screwless	1	83
SFR9906MW	Screwless	1	83
SFR9907BC	Screwless	1	82
SFR9907BCG	Screwless	1	82
SFR9907BCW	Screwless	1	82
SFR9907MBB	Screwless	1	82
SFR9907MW	Screwless	1	82
SFRJ45BC	Screwless	1	98
SFRJ45BN	Screwless	1	98
SFRJ45MB	Screwless	1	98
SFRJ45MW	Screwless	1	98
SFRJ45PB	Screwless	1	98
SFRJ45PC	Screwless	1	98
SHE1B	Bulkheads & Wall Packs	1	302
SHE1BEM	Bulkheads & Wall Packs	1	302
SHE1BEMP	Bulkheads & Wall Packs	1	302
SHE1BEMS	Bulkheads & Wall Packs	1	302
SHE1BP	Bulkheads & Wall Packs	1	302
SHE1BS	Bulkheads & Wall Packs	1	302
SHE1G	Bulkheads & Wall Packs	1	302
SHE1GEM	Bulkheads & Wall Packs	1	302
SHE1GEMP	Bulkheads & Wall Packs	1	302
SHE1GEMS	Bulkheads & Wall Packs	1	302
SHE1GP	Bulkheads & Wall Packs	1	302
SHE1GS	Bulkheads & Wall Packs	1	302
SHE2B	Bulkheads & Wall Packs	1	303
SHE2BEM	Bulkheads & Wall Packs	1	303
SHE2BEMP	Bulkheads & Wall Packs	1	303
SHE2BEMS	Bulkheads & Wall Packs	1	303
SHE2BP	Bulkheads & Wall Packs	1	303
SHE2BS	Bulkheads & Wall Packs	1	303
SHE2G	Bulkheads & Wall Packs	1	303
SHE2GEM	Bulkheads & Wall Packs	1	303
SHE2GEMP	Bulkheads & Wall Packs	1	303
SHE2GEMS	Bulkheads & Wall Packs	1	303
SHE2GP	Bulkheads & Wall Packs	1	303
SHE2GS	Bulkheads & Wall Packs	1	303
SK0010	Specialist Sockets	1	110
SK0011	Specialist Sockets	1	110
SK0012	Specialist Sockets	1	111
SK0015	Specialist Sockets	1	111

S.			
Code	Catalogue Section	Qty	Page
SK004	Specialist Sockets	1	110
SK005A	Specialist Sockets	1	109
SK006	Specialist Sockets	1	109
SK007	Specialist Sockets	1	110
SKR0013	Specialist Sockets	1	109
SKR0014	Specialist Sockets	1	108
SKR001A	Specialist Sockets	1	109
SKR002A	Specialist Sockets	1	108
SKR003A	Specialist Sockets	1	111
SKR008	Specialist Sockets	1	108
SKR009A	Specialist Sockets	1	108
SL6USBC	Bathroom	1	209
SL6USBW	Bathroom	1	209
SLIGHT2	Bathroom	1	209
SLULED	Bathroom	1	210
SM314	Datacomms	1	126
SM315	Datacomms	1	126
SN0100	Moulded Square Edge	1	11
SN0110	Moulded Square Edge	1	11
SN0120	Moulded Square Edge	1	11
SN0140	Moulded Square Edge	1	11
SN1000	Moulded Square Edge	1	9
SN1100	Moulded Square Edge	1	9
SN1200	Moulded Square Edge	1	9
SN127	Moulded Square Edge	1	9
SN127P	Moulded Square Edge	10	11
SN1300	Moulded Square Edge	10	11
SN1315A	Wiring Basics	20	148
SN135A	Wiring Basics	20	148
SN1381	Wiring Basics	20	148
SN1382	Wiring Basics	20	148
SN1383	Wiring Basics	20	148
SN1383BK	Wiring Basics	20	148
SN13AFUSE	Wiring Basics	10	148
SN1400	Moulded Square Edge	10	11
SN1500	Moulded Square Edge	5	11
SN1510	Moulded Square Edge	5	11
SN1600	Moulded Square Edge	5	11
SN1610	Moulded Square Edge	10	11
SN1700	Moulded Square Edge	10	11
SN1800	Moulded Square Edge	5	11
SN1DIM	Moulded Square Edge	1	9
SN2000	Moulded Square Edge	1	9
SN2013B	Wiring Basics	10	147
SN2013W	Wiring Basics	10	147
SN2014B	Wiring Basics	10	147
SN2014W	Wiring Basics	10	147
SN2121B	Wiring Basics	1	147
SN2121W	Wiring Basics	1	147
SN2161	Moulded Square Edge	1	9
SN2162	Moulded Square Edge	1	9
SN2163	Moulded Square Edge	1	9
SN2164	Moulded Square Edge	1	9
SN2165	Moulded Square Edge	1	9
SN2DIM	Moulded Square Edge	1	9
SN3000	Moulded Square Edge	1	9

S.			
Code	Catalogue Section	Qty	Page
SN3AFUSE	Wiring Basics	10	148
SN4000	Moulded Square Edge	1	9
SN400M	Moulded Square Edge	1	9
SN4100	Moulded Square Edge	1	9
SN4200	Moulded Square Edge	1	9
SN5AFUSE	Wiring Basics	10	148
SN5U	Moulded Square Edge	1	8
SN6000	Moulded Square Edge	1	10
SN6000-3A	Moulded Square Edge	1	10
SN6000N	Moulded Square Edge	1	10
SN6300	Moulded Square Edge	1	10
SN6300N	Moulded Square Edge	1	10
SN7000	Moulded Square Edge	1	8
SN7000S	Moulded Square Edge	1	8
SN7000U	Moulded Square Edge	1	8
SN7300	Moulded Square Edge	1	11
SN7400	Moulded Square Edge	1	11
SN81BK	Wiring Basics	1	146
SN81WH	Wiring Basics	1	146
SN8200	Wiring Basics	10	146
SN8210	Wiring Basics	10	146
SN8220	Wiring Basics	10	146
SN8230	Wiring Basics	10	146
SN8250	Wiring Basics	20	146
SN8260	Wiring Basics	10	146
SN8270	Wiring Basics	10	144
SN8280	Wiring Basics	10	148
SN8290	Wiring Basics	5	146
SN8300	Wiring Basics	5	145
SN8310N	Wiring Basics	5	145
SN8331	Moulded Square Edge	1	10
SN8331N	Moulded Square Edge	1	10
SN8331NW	Moulded Square Edge	1	10
SN8331W	Moulded Square Edge	1	10
SN8332	Moulded Square Edge	1	10
SN8332N	Moulded Square Edge	1	10
SN8332NW	Moulded Square Edge	1	10
SN8332W	Moulded Square Edge	1	10
SN8333	Moulded Square Edge	1	10
SN8333N	Moulded Square Edge	1	10
SN8333NW	Moulded Square Edge	1	10
SN8333W	Moulded Square Edge	1	10
SN8335D	Wiring Basics	5	142
SN8340	Moulded Square Edge	1	10
SN8341	Moulded Square Edge	1	10
SN8341N	Moulded Square Edge	1	10
SN8342	Moulded Square Edge	1	10
SN8350	Moulded Square Edge	1	11
SN8360	Moulded Square Edge	1	11
SN8370	Wiring Basics	10	142
SN8375	Wiring Basics	10	142
SN8380	Wiring Basics	10	142
SN8380D	Wiring Basics	10	142
SN8381	Wiring Basics	10	142
SN8382	Wiring Basics	10	142
SN8400	Wiring Basics	20	143

S.				T.			
Code	Catalogue Section	Qty	Page	Code	Catalogue Section	Qty	Page
SN8400B	Wiring Basics	20	143	T5228	Battens	4	325
SN8410	Wiring Basics	20	143	T5228EM	Battens	1	325
SN8410B	Wiring Basics	20	143	T5235	Battens	4	325
SN8420	Wiring Basics	10	143	T5235EM	Battens	1	325
SN8420B	Wiring Basics	10	143	T5249	Battens	4	325
SN8430	Wiring Basics	10	143	T5249EM	Battens	1	325
SN8430B	Wiring Basics	10	143	T5DIF2	Battens	2	325
SN8460	Wiring Basics	10	143	T5DIF4	Battens	2	325
SN8460B	Wiring Basics	10	143	T5DIF5	Battens	2	325
SN8470	Wiring Basics	5	143	T8118HF	Battens	4	324
SN8470B	Wiring Basics	5	143	T8136EMHF	Battens	1	324
SN8900N	Moulded Square Edge	1	8	T8136HF	Battens	4	324
SN9000	Moulded Square Edge	1	8	T8158EMHF	Battens	1	324
SN9000S	Moulded Square Edge	1	8	T8158HF	Battens	4	324
SN9000U	Moulded Square Edge	1	8	T8170EMHF	Battens	1	324
SN9000UR	Moulded Square Edge	1	8	T8170HF	Battens	4	324
SN9903	Moulded Square Edge	1	8	T8218HF	Battens	4	324
SN9904	Moulded Square Edge	1	8	T8236EMHF	Battens	1	324
SN9KW	Smart Home	1	164	T8236HF	Battens	4	324
SNEB1	Wiring Basics	10	143	T8258EMHF	Battens	1	324
SNEB2	Wiring Basics	10	143	T8258HF	Battens	4	324
SNMIXEDFUSE	Wiring Basics	10	148	T8270EMHF	Battens	1	324
SPIKE4BL	Spike Lights	1	266	T8270HF	Battens	4	324
SPIKE50BL	Spike Lights	1	265	T8BLED12	Battens	1	328
SPIKE5A	Spike Lights	1	266	T8BLED14	Battens	1	328
SPIKE5S	Spike Lights	1	267	T8BLED15	Battens	1	328
SPIKEGUBK	Spike Lights	1	264	T8BLED15EM1	Battens	1	328
SPIKEW	Spike Lights	1	267	T8BLED16	Battens	1	328
SPIKEXT	Spike Lights	1	265	T8BLED16EM1	Battens	1	328
SPIKEXT1	Spike Lights	1	265	T8BLED22	Battens	1	329
ST6ABK	Wiring Basics	10	146	T8BLED24	Battens	1	329
ST6AWH	Wiring Basics	10	146	T8BLED25	Battens	1	329
SURF236EMHF	Recessed, Surface & Suspension	1	320	T8BLED25EM1	Battens	1	329
SURF236HF	Recessed, Surface & Suspension	1	320	T8BLED25HL	Battens	1	329
SURF258EMHF	Recessed, Surface & Suspension	1	320	T8BLED25HLEM	Battens	1	329
SURF258HF	Recessed, Surface & Suspension	1	320	T8BLED26	Battens	1	329
SURF270EMHF	Recessed, Surface & Suspension	1	320	T8BLED26EM1	Battens	1	329
SURF270HF	Recessed, Surface & Suspension	1	320	T8BLED26HL	Battens	1	329
SURF414EMHF	Recessed, Surface & Suspension	1	320	T8BLED26HLEM	Battens	1	329
SURF414HF	Recessed, Surface & Suspension	1	320	T8DIFF136	Battens	2	324
SURF418EMHF	Recessed, Surface & Suspension	1	319	T8DIFF158	Battens	2	324
SURF418HF	Recessed, Surface & Suspension	1	319	T8DIFF170	Battens	2	324
SWS01C	Downlights	1	175	T8DIFF236	Battens	2	324
SWS01W	Downlights	1	175	T8DIFF258	Battens	2	324
T.				T8DIFF270	Battens	2	324
Code	Catalogue Section	Qty	Page	T8LB14	Battens	4	326
T02	Lamps & Lighting Accessories	1	375	T8LB15	Battens	4	326
T03	Lamps & Lighting Accessories	1	375	T8LB16	Battens	4	326
T5114	Battens	4	325	T8LB24	Battens	4	326
T5128	Battens	4	325	T8LB25	Battens	4	326
T5128EM	Battens	1	325	T8LB26	Battens	4	326
T5135	Battens	4	325	T8LED6	Battens	1	326
T5135EM	Battens	1	325	T8LED6D	Battens	1	326
T5149	Battens	4	325	T8LEDP18CW	Battens	1	326
T5149EM	Battens	1	325	T8LEDP18DL	Battens	1	326
T5214	Battens	4	325	T8LEDP24CW	Battens	1	326



T.

Code	Catalogue Section	Qty	Page
T8LEDP24DL	Battens	1	326
T8LEDP9CW	Battens	1	326
T8LEDP9DL	Battens	1	326
T8REF36	Battens	4	324
T8REF58	Battens	4	324
T8REF70	Battens	4	324
TE1	Wiring Basics	1	150
TE2	Wiring Basics	1	150
TE3	Wiring Basics	1	150
TE4	Wiring Basics	1	150
TE5	Wiring Basics	1	150
TPB14EMLED	Bulkheads & Wall Packs	1	300
TPB14EMSLED	Bulkheads & Wall Packs	1	300
TPB14LED	Bulkheads & Wall Packs	1	300
TPB14LEDA	Bulkheads & Wall Packs	1	300
TPB14SLED	Bulkheads & Wall Packs	1	300
TPB16BRRG	Bulkheads & Wall Packs	1	292
TPB16CHRG	Bulkheads & Wall Packs	1	292
TPB16WOHF	Bulkheads & Wall Packs	1	292
TPB16WPHF	Bulkheads & Wall Packs	1	292
TPB28WOEMHF	Bulkheads & Wall Packs	1	292
TPB28WOHF	Bulkheads & Wall Packs	1	292
TPB28WPEMHF	Bulkheads & Wall Packs	1	292
TPB28WPHF	Bulkheads & Wall Packs	1	292
TPB33BRRG	Bulkheads & Wall Packs	1	292
TPB33CHRG	Bulkheads & Wall Packs	1	292
TPOV60B	Bulkheads & Wall Packs	1	305
TPOV60W	Bulkheads & Wall Packs	1	305
TPR14LED	Bulkheads & Wall Packs	1	300
TPR14LEDA	Bulkheads & Wall Packs	1	300
TPR14LEDEM	Bulkheads & Wall Packs	1	300
TPR14LEDS	Bulkheads & Wall Packs	1	300
TPR16WOHF	Bulkheads & Wall Packs	1	293
TPR16WPHF	Bulkheads & Wall Packs	1	293
TPR28BPHF	Bulkheads & Wall Packs	1	293
TPR28WPHF	Bulkheads & Wall Packs	1	293
TPRWOEMHF	Bulkheads & Wall Packs	1	293
TPRWOHF	Bulkheads & Wall Packs	1	293
TPRWPEMHF	Bulkheads & Wall Packs	1	293
TPS28BOEMHF	Bulkheads & Wall Packs	1	294
TPS28BOHF	Bulkheads & Wall Packs	1	294
TPS28BPEMHF	Bulkheads & Wall Packs	1	294
TPS28BPHF	Bulkheads & Wall Packs	1	294
TPS28WOEMHF	Bulkheads & Wall Packs	1	294
TPS28WOHF	Bulkheads & Wall Packs	1	294
TPS28WPEMHF	Bulkheads & Wall Packs	1	294
TPS28WPHF	Bulkheads & Wall Packs	1	294
TR150HQI	Floodlights	1	288
TR250SLB	High Bay / Low Bay	1	345
TR400SLB	High Bay / Low Bay	1	345
TRHP70	Floodlights	1	288
TRHP70PC	Floodlights	1	288
TRIBCCW	Under Cabinet	1	224
TRIBCWW	Under Cabinet	1	224
TRK1MBK	Ceiling & Wall Lights	1	203

T.

Code	Catalogue Section	Qty	Page
TRK1MS	Ceiling & Wall Lights	1	203
TRK1MW	Ceiling & Wall Lights	1	203
TRK2MBK	Ceiling & Wall Lights	1	203
TRK2MS	Ceiling & Wall Lights	1	203
TRK2MW	Ceiling & Wall Lights	1	203
TRK3MBK	Ceiling & Wall Lights	1	203
TRK3MS	Ceiling & Wall Lights	1	203
TRK3MW	Ceiling & Wall Lights	1	203
TRKADBK	Ceiling & Wall Lights	1	203
TRKADS	Ceiling & Wall Lights	1	203
TRKADW	Ceiling & Wall Lights	1	203
TRKCBK	Ceiling & Wall Lights	1	203
TRKCS	Ceiling & Wall Lights	1	203
TRKCW	Ceiling & Wall Lights	1	203
TRKDEBK	Ceiling & Wall Lights	1	203
TRKDES	Ceiling & Wall Lights	1	203
TRKDEW	Ceiling & Wall Lights	1	203
TRKFCEBK	Ceiling & Wall Lights	1	203
TRKFCS	Ceiling & Wall Lights	1	203
TRKFCW	Ceiling & Wall Lights	1	203
TRKLCBK	Ceiling & Wall Lights	1	203
TRKLCS	Ceiling & Wall Lights	1	203
TRKLCW	Ceiling & Wall Lights	1	203
TRKPFBK	Ceiling & Wall Lights	1	203
TRKPFCS	Ceiling & Wall Lights	1	203
TRKPFW	Ceiling & Wall Lights	1	203
TRKRABK	Ceiling & Wall Lights	1	203
TRKRAS	Ceiling & Wall Lights	1	203
TRKRAW	Ceiling & Wall Lights	1	203
TRKSP1BC	Ceiling & Wall Lights	1	200
TRKSP1BK	Ceiling & Wall Lights	1	200
TRKSP1W	Ceiling & Wall Lights	1	200
TRKSP2BC	Ceiling & Wall Lights	1	200
TRKSP2BK	Ceiling & Wall Lights	1	200
TRKSP2W	Ceiling & Wall Lights	1	200
TRKSP3BC	Ceiling & Wall Lights	1	200
TRKSP3BK	Ceiling & Wall Lights	1	200
TRKSP3W	Ceiling & Wall Lights	1	200
TRKSP4BC	Ceiling & Wall Lights	1	201
TRKSP4BK	Ceiling & Wall Lights	1	201
TRKSP4W	Ceiling & Wall Lights	1	201
TRKSP5BC	Ceiling & Wall Lights	1	201
TRKSP5BK	Ceiling & Wall Lights	1	201
TRKSP5W	Ceiling & Wall Lights	1	201
TRKSP6BC	Ceiling & Wall Lights	1	201
TRKSP6BK	Ceiling & Wall Lights	1	201
TRKSP6W	Ceiling & Wall Lights	1	201
TRKSP7BCCW	Ceiling & Wall Lights	1	202
TRKSP7BCW	Ceiling & Wall Lights	1	202
TRKSP7BCWW	Ceiling & Wall Lights	1	202
TRKSP7BWW	Ceiling & Wall Lights	1	202
TRKSP7R	Ceiling & Wall Lights	1	202
TRKSP7WCW	Ceiling & Wall Lights	1	202
TRKSP7WWW	Ceiling & Wall Lights	1	202
TRKSP8B	Ceiling & Wall Lights	1	201

T.			
Code	Catalogue Section	Qty	Page
TRKSP8BC	Ceiling & Wall Lights	1	201
TRKSP8W	Ceiling & Wall Lights	1	201
TRKTBK	Ceiling & Wall Lights	1	203
TRKTS	Ceiling & Wall Lights	1	203
TRKTW	Ceiling & Wall Lights	1	203
TRKXBK	Ceiling & Wall Lights	1	203
TRKXS	Ceiling & Wall Lights	1	203
TRKXW	Ceiling & Wall Lights	1	203
TRLED12	Non-corrosive	1	340
TRLED14	Non-corrosive	1	340
TRLED14EM	Non-corrosive	1	340
TRLED15	Non-corrosive	1	340
TRLED151	Non-corrosive	1	340
TRLED151EM	Non-corrosive	1	340
TRLED15D	Non-corrosive	1	340
TRLED15EM	Non-corrosive	1	340
TRLED15EMD	Non-corrosive	1	340
TRLED16	Non-corrosive	1	340
TRLED16D	Non-corrosive	1	340
TRLED16EM	Non-corrosive	1	340
TRLED16EMD	Non-corrosive	1	340
TRLED22	Non-corrosive	1	341
TRLED221	Non-corrosive	1	341
TRLED221EM	Non-corrosive	1	341
TRLED24	Non-corrosive	1	341
TRLED24EM	Non-corrosive	1	341
TRLED25	Non-corrosive	1	341
TRLED25D	Non-corrosive	1	341
TRLED25EM	Non-corrosive	1	341
TRLED25EMD	Non-corrosive	1	341
TRLED26	Non-corrosive	1	341
TRLED26D	Non-corrosive	1	341
TRLED26EM	Non-corrosive	1	341
TRLED26EMD	Non-corrosive	1	341
TRPCKIT	Sensors	1	365
TRRPC	Sensors	1	365

U.			
Code	Catalogue Section	Qty	Page
UC1000	Under Cabinet	1	219
UC250	Under Cabinet	1	219
UC500	Under Cabinet	1	219
UCCUP	Under Cabinet	1	219
UCL12CW	Under Cabinet	1	221
UCL12WW	Under Cabinet	1	221
UCL4CW	Under Cabinet	1	221
UCL4WW	Under Cabinet	1	221
UCL6CW	Under Cabinet	1	221
UCL6WW	Under Cabinet	1	221
UCLCB	Under Cabinet	1	221
UCLCP	Under Cabinet	1	221
UCLCT13	Under Cabinet	1	219
UCLCT18	Under Cabinet	1	219
UCLCT4	Under Cabinet	1	219
UCLCT9	Under Cabinet	1	219
UCLED13CW	Under Cabinet	2	219
UCLED13WW	Under Cabinet	2	219

U.			
Code	Catalogue Section	Qty	Page
UCLED18CW	Under Cabinet	2	219
UCLED18WW	Under Cabinet	2	219
UCLED22CW	Under Cabinet	2	219
UCLED22WW	Under Cabinet	2	219
UCLED4CW	Under Cabinet	1	219
UCLED4WW	Under Cabinet	1	219
UCLED7CW	Under Cabinet	1	219
UCLED7WW	Under Cabinet	1	219
UCLED9CW	Under Cabinet	1	219
UCLED9WW	Under Cabinet	1	219
UCLJB	Under Cabinet	1	221
UCLOE	Under Cabinet	1	221
UCLOS	Under Cabinet	1	221
UCLTD	Under Cabinet	1	221
UCP200	Under Cabinet	1	219
UNDK3BCCW	Under Cabinet	1	226
UNDK3BCWW	Under Cabinet	1	226
UNDK3WCW	Under Cabinet	1	226
UNDK3WWW	Under Cabinet	1	226
UNDKCON	Under Cabinet	1	226
UNDKIT3BCCW	Under Cabinet	1	226
UNDKIT3BCWW	Under Cabinet	1	226
UNDKIT3WCW	Under Cabinet	1	226
UNDKIT3WWW	Under Cabinet	1	226
USLED12	Under Cabinet	1	220
USLED123K	Under Cabinet	1	220
USLED7	Under Cabinet	1	220
USLED73K	Under Cabinet	1	220

V.			
Code	Catalogue Section	Qty	Page
VFCFBC	Downlights	1	178
VFCFC	Downlights	1	178
VFCFIPBC	Downlights	1	179
VFCFIPC	Downlights	1	179
VFCFIPW	Downlights	1	179
VFCFTBC	Downlights	1	179
VFCFTC	Downlights	1	179
VFCFTW	Downlights	1	179
VFCFW	Downlights	1	178
VFR200M	Moulded Square Edge	1	9
VFR7EM	Downlights	1	189
VFR8BEZBL	Downlights	1	190
VFR8BEZBR	Downlights	1	190
VFR8BEZCBR	Downlights	1	190
VFR8BEZCH	Downlights	1	190
VFR8BEZMW	Downlights	1	190
VFR8CW	Downlights	1	190
VFR8TBEZBL	Downlights	1	191
VFR8TBEZBR	Downlights	1	191
VFR8TBEZCBR	Downlights	1	191
VFR8TBEZCH	Downlights	1	191
VFR8TBEZMW	Downlights	1	191
VFR8TCW	Downlights	1	191
VFR8TWW	Downlights	1	191
VFR8WW	Downlights	1	190
VFRBEZAB	Downlights	1	192



V.

Code	Catalogue Section	Qty	Page
VFRBEZBK	Downlights	1	192
VFRBEZBR	Downlights	1	192
VFRBEZCBR	Downlights	1	192
VFRBEZCH	Downlights	1	192
VFRBEZGM	Downlights	1	192
VFRBEZW	Downlights	1	192
VFRBCB	Downlights	1	193
VFRCC	Downlights	1	193
VFRCOBCW	Downlights	1	192
VFRCOBCW1	Downlights	1	177
VFRCOBCW2	Downlights	1	177
VFRCOBCW3	Downlights	1	177
VFRCOBWW	Downlights	1	192
VFRCOBWW1	Downlights	1	177
VFRCOBWW2	Downlights	1	177
VFRCOBWW3	Downlights	1	177
VFRCW	Downlights	1	193
VFRDGICB	Downlights	1	180
VFRDGICC	Downlights	1	180
VFRDGICCBR	Downlights	1	180
VFRDGICW	Downlights	1	180
VFRIC8CW	Downlights	1	188
VFRIC8TCW	Downlights	1	189
VFRIC8TWW	Downlights	1	189
VFRIC8WW	Downlights	1	188
VFRICBEZC	Downlights	1	188
VFRICBEZCBR	Downlights	1	188
VFRICBEZW	Downlights	1	188
VFRICC	Downlights	1	188
VFRICTBEZC	Downlights	1	189
VFRICTBEZCBR	Downlights	1	189
VFRICTBEZW	Downlights	1	189
VFRICTC	Downlights	1	189
VFRSBEZBK	Downlights	1	192
VFRSBEZCBR	Downlights	1	192
VFRSBEZCH	Downlights	1	192
VFRSBEZW	Downlights	1	192
VFRSGICB	Downlights	1	180
VFRSGICC	Downlights	1	180
VFRSGICCBR	Downlights	1	180
VFRSGICW	Downlights	1	180
VFRSHGICB	Downlights	1	181
VFRSHGICC	Downlights	1	181
VFRSHGICCBR	Downlights	1	181
VFRSHGICW	Downlights	1	181
VML1	Bathroom	1	212

W.

Code	Catalogue Section	Qty	Page
WAD12A	Outdoor Wall Lights	1	252
WAD12BK	Outdoor Wall Lights	1	252
WALL1	Outdoor Wall Lights	1	246
WALL1L	Outdoor Wall Lights	1	244
WALL1LBK	Outdoor Wall Lights	1	244
WALL1LC	Outdoor Wall Lights	1	244
WALL2	Outdoor Wall Lights	1	246
WALL2L	Outdoor Wall Lights	1	244

W.

Code	Catalogue Section	Qty	Page
WALL2LBK	Outdoor Wall Lights	1	244
WALL2LC	Outdoor Wall Lights	1	244
WALL3	Outdoor Wall Lights	1	246
WALL3L	Outdoor Wall Lights	1	244
WALL3LBK	Outdoor Wall Lights	1	244
WALL3LC	Outdoor Wall Lights	1	244
WALL4LSS	Outdoor Wall Lights	1	245
WALL5LSS	Outdoor Wall Lights	1	245
WD12BC	Smart Home	1	168
WD12RGBW	Smart Home	1	168
WGULED	Groundlights & Deck Lighting	1	272
WGULEN	Groundlights & Deck Lighting	1	272
WHGULED	Groundlights & Deck Lighting	1	272
WP15CTP	Bulkheads & Wall Packs	1	306
WPTCP	Bulkheads & Wall Packs	1	306
WSGULED	Groundlights & Deck Lighting	1	272
WSM16A	Outdoor Wall Lights	1	243
WSM16BC	Outdoor Wall Lights	1	243
WSM16W	Outdoor Wall Lights	1	243
WSS8A	Outdoor Wall Lights	1	243
WSS8BC	Outdoor Wall Lights	1	243
WSS8W	Outdoor Wall Lights	1	243
WW15C	Commercial Downlights	1	312
WW30R	Commercial Downlights	1	313
WW40C	Commercial Downlights	1	312
WW40R	Commercial Downlights	1	313
X			
Code	Catalogue Section	Qty	Page
XT468	Wiring Basics	1	150
XT901BX	Wiring Basics	1	150

**“committed to
a brighter future”**

www.mlaccessories.co.uk

